

# Test Probes Catalog 2013/2014



Automotive



Telecommunications



Information Electronics



Engineering

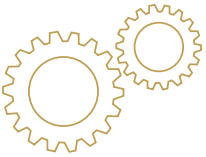

Consumer Electronics



Energy supply

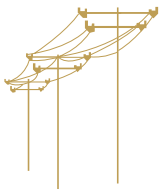

Aviation and space technology



Medical



## Competent in your field

**Your requirements are getting more demanding;  
we will support you with specialized solutions.**

With more than 20,000 variants we offer you our comprehensive assortment in proven quality:

- For **ICT/FCT** we offer you the worldwide largest variety of variants in regard to series, tip-styles and spring-forces.
- In **Cable Harness Test** we guaranty you the best contact to your connections.
- For high-frequency and digital signals we recommend our **RF Probes**.
- Testing highest currents in in the smallest spacing with low-ohm **High-current Probes**.
- Our choice of spring-loaded **Switching Probes** ensures simple switching.
- The **Pneumatic Probes** from INGUN offer unbeatable versatility.

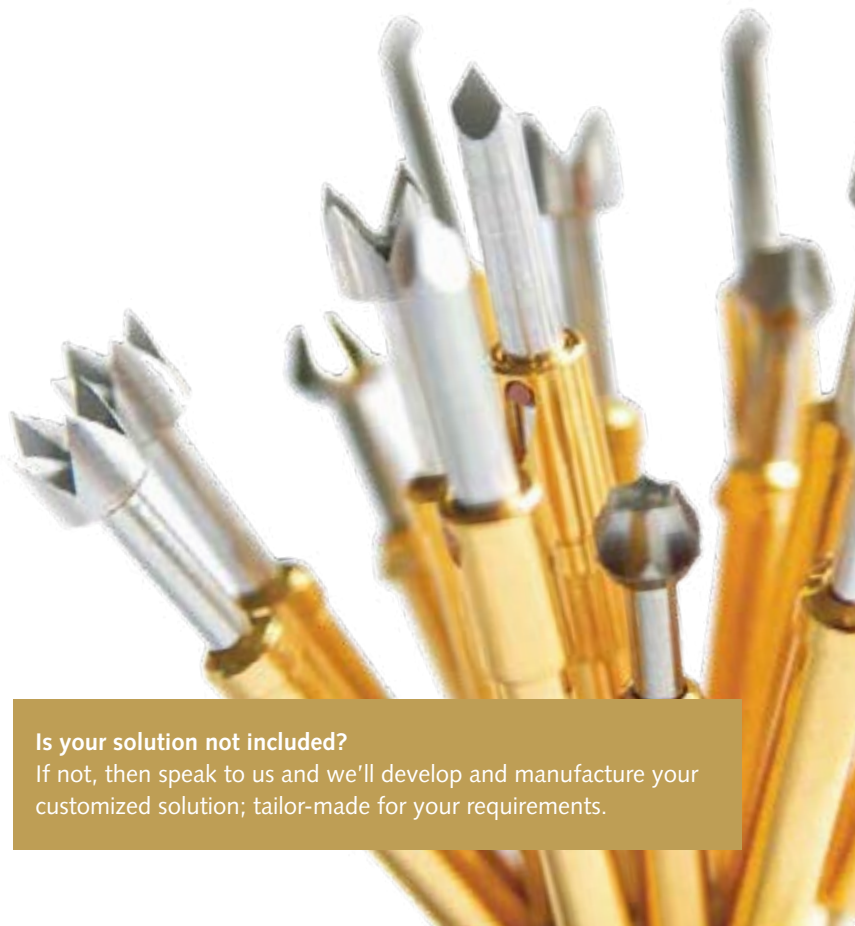

**Is your solution not included?**

If not, then speak to us and we'll develop and manufacture your customized solution; tailor-made for your requirements.

# Contents: Test Probes

Grid in mm (Mil)	Recommended Stroke in mm	Max. Stroke in mm	Current Rating in A	ICT / FCT	Combined ICT-/FCT-Test	Cable Harness Probes	Solderable Probes	Battery Probes	Micro-Contacting	RF-Applications	High-Current Applications	High Temperature Range	Component Presence Check	Individually controllable Probes	Interface Probes	Low Installation Height	High Installation Height	Short-stroke Probes	Long-stroke Probes	Through (continuous) Plunger	Non-Rotating Probes	Rotating Probes	High Spring Forces	Stroke-measurement Probes	Series	Page			
<b>e-type® Probes</b>																													
1,27	4,3	6,4	2 – 3	●																					E-050	20	NEW		
1,91	4,3	6,4	3 – 4	●																					E-075	20	NEW		
2,54	4,3	6,4	5 – 8	●																					E-100	21	NEW		
2,54	6,4	8	5 – 8	●	●																				E-422	21	NEW		
<b>In-Circuit / Functional Test (ICT/FCT)</b>																													
1	4,3	6,35	2	●					●																	GKS-040	24		
1,27	4,3	6,35	2 – 3	●	●							●														GKS-050	25		
1,27	8	10	2 – 3	●	●												●		●							GKS-015	25		
1,91	4,3	6,35	3 – 4	●	●							●	●												●	GKS-075	26		
1,91	4,3	6,35	3 – 4	●	●							●	●												●	GKS-075	27		
2,54	4,3	6,35	5 – 8	●	●							●	●												●	GKS-100	28		
2,54	4,3	6,35	5 – 8	●	●							●	●												●	GKS-100	29	NEW	
1,91	8	10	3 – 4	●	●												●		●							GKS-035	30		
2,54	9,3	11,5	5 – 8	●	●												●		●							GKS-135	31		
1,91	4	5,3	3 – 4	●								●														GKS-101	32		
1,91	2	2,4	3 – 4	●	●	●										●										GKS-001	33		
2,54	2,7	4,1	5 – 8	●	●	●										●										GKS-002	34		
3,18	4,4	6,35	6	●	●	●										●										GKS-003	35		
4,75	4,4	6,35	7	●	●	●																				GKS-004	36		
4,75	4,4	6,35	8	●	●	●																		●		GKS-005	37		
1			2																							KS-040 WL	38		
1,27			3																							KS-550 WL	38		
1,91			4																							KS-075 WL	38		
2,54			5																							KS-100 WL	38		
1,27	4,3	6,35	2 – 3																							GKS-550	38		
<b>Bead Probes</b>																													
1,27	4,3	6,35	2 – 3	●	●																						GKS-050	40	NEW
1,91	4,3	6,35	3 – 4	●	●																						GKS-075	40	NEW
2,54	4,3	6,35	5 – 8	●	●																						GKS-100	40	NEW
2,54	9,3	11,7	5 – 8	●	●												●		●								GKS-135	40	NEW
<b>Fine Pitch (≤1,27 mm)</b>																													
0,635	2	2,5	1													●		●									GKS-038	42	
0,7	2,5	3,5	2													●		●									GKS-041	42	
0,8	2,5	3,5	2													●		●									GKS-061	42	
1	3	3,8	3													●		●									GKS-080	43	
1	5,5	7,5	3	●																							GKS-081	44	
1,27	2,2	2,8	3													●		●									GKS-069	45	
1,27	1	1,2	3													●		●									GKS-079	46	
1,27	5,5	7,5	3																●								GKS-181	47	
<b>Metric Standard Probes (≥ 2,54 mm)</b>																													
2,54				●	●																						KS-112	50	
2,54	4	5,3/8	5 – 8									●	●					●									GKS-112	51	
2,54	4	5	5 – 8	●	●							●	●					●									GKS-912	52	
2,54	6,4	8	5 – 8	●	●							●	●					●							●		GKS-422	53	
2,54	8	9,8	5 – 8	●	●							●	●					●									GKS-412	54	
2,54	8	10	5 – 8	●	●	●						●	●					●		●							GKS-204/204M	55	
2,54	4,8	6,5	5 – 8																						●		GKS-102	56	
2,54	5,6	7	5 – 15									●	●												●		GKS-502	57	
4	4	5,3	5 – 8															●									GKS-113	58	
4	2,8	3,5	5 – 8				●	●								●		●									GKS-913	59	
4	4,8	6	5 – 8				●	●										●									GKS-103/103M	60	
4	5,6	7	5 – 15				●	●				●	●												●		GKS-503/503M	61	
6,5	4	5	5 – 20					●				●	●					●									GKS-364	62	
6,5	3,2	4	5 – 8					●				●	●					●									GKS-365	63	
6,5	8	10	5 – 8					●				●	●					●									GKS-366	63	
<b>Solderable Probes</b>																													
1,91	3,2	4	5 – 8				●	●				●						●									GKS-941	66	
2,54	1,4	1,7	5 – 8				●	●										●									GKS-064	66	
2,54	3	5	5 – 8				●	●																			GKS-986	66	
<b>Short-stroke Probes</b>																													
3	1	1,2	5 – 8				●	●								●		●									GKS-967/967 M	68	
2,54	1	1,2	5					●								●		●									GKS-761 M	69	
3	2,8	3,3	5 – 8					●								●		●									GKS-970	69	
1,91	1	1,3	2					●								●		●									GKS-961	69	

Grid in mm (Mil)	Recommended Stroke in mm	Max. Stroke in mm	Current Rating in A	ICT / FCT	Combined ICT-/FCT-Test	Cable Harness Probes	Solderable Probes	Battery Probes	Micro-Contacting	RF-Applications (HFS)	High-Current Applications	High Temperature Range	Component Presence Check	Individually controllable Probes	Interface Probes	Low Installation Height	High Installation Height	Short-stroke Probes	Long-stroke Probes	Through (continuous) Plunger	Non-Rotating Probes	Rotating Probes	High Spring Forces	Stroke-measurement Probes	Series	Page	
<b>Flying Probes</b>																											
2,54	4	5,3/8	5-8																						GKS-112 MD	72	
<b>Rotating Probes</b>																											
1,27	4,3	6,35	2-3	•																					DKS-050	74	
1,91	4,3	6,35	3-4	•																					DKS-075	74	
2,54	4,3	6,35	5-8	•																					DKS-100	74	
2,54	4,8	6	5-8																			•			GKS-725	75	
4,5	4	5	5-8																	•		•			GKS-713	76	
<b>Switching Probes</b>																											
2,54	5	6	3										•													SKS-100	78
2,54	4	5	3										•													SKS-215	79
3,5	4	5,2	5										•										•			SKS-415	80
3,5	6,4	8	5										•						•							SKS-425	81
7,5	11,2	14	5										•													SKS-419	82
10	12,8	16	5										•										•			SKS-429	82
<b>Pneumatic Test Probes</b>																											
3,5	6	10	2											•		•										PKS-355 M	84
4,5	12	20	2-3											•		•										PKS-388 M	85
3,5	6	10	2										•			•										PSK-350 M	86
1,91	6	10	2											•		•										PKS-171	87
2,54	6	10	2											•		•										PKS-200	88
2,54	6	10	3											•		•										PKS-220	89
3,5	12	20	3/10								•			•		•			•							PKS-299	90
3,5	6	10	3/10								•			•		•										PKS-300	91
4,5	12	20	3/10								•			•		•			•							PKS-399	92
4,5	6	10	3/10								•			•		•										PKS-420	93
-	-	-	-																							PKS Accessories	94/95
<b>Radio-frequency Test Probes / Dipole Test Probes</b>																											
2,54	5,5	7,5	3							•																HFS	98/99
2,54	5,5	7,5	3							•																HFS-010	100
4,5	4	5	3							•																HFS-110	101
<b>High-current Test Probes</b>																											
2,54	4	5,3/8	16								•	•														HSS-118	104
4	4	5,3	24								•	•														HSS-120	105
4	2,8	3,5	24			•	•	•			•	•				•		•								HSS-520/520M	106
5,08	4,4	5,5	50								•	•											•			HSS-150	107
12	7	9,5	25								•	•												•		HSS-2259	108
16	7	10,5	35								•	•													•	HSS-2513	108
20	7	12	100								•	•													•	HSS-2516	108
30	7	11	200								•	•													•	HSS-2526	108
35	7	11	400								•	•													•	HSS-2532	108
<b>Interfaces / Customizing</b>																											
2,54	2,6	3,1	5												•	•										GKS-945	110
2,54	3,2	3,9	5												•	•										GKS-946	110
2,54	3,6	4,3	5												•	•										GKS-938	110
2,54	3	4	5												•	•										GKS-100 357 150 ...	110
2,54	4,3	6,35	5												•	•										GKS-100 307 150 ...	110
5,08	4,3	6,35	5												•	•										GKS-100 306 229 ...	110
															•	•										KT-...	111
5	5	6	5																							GKS-925 TJA	112
1,91	4,3	6,35																						•		HMS-075	112
2,54	4,3	6,35																						•		HMS-100	112
2,54	6,4	8																						•		HMS-422	112
4,5	9,2	11,5															•		•					•		GKS-416	113
5	4,8	6,5																						•		GKS-102	113
4,5	11,2	14	5-15														•		•	•				•		GKS-504	113
8	9,6	11,2	5-8														•		•					•		GKS-414	113
																										Fixtures Accessories	114-116
<b>Insertion and Extraction Tools</b>																											
																										SW/ZW/AW	118



# Complete Solutions from one Supplier

## Test Probes



**Test Probes:** The high-precision Test Probes are the heart of every test. With more than 20,000 variants in more than 400 series INGUN provides the largest assortment worldwide; from a standard Test Probe to an individually manufactured Test Probe.

The Radio-Frequency Probes are listed in a separate Catalog. There you can find directly the suitable RF-Probes via a Jack/Plug Register.

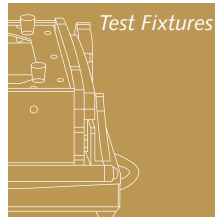

## Test Fixtures

**Test Fixtures:** Mechanical, pneumatic and vacuum- operated Test Fixtures as well as special customized contacting units are developed and manufactured by INGUN for all common Test Systems. The strength lies in special Test Fixture design and build, because over 40 years of experience provides sophisticated and extraordinary solutions.

INGUN plays a special role in regard to the verify quality of Test Fixtures. These can be checked at various manufacturing stages with the use of an optical measuring machine. A unique service!

## Content

Contents Test Probes	inside cover
Team	Page 4+5
Technical Information	Page 6–13
Overview of Tip-Styles	Page 14+15
Special Applications	Page 16

### Test Probes

Register Overview – Test Probes	Page 17
INGUN Test Probes for reliable contacting of lead-free Surfaces and Solder Materials	Page 18
Datasheets and technical information – Test Probes	Page 19–118

### Test Probes for Cable Harness Testing

Register Overview – Test Probes	Page 119
Contents Cable Test Probes	Page 121
Datasheets and technical information – Test Probes	Page 125–171

Fax Sheet	Page 172
INGUN Test Probes according to Series	Page 173

# INGUN: Quality through Precision

Since 1971 INGUN is the reliable partner for innovative technology in the field of Test Equipment and for well thought-through testing strategies. INGUN offers an extensive range of Test Probes, Test Fixtures and for individual testing tasks and is a globally active company with its headquarters in Konstanz Germany and over 40 Agencies worldwide.

## INGUN Test Probes: This is where Quality Assurance begins

The variety of Test Probes is unique! With more than 20,000 variants in over 400 series, INGUN offers you an unsurpassed choice of Test Probes for every testing task. Spring-loaded, Pneumatic, as a Switching Probe, a High-frequency or a High-current Probe as well as a Rotating or non-rotating Probe – with over 50 different tip-styles.

INGUN supplies Test Probes for SMD-Technology in grids of 25 mil (0.635 mm), 50 mil (1.27 mm), 100 mil (2.54 mm) and up to 250 mil (6.35 mm). And should you not find a suitable Test Probe for your demands, then INGUN will provide you with an individual, special solution.

## Manufacturing in accordance to customer demands

Whether a customized, special solution or in large volume: Test Probes from INGUN are developed and manufactured with a high quality standard. CAD-supported design engineering as well as manual and automated production and assembly ensure precise, rational and efficient manufacturing. The Test Probes are continuously tested under laboratory conditions using computer-controlled fully automatic fatigue-test stations. For best quality and long life.

## Solutions for the Market of tomorrow

More and more sophisticated test requirements and new developments on the market demand from INGUN innovative ideas and the continuous introduction of new products. With its own Innovation Dept., INGUN is always one step ahead of these increasing demands. The experienced engineers develop customer-orientated product concepts, which lead to cost-/performance optimization. With the customer demands from tomorrow in view, visions become reality.

## Quality "Made in Germany"

INGUN sees it as a future obligation to continue to be one of the leading manufacturers of Testing Equipment worldwide, and is certified in accordance to ISO 9001.

ISO 9001



ingun<sup>®</sup>

PRÜFMITTEL



## Your Contact Partner

The competent employees from INGUN are available when a solution to your testing requirements is needed. From the choice of the most suitable Test Probes to the supply of your customized solution and more: INGUN is your competent and flexible partner. Get in contact with us!

Tel. +49 7531 8105-0  
Fax +49 7531 8105-65  
info@ingun.com  
www.ingun.com

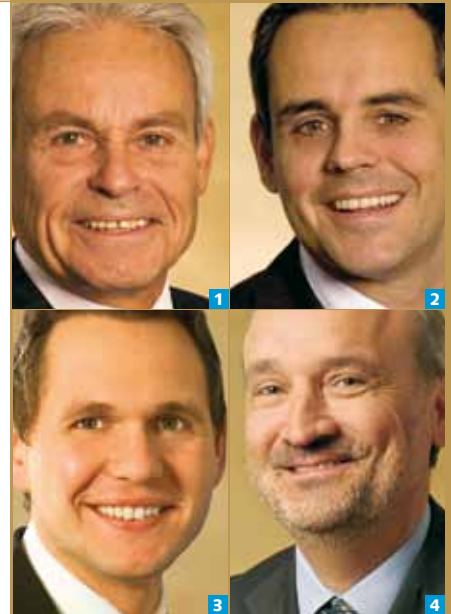

- 1** Supervisory Board  
Wolfgang Karl
- 2** Managing Director  
Armin Karl
- 3** Commercial Director  
Jochen Müller
- 4** Technical Director  
Michael Eisele





5

5 Reception  
Gabriele Seifritz



6

6 Head of Export Sales  
Katharina Hunke



7

7 Head of Sales  
D/CH/Benelux  
Sigfrid Nagel



8

8 Export Manager  
Asia-Pacific  
Marco Bisconti



9

9 Export Manager EMEA  
Joachim Kaebisch



10

10 Export Manager  
Americas  
Basil Ott

11 Order Processing  
Test Probes  
Inge Salewski



11

12 Order Processing  
Test Probes  
Christina Staack



12

13 Order Processing  
Test Probes  
Manuela Martin



13

14 Order Processing  
Test Probes  
Alexandra Muly



14

# Design of INGUN Test Probes

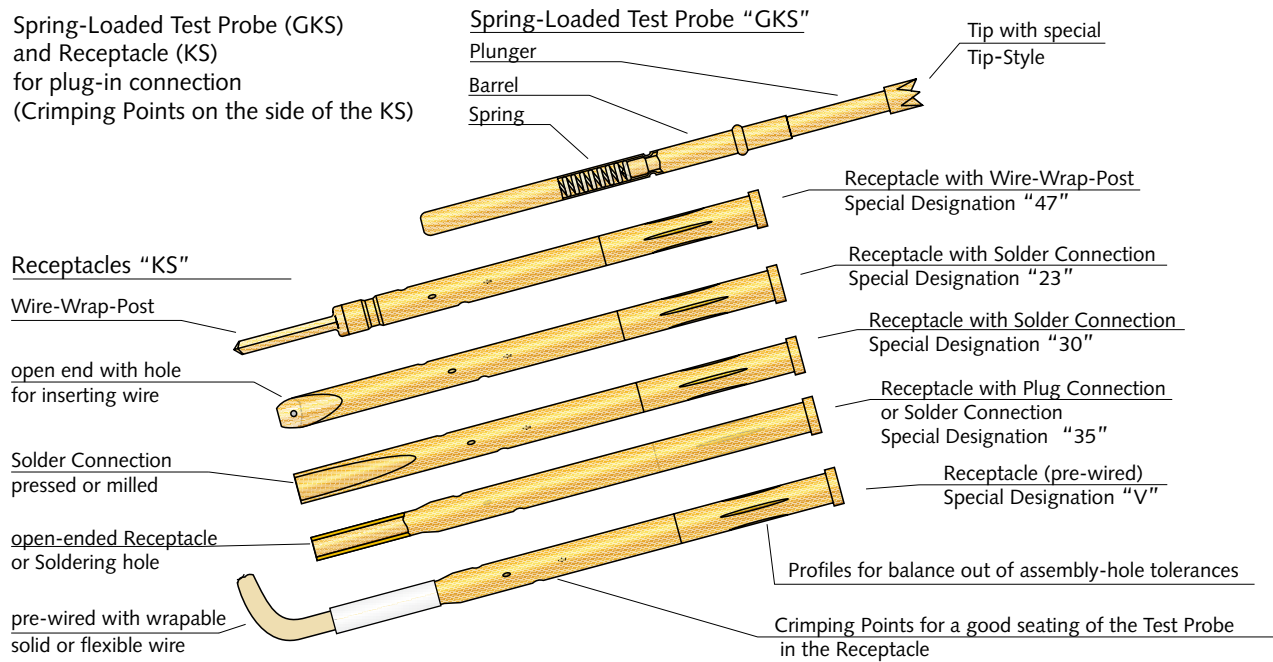

**Spring-loaded Test Probes (GKS)** normally consist of 3 individual components. All components must be manufactured with the type of precision, which is demanded by the micro-electronics industry.

**The Plunger** with the contacting zone is available in a large choice of tip-styles. It must provide the smallest possible contact resistance between the Test Probe and test point, to ensure that measurement results are not distorted. The most common plunger materials are Steel and BeCu-both of which are hardened. For very passive tip-styles brass is also used.

**The Spring** provides the necessary contact pressure, and this even after several hundred thousand strokes (testing cycles). The specified spring-forces are reached with the recommended working stroke and are subject to a tolerance range of +/- 10–15%; this being due to the parameter restrictions when designing and manufacturing springs for such small components.

For easy measurement of the spring forces, common spring-force measuring gauges are used.

**The Barrel** accommodates the plunger and the spring. The actual measurement signal flows via the barrel to the Receptacle. To improve the smooth movement, after gold-plating the barrel is treated with a very thin organic protective layer.

**The Receptacle (KS)** provides easy interchange of the Test Probe during maintenance and servicing of the Test Fixture. The exchange can be carried out fast and without any wiring work. To enable this, crimp points are applied to the side of the Receptacle. Note: the crimp points only function properly when the Receptacle has been inserted in the assembly hole. This means that pre-insertion of the Test Probe in the Receptacle is not possible!

## INGUN-Receptacles

A special feature of the INGUN Receptacles of the newest generation is the so-called "INGUN-Profile". This is a lengthwise crimp (applied either three or four times), which is positioned directly below the collar or press-ring of the Receptacle.

### The Profile plays the following roles:

- Equalises differences of the drilled hole diameter
- Leads to a smooth insertion force of the Receptacle in the assembly hole
- Allows self-registration of the Receptacle and also prevents slanting
- Guides and centres the Test Probe
- Reduces the influence of the assembly hole on the securing force of the Test Probe

Normally, the "INGUN-Profile" is combined with the "INGUN Spiral Crimp". This is a "4-Point Crimp", which is applied to the lower end of the Receptacle in a spiral shape spread out over 360°.

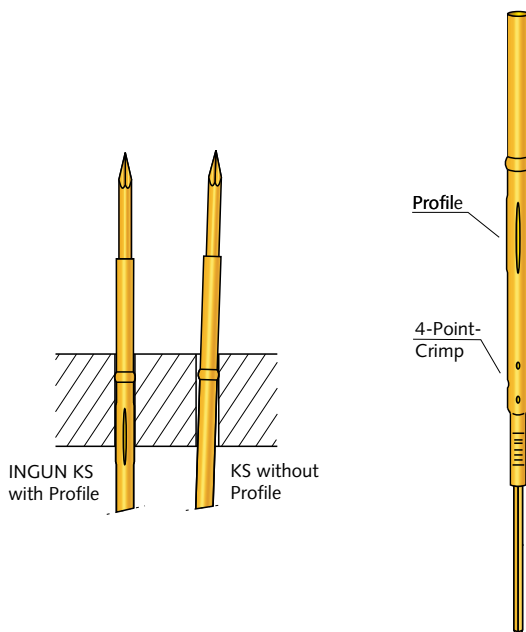

### This type of securing crimp ensures:

- Low and smooth insertion forces
- Smooth extraction forces of the Test Probe
- High flexibility and elasticity of the securing crimp points to increase the number of insertion cycles of the Test Probe

These excellent insertion and securing conditions derive from the fact that the various securing levels are gradually reached and the crimp points are only slightly malleably deformed. Subsequently, the final securing force of the Test Probe is only then achieved when the last crimp point has been reached.

To ensure the resilience of the crimp it is not allowed to solder or coat them with plastic.

## 3D-CAD Models of the Test Probes in Internet

On our Homepage [www.ingun.com](http://www.ingun.com) you can download our CAD-Data of the Test Probes as 3D Models in STEP format, and then open them in your CAD-program. This service offers you the possibility to implement our models in your design work.

The 3D-CAD Models of the Test Probes can be found under "Downloads -> Downloads Test Probes".

# Composition of INGUN Test Probes

## Base Materials

The choice of the base materials is dependent on the demands put on each individual component.

**Brass** is sometimes used for passive tip-styles and for machined barrels. The high percentage of copper makes it an ideal electrical conductor. Brass, however, is too soft for aggressive tip-styles.

**Steel** is used for practically all aggressive tip-styles. It provides a high level of hardness and sharpness of the points and the flanks. This ensures good durability and reliable contacting.

**BeCu (Beryllium-Copper)** provides a good combination and compromise between brass and steel: The high percentage of copper makes it an ideal electrical conductor and the small percentage of Beryllium allows the base material to be hardened (up to 435 HV). This then ensures good durability and optimizes the aggressiveness of the plunger tip.

**New-Silver (NiAg)** and Bronze are mainly used for Receptacles and the Barrels of the Test Probes. These materials have a high tensile strength, which is ideal for the long-term life of Test Probes. Furthermore, these materials provide a good elasticity of the crimps on the Receptacles.

**Spring Steel** of the highest possible quality is used for the manufacturing of the springs. For high and low temperature ranges, certain high-alloyed spring steels (i.e. stainless steel) are used.

## Plating Materials

Hard-gold, chem. Nickel and Rhodium are used. The choice of plating materials is made according to functional features.

**Hard-gold:** best chemical resistance, Hardness 150–200 HV. Especially good against oxidation.

**Rhodium:** extremely good resistance to wear, Hardness 600–1000 HV; very brittle. Usage when special demands in regard to durability of the plunger tip are required. Because of the brittleness, this plating material is not suitable for aggressive tip-styles in conjunction with high spring forces.

**Chem. Nickel:** very good chem. resistance, Hardness 400–600 HV. Important because of the true depositing, i.e. without build up on points and edges (so-called “dog-bone” effect). Very suitable as durable layer for plungers. Because of the relatively high ductility. This plating material is ideal for aggressive tip-styles.

**Aurun:** this gold-alloy plating type was developed especially for Test Probes and has a very good chem. resistance. Hardness 300–350 HV. Usage for aggressive tip-styles for testing unwashed PC-Boards.

All plating materials guarantee the best contacting reliability due to the very low specific resistance values.

## EG Environmental Legislations

Numerous European Environmental Legislations have the aim to ensure a high level of protection of human health and the environment. For this reason, the business decisions and actions of INGUN Prüfmittelbau GmbH are always regarded in the interest of these legislations.

For the presently most important European Environmental Legislations, INGUN has prepared official statements, which are always up to date and available on our homepage [www.ingun.com/company](http://www.ingun.com/company)





# General Definitions and Criteria

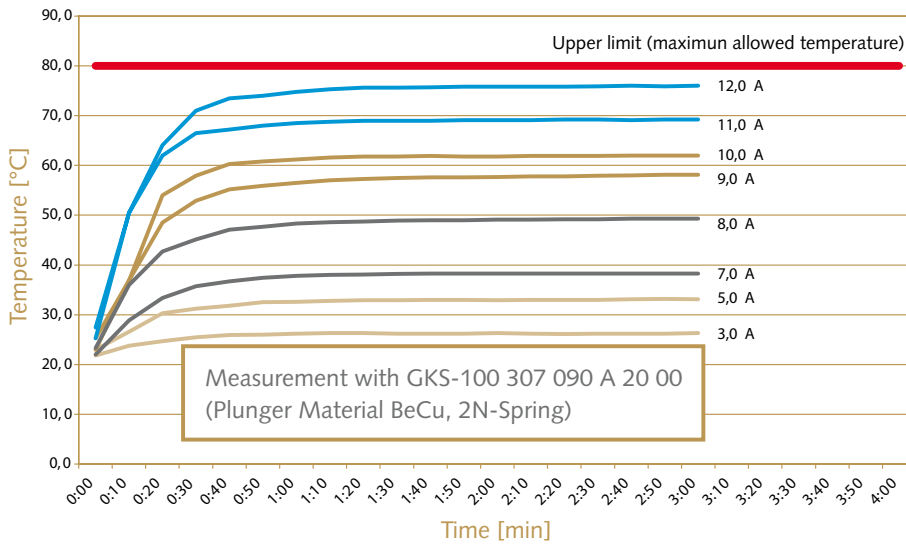

The following diagram shows the evaluation of a Test Probe of the series GKS-100 with a BeCu Plunger and 2,0 N spring-force.

## Current Loading

The transferable permanent current of Test Probes depends on the size of the components, the spring force and the used plunger material. In the case of the plunger material, the following is applicable: BeCu and Brass Plungers transfer higher currents as Steel Plungers. The allowed rated currents are printed on each individual data sheet. These values are valid at room temperature and for direct current – and from the stated “Standard” spring – force at working stroke. In the case of alternating currents, the value must be reduced by the factor  $\frac{1}{\sqrt{2}}$ .

To avoid damages to the test probes e.g. component contact under load (attached current/voltage) is not allowed.

The maximum allowed current loading (see “Electrical Data” of each product) was derived for each series in extensive load tests. The test set-up called for the various Test Probe series and spring forces to be loaded with a certain current, during which the temperature change of the Test Probe was measured. The increase of the current was applied in steps of 1–2 Amps, but only as long as no temperature increase was registered.

# General Definitions and Criteria

## Drilling Tolerances

When machining the assembly holes in the Probe-Plate (KTP) it is necessary to differ between the diameter of the drilled hole and the diameter of the actual drill. The sizes in the catalog are related to the diameter of the drilled hole. This size can be measured with a common plug gauge.

Depending on the material and the thickness of the probe-plate, the diameter of the drill should be chosen 0.01–0.03 mm larger. At the same time, other parameters such as, e.g. drill speed and feed etc. also play an important role. Note: it is vital to carry out drilling tests beforehand.

The materials FR4/G10 (glass-fibre enforced synthetic material) and CEM1/Trolitax (hard-paper impregnated with resin) have proven to be especially suitable as probe-plate materials. Especially in the case of small assembly hole diameters there is an acute danger that the drilled holes become slanted, which leads to the Receptacles and the Test Probes also being slanted when inserted and subsequently results in a negative influence of the contacting accuracy. In this case, INGUN recommends that the assembly holes in probe-plates thicker than > 10 mm are counter-bored from the underside. Furthermore, drilling the holes in steps is also advisable.

## Life-expectancy of INGUN Test Probes

To determine the life-expectancy of Test Probes INGUN continuously carries out fatigue tests under laboratory conditions using computer-controlled fully automatic fatigue test stations.

Here the behaviour of important parameters such as contact resistance or the spring force during the life of a Test Probe can be observed and defined. The resulting knowledge is taken into consideration in the development. This guarantees state of the art high-quality standards.

The life-expectancy of Test Probes is a function of various parameters such as spring force, axial loading, current loading as well as external influences such as contamination and temperature.

INGUN has avoided printing out here any diagrams and tables of tests, which were carried out under laboratory conditions, because such results would only give the user a false impression. This being because the above stated influences are non-calculable factors, which can have a decisive influence on the life-expectancy of a Test Probe. Under laboratory conditions it is possible that some Test Probes series will do well over 1 million cycles, but the actual period of usage could well be much less because, for example, the strong general wear of the Test Probe leads especially to wear of the contacting zone-resulting in a drastic increase of the contact resistance values.

## Application Temperature Range

INGUN Test Probes can be used without any problems between -40°C and +80°C. For lower and higher temperature ranges there are many special solutions available (see List of Contents: "High Temperature" or "Application Temperature Range" by the various Probe series).

These Test Probes are normally recognisable with the special designation "C" (-100°C to +200°C). Certain high-alloyed (stainless steel) spring steel types are used, which however have the disadvantage that the transition resistance is up to factor 10 higher as by standard Test Probes. Apart from this the constancy of the resistance is affected (i.e. fluctuations are possible).

In the case of these special solutions there is also the danger that greater temperature fluctuations as well as operation in temperatures other than normal can lead to premature breakdown or a reduction of the life-expectancy of the Test Probe.

### Wobble and Minimum Test Point Size

Due to the necessary play between the Plunger and the Barrel of a Test Probe, the tip can be deflected out of the ideal (i.e. vertical) position. This deflection, the so-called "wobble", was measured on INGUN Test Probes using a state-of-the-art optical measuring machine. This machine can, on request, also be used to verify customized Test Fixtures. To define the minimum test point size, the various tolerances of the Test Fixture were also taken into consideration.

Basically, the statement can be made that no direct dependency between the wobble and the contacting accuracy of a Test Probe exists. Important is especially the position of the probe tip at the time of actual contacting. For the subsequent stroke it is even often an advantage when a greater wobble exists, because this then helps to reduce the wear when the plunger is pressed down into the barrel. Furthermore, the tendency to bend the Test Probe is reduced and thus the life-expectancy prolonged.

The following diagram shows the deflection of the Plunger from the ideal position (i.e. the centre of the assembly hole) of various Test Probes. The experimental set-up was made with a standard INGUN probe plate, and the Test Probes were inserted in Receptacles. The row of experimental tests was carried out a number of times. Between each measurement the Test Probes were activated a few times.

The result of the investigation offers no information about other factors, which must also be taken into consideration, i.e. the tolerances of the PC-Board and of the Test Fixture assembly as well as the uncertainty and faults, which can be incurred during insertion and removal of Receptacles and Test Probes. Therefore, INGUN recommends the usage of a guide plate (especially in the case of critical applications, i.e. Test Point Size < 0,8 mm) with which the plunger tips are guided. Then, the majority of the tolerances can be ignored.

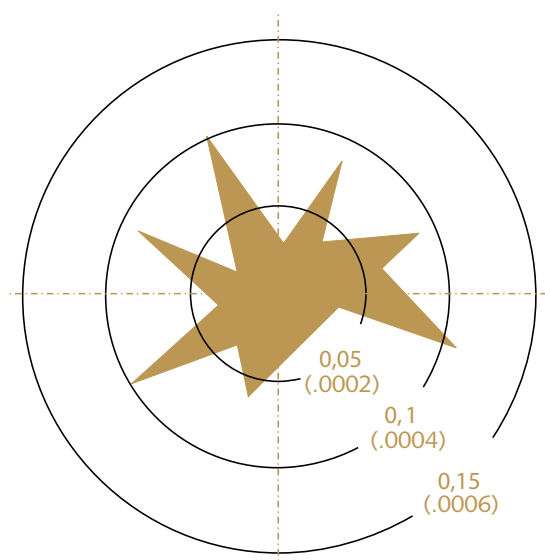

[Measurements in mm (inches)]

# General Definitions and Criteria

## Recommended Working Stroke and Maximum Stroke

When choosing a Test Probe for a certain application, then not only the installation height and the type of tip-style are important but also the required stroke of the Test Probe.

In the home position, the plunger of the Test Probe is not activated but still has a certain pre-load; the assembly beading then acts as a stop to prevent the plunger coming out of the barrel. The rated spring force is reached when the plunger is activated to the working stroke position. Depending on the series, this lies between 66% and 80% of the maximum stroke.

The following example shows the spring force/stroke movement for the various spring forces offered in the series GKS-100:

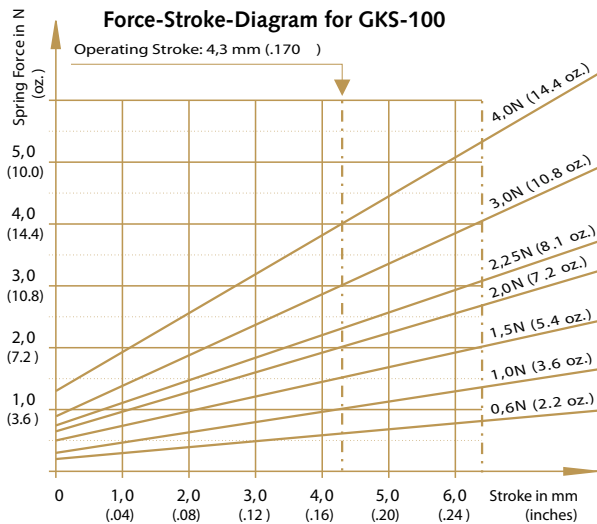
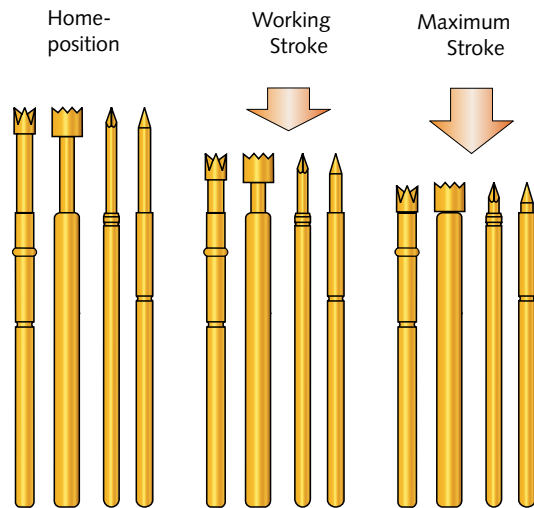

Dependant on whether test pads or component pins are contacted, then the Test Probes make different strokes. In critical cases we recommend that the different installation heights are balanced out. Practically all series offer this possibility, either with the choice of different collar heights (available both by the Test Probes as well as by Receptacles) or with the choice of longer plungers (i.e. L-versions for series GKS-050, 075 and 100).

When customizing a Test Fixture or any other type of Testing Equipment, it is important that the recommended working stroke is strived for. When the maximum stroke is exceeded, then there is the danger that the PC-Board/UUT or the testing equipment (i.e. Test Fixture, Test Probes) are damaged or destroyed.

### Collar Height and Installation Height

The Installation Height is the distance between the tip of the plunger of the non-activated Test Probe and the surface of the Probe-Plate. To regulate the Installation Height the Test Probes are normally available with various different Collar Heights. Apart from this, in the case of certain series Spacers are available, which offer further flexibility of the Installation Height. Test Probes, which have the end designation "00" have no collar on the barrel. In the case of these Test Probes, the Installation Height is determined by the Receptacle.

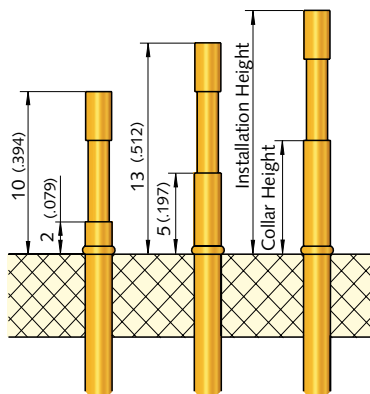

### INGUN Part Number

The logical constellation of the INGUN Part No. allows clear identification and recognition of the Test Probes. The individual numbers define the Series, Material, Tip-Style and Diameter, Spring Force and Assembly Conditions (i.e. grid etc.). Within the series, the various combination possibilities are described on each data sheet. After choosing the individual components, the Order No. of the Test Probe can be derived using the following system:

GKS	-	100	2	91	090	A	20	00	C
1		2	3	4	5	6	7	8	9

1	Type of Product	DKS	Rotating Test Probe
		DS	Spacer
		E	e-type Probe
		GKS	Standard Test Probe
		HFS	High-frequency Probe
		HSS	High-current Probe
		HMS	Stroke-measuring Probe
		KS	Receptacle
		KT	Contact Terminal
		PKS	Pneumatic Probe
		PSK	Pneumatic Switching Probe
		SE	Plug
		SKS	Switching Probe
		T	Screw-in Step Probe
		VF	Push-back Probe
		VS	Plug
2	Series		
3	Tip Material	0 =	Nylon (e.g. Delrin)
		1 =	Brass
		2 =	Steel
		3 =	BeCu (Beryllium-Copper)
4	Tip-Style		see "Overview Tip-Styles"
5	Tip Diameter		in mm/100 (e.g. 090 = 0.9mm)
6	Tip Plating	A =	Gold
		G =	Aurun
		N =	Nickel
		R =	Rhodium
		S =	Silver
7	Spring Force		in N (Newton)/10 (e.g. 20 = 2.0N)
8	Collar Height		Collar Height of the Barrel in mm 00 = no Collar
9	Special Designation		(e.g. "C" = heat-proof)

# Overview of Tip Styles

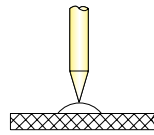

**Tip Style 01 (30° tip angle)**  
Commonly used, less aggressive tip for Testpads.

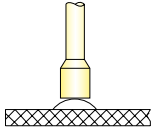

**Tip Style 02 (flat)**  
Very passive tip, for contacting clean test points such as Testpads which shouldn't be punctured, as well as connector and plug-in card terminals.

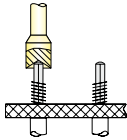

**Tip Style 03 (Inverse Cone)**  
Common tip for contacting connector pins and wire-wrap posts.

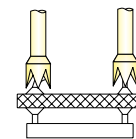

**Tip Style 04 (Standard 4-point Crown)**  
One of the most common tips for contacting component pins. Not to be recommended for unwashed PC-Boards, because tendency to contamination and clogging of solder-resin in the throat of the crown.

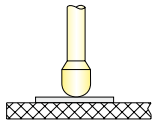

**Tip Style 05 (flat or bullet-nosed)**  
Most popular passive Tip Style, for contacting clean test points such as Testpads and even tracks.

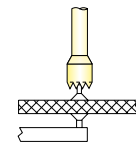

**Tip Style 06 (serrated)**  
Universal Tip Style for contacting practically all types of pins (e.g. connectors, WW-posts, component pins etc.).

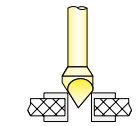

**Tip Style 07 (90° tri-hedral or pyramid)**  
Most common Tip Style for contacting both plated open-vias and Testpads. Replaces more and more the Tip Style 01. Also used as interface probe tip in conjunction with an INGUN contact terminal (see page 70) for the INGUN VIN Test Fixtures.

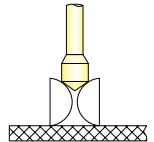

**Tip Style 08 (90° conical tip)**  
Also used for contacting plated open-vias, especially when damage to the contacting area must be avoided. Also suitable for contacting mullet-point and plug-in connectors together with low spring-forces.

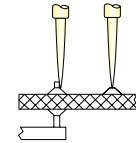

**Tip Style 09 (flexi-needle)**  
Universal Tip Style for contacting practically all types of test points except plated open vias. Offers a high level of stability combined with flexibility. Often chosen for contaminated, unwashed PC Boards.

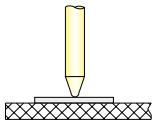

**Tip Style 13 (30° tip with bullet-nose)**  
Rather passive tip, commonly used for Testpads where puncturing must be avoided. Also suitable for contacting tracks.

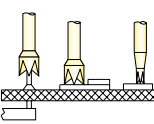

**Tip Style 14 (self-cleaning 4-point Crown)**  
The most commonly used tip for contacting component pins. The modified 04 crown design prevents clogging of solder-resin in the throat of the crown.

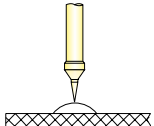

**Tip Style 15 (22° pressed-in HSS-tip)**  
Offers a high level of stability and aggressiveness for special contacting demands as far as resistance to wear is concerned.

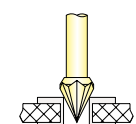

**Tip Style 17 (90° hexagonal)**  
The six knife-shaped edges centre the tip when contacting plated open-vias. Similar characteristics as Tip Style 07, but much more aggressive.

(aggressive inverse cone, self-cleaning) **Tip Style 19**  
 With this modified design of the tip-style 03 an aggressive contacting contour in the centre is created by applying cross grooves. Subsequently, a maximum of contacting reliability is achieved when contacting component pins and wire-wrap posts.



(6-point Crown with higher set middle point) **Tip Style 24**  
 Universal usage for practically all test points.

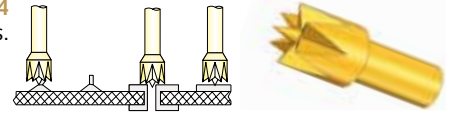

(self-cleaning 3-point Crown) **Tip Style 33**  
 A modified version of the 4-point self-cleaning Crown (Tip Style 14), manufactured with ground flanks and therefore very aggressive. Can be used both for component pins as well as Testpads.



(Passive Dagger, 150° tip angle) **Tip Style 38**  
 Comparable with Tip Styles 97 and 98, however with even flatter tip angle, for contacting Open Vias and Pads.



(aggressive tri-hedral tip) **Tip Style 77**  
 Universal usage for plated open-vias. Similar characteristics as Tip Style 91 (dagger), however with three contacting edges instead of two. More stable tip, but therefore less aggressive.



(Starshaped tip for contacting Bead Probes) **Tip Style 79**  
 Multiblade tip style with self cleaning function.



(8-point Crown) **Tip Style 88**  
 Self-cleaning Crown with good centring features. Suitable for contaminated component pins.



(self-cleaning 3-point Crown) **Tip Style 89**  
 Recommended for unwashed PC Boards. The special shape of the ground steel tips ensures that any contaminating particles are "pushed" back from the contacting zone around the points.



(Dagger) **Tip Style 91**  
 Universal usage, and by far the most popular Tip Style, for not only plated open-vias but also Testpads. Very aggressive, ground flanks.



(Tri-needle, 22° pressed-in HSS-tip) **Tip Style 93**  
 Due to the three very aggressive HSS tips, ideal for contacting unwashed PC Boards and other specific testing demand.



(Passive Dagger) **Tip Style 97**  
 A modified version of the standard dagger (No. 91), also for universal usage. Designed for plated open-vias which have been closed with sealing lacquer.



(passive Dagger, 90° tip angle) **Tip Style 98**  
 Comparable with Tip Style 97, for contacting Open Vias, which are closed with sealing lacquer.



(serrated, with higher-set outer nylon ring) **Tip Style 006**  
 Standard serrated tip with higher-set outer nylon ring, designed for component presence-check. The designation "0" is for nylon material, the designation 06 for the inner Tip Style.





# INGUN Test Probes for Special Applications



## As a Test Probe

Test Probes from INGUN are used to test PC-Boards, among other in the Automotive Industry, Telecommunications or Medicine Technology. They are applied, wherever a highest level of safety and reliability of the end-product is required.

## As a component in units

Numerous interesting new solutions and impulses come from the company INGUN in regard to using the advantages of Test Probes also in less-common application areas. Test Probes are used not only as testing equipment but also as components in units; e. g. to provide the necessary reception in mobile telephones, to ensure the contact to batteries in charging stations, as part of a remote control and also used in many other applications.

For example: in the fields of mechanical engineering, telecommunications, vehicle manufacturing and medical technology the high precision of Test Probes and their reliability and long-lastingness are valued.

Our own design dept. works constantly on the application of Test Probes over and above the usual testing tasks. Furthermore, our team of engineers and technicians develop special, individual solutions for specific requirements. Challenge INGUN and ask for the solution to your testing requirements!



# Test Probes

e-type® Probes

---

In-Circuit / Functional Test  
(ICT/FCT)

---

Bead Probes

---

Fine Pitch ( $\leq 1,27$  mm)

---

Metric Standard Probes  
( $\geq 2,54$  mm)

---

Solderable Probes

---

Short-stroke Probes/  
Charging Probes

---

Flying Probes

---

Rotating Probes

---

Switching Probes

---

Pneumatic Test Probes/  
Switching Probes

---

Radio-frequency Test Probes /  
Dipole Test Probes

---

High-current Test Probes

---

Interfaces / Customizing

---

Insertion and Extraction Tools

---

Cable Harness Test Probes

# INGUN Test Probes for reliable contacting of lead-free Surfaces and Solder Materials

Long before the introduction of "lead-free" laws and regulations, INGUN put special emphasis on reliable contacting of lead-free soldered PC-Boards. Close cooperation with our global customers and the resulting production-orientated internal test-runs allows us to promptly use information from diverse contacting applications and areas to constantly further develop our Test Probes in regard to their different types of plating and tip-styles. In addition to the proven and tested aggressive tip-styles "09" (Flexi-needle) and "91" (Dagger) a number of new aggressive tip-styles with flatter tip-angles such as e.g. the tip-styles "38", "97" and "98" have been developed. In conjunction with the right spring-force, these tip-styles enable reliable contacting of the mostly rather thin lead-free surfaces such as e.g. Chem. Sn, Chem. NiAu or OSP – and this despite their high level of hardness and without the danger of short-circuits due to puncturing of the layers of the PC-Board.

For the normally harder and more abrasive lead-free solder materials, which, depending on the application, can also be coated with flux-deposits, making them additionally difficult to penetrate, INGUN now offers the renowned e-type® – High Energy Probes with numerous new series and tip-style variants (see pages 19–21).

## Tip-style 38: Contacting of "lead-free" Vias

Due to the changed wetting behaviour of lead-free solder materials then flux-deposits can get into the holes of vias. This problem can be counteracted with new tip geometries such as the tip-style "38".

You can find more information on this subject under [www.ingun.com](http://www.ingun.com) in our Flyer "Contacting of lead-free solder materials and surfaces".

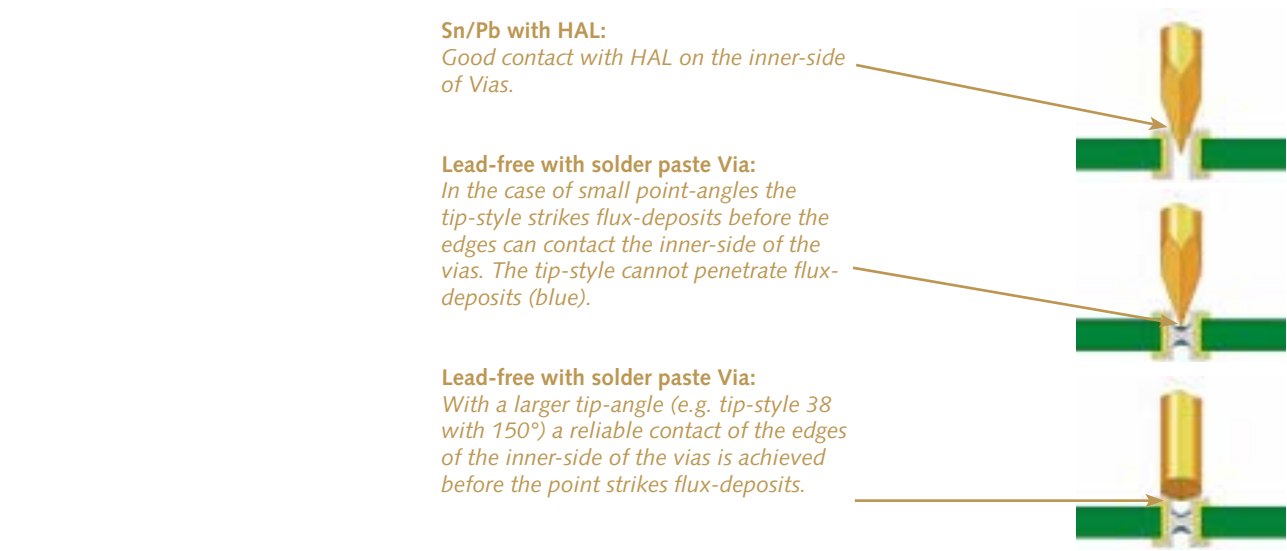

# Achieve the highest contacting reliability by minimized stress of the PC-Board with INGUN *e*-type®

INGUN has developed the e-type®-High Energy Probes for the two decisive factors when contacting PC-Boards: The highest level of contacting reliability without additional stress.

The increased contacting reliability of the e-type® series is based on their special performance with up to 100% higher spring-force during initial contacting of the surface of the PCB. This additionally achieved contacting energy ensures an up to 25% larger contacting area of the Test Probe on the PCB. The additional contacting reliability does not, however, increase the stress of the PC-Board, because in the case of the e-type® principle only the pre-load of the spring is increased and the spring-force at working stroke remains the same.

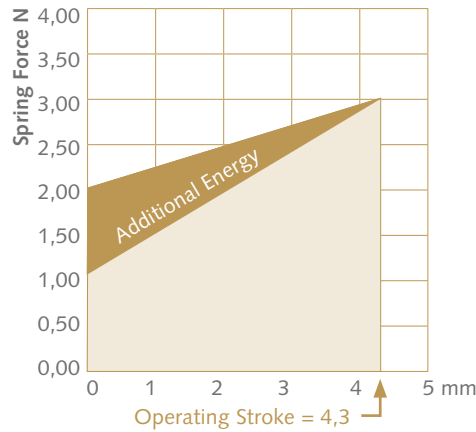

### e-type®-High Energy Probe:

- Available in all common grids: 50, 75, 100 mil
- **NEW** 100% compatible to the standard series GKS-050/075/100/422
- **NEW** Maximum stroke is the same as by standard series, i.e. 6.4mm
- **NEW** Numerous new e-type® tip-styles

Production tests on customer sites confirm the effectiveness.

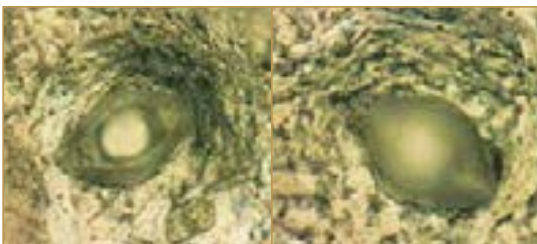

Contacting with Standard Probe (left) and with e-type®-High Energy Probe (right).

You can find more information about e-type® on our homepage [www.ingun.com](http://www.ingun.com)

## e-type®

E-050 <b>NEW</b>	20
E-075 <b>NEW</b>	20
E-100 <b>NEW</b>	21
E-422 <b>NEW</b>	21

# e-type<sup>®</sup> E-050 / E-075 NEW

ICT-/FCT Test Probe for difficult contacting demands

Grid:

1,27 / 1,91 mm

50 / 75 Mil

Installation Height: 16,0 mm (.630) / variable

Recommended Stroke: 4,3 mm (.169)

## Mounting and Functional Dimensions

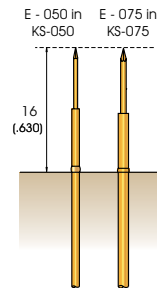
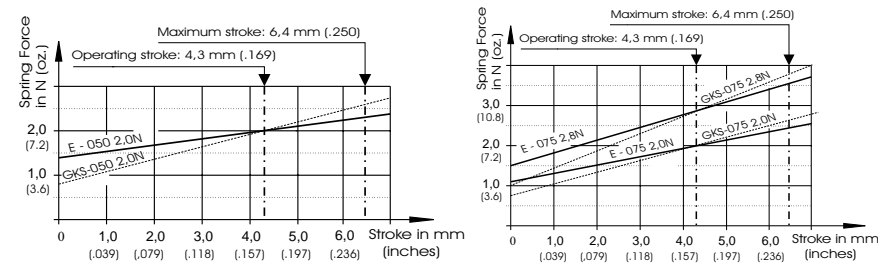
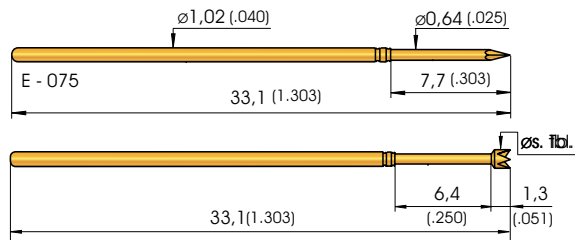
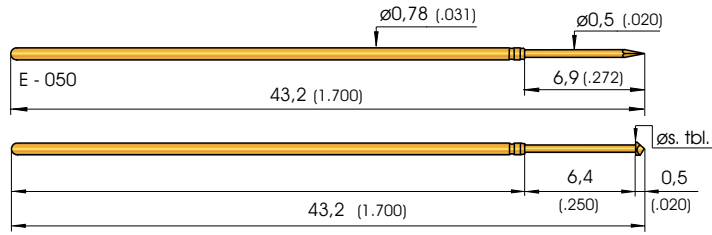

Collar Height and Installation Height, Receptacles, Electrical Data, Mounting Hole Size and Materials:  
see compatible Standard Probe series GKS-050/075

e-type	compatible Probe	Page
E-050	GKS-050	25
E-075	GKS-075	26 / 27

**Mechanical Data**  
**Working Stroke:** 4,3 mm (.169)  
**Maximum Stroke:** 6,4 mm (.250)

### Spring Forces at Working Stroke

Series	Designation	Pre-Load	Force at Work. Stroke
E-050	20	1,4 N (5.1oz)	2,0 N (7.2 oz)
E-075	20	1,2 N (4.3oz)	2,0 N (7.2 oz)
E-075	28	1,6 N (5,8oz)	2,8 N (10.1 oz)

## Available Tip Styles E-050

Material	Tip Style	Plating	Further Versions	
			∅	∅ (inch)
2 01		A		
3 07		A	0,90	A
2 14		A		
2 38		A		
2 77		A		
2 91		A		
2 97		A		

## Available Tip Styles E-075

Material	Tip Style	Plating	Further Versions	
			∅	∅ (inch)
2 01		A		
2 07		A	1,20	(.047)
2 09		A		
2 14		A	1,00	(.039)
2 24 *		A		
2 38		A		
2 77		A		
2 91		A		
2 97		A		
2 98		A		

\* higher middle tip plus 0,2 mm

## Ordering Example

Series	Tip Material 2 = Steel 3 = BeCu	Tip Style	Tip Diameter (1/100 mm)	Plating A = Gold	Spring Force (dN)	Collar Height (mm)
--------	---------------------------------------	-----------	----------------------------	---------------------	----------------------	-----------------------

Test Probes:

E	050	2	91	050	A	20	00
E	075	2	91	064	A	20	00

Grid:  
≥ 2,54 mm  
≥ 100 Mil

Installation Height: 16,0 mm (.630) / variable

Recommended Stroke: 4,3 mm (.169) bzw. 6,4 mm (.252)

### Mounting and Functional Dimensions

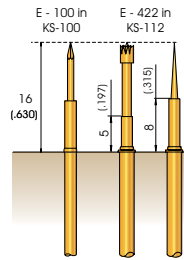
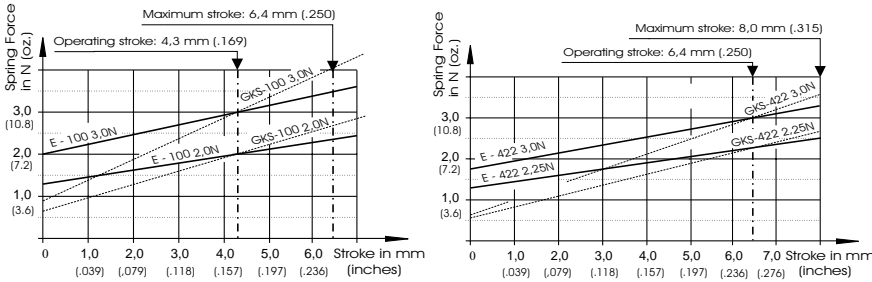
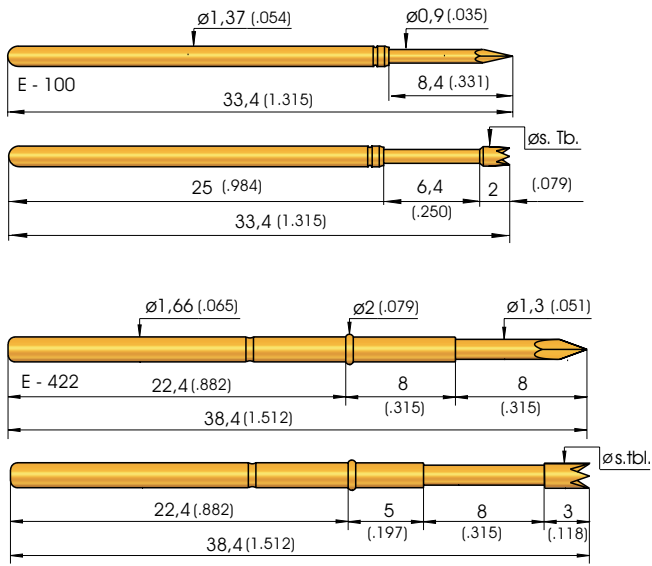

Collar Height and Installation Height, Receptacles, Electrical Data, Mounting Hole Size and Materials:  
see compatible Standard Probe series GKS-100/422

e-type	compatible Probe	Page
E-100	GKS-100	28 / 29
E-422	GKS-422	53

Mechanical Data	E-100
Working Stroke:	4,3 mm (.169)
Maximum Stroke:	6,4 mm (.250)
Mechanical Data	E-422
Working Stroke:	6,4 mm (.250)
Maximum Stroke:	8,0 mm (.315)

### Spring Forces at Working Stroke

Series	Designation	Pre-Load	Force at Work. Stroke
E-100	20	1,3 N (4.7 oz)	2,0 N
E-100	30	2,0 N (7.2oz)	3,0 N
E-422	22	1,3 N (4.7oz)	2,25 N
E-422	30	1,8 N (6.5oz)	3,0 N

### Available Tip Styles E-100

Material	Tip Style	Plating	Further Versions	
			∅	∅ (inch)
2 01		A	∅ 0,90 (.035)	
3 07		A	∅ 0,90 (.035)	
3 07		A	∅ 1,50 (.059)	
2 09		A	∅ 0,60 (.024)	
2 14		A	∅ 0,50 (.020)	
2 14		A	∅ 1,30 (.051)	
2 24*		A	∅ 1,30 (.051)	
2 38		A	∅ 0,90 (.035)	
2 77		A	∅ 0,90 (.035)	
2 91		A	∅ 0,90 (.035)	
2 97		A	∅ 0,90 (.035)	
2 98		A	∅ 0,90 (.035)	

\* higher middle tip plus 0,4 mm

### Available Tip Styles E-422

Material	Tip Style	Plating	Further Versions	
			∅	∅ (inch)
2 01		A	∅ 1,30 (.051)	
3 07		A	∅ 1,30 (.051)	
2 09**		A	∅ 0,80 (.011)	
2 14		A	∅ 1,30 (.051)	2,00 (.079)
2 24***		A	∅ 1,80 (.071)	
2 33		A	∅ 1,30 (.051)	
2 91		A	∅ 1,30 (.051)	

\*\* pressed-in Steel point in Base Plunger made of Brass  
\*\*\* higher middle tip plus 0,5 mm

### Ordering Example

Series	Tip Material	Tip Style	Tip Diameter (1/100 mm)	Plating	Spring Force (dN)	Collar Height
2	3 = BeCu	01	090	A = Gold	30	00 (E-100)
2	2 = Steel	14	050	N = Nickel	30	05 (E-422)
2	2 = Steel	24	130		30	08 (E-422 *)
2	2 = Steel	09	060		30	* with Tip Style „01“ and „09“

Test Probes:

E	100	2	91	000	A	30	00
E	422	2	91	130	A	30	05

e-type<sup>®</sup> Probes  
ICT / FCT  
Bead Probes  
Fine Pitch  
Metric Stand.  
Solderable  
Short-stroke  
Flying Probes  
DKS  
SKS  
PKS / PSK  
RF / Dipole Test Probes  
HSS  
Fixture customizing  
Tools  
Cable Test Probes



# Component Presence-Check

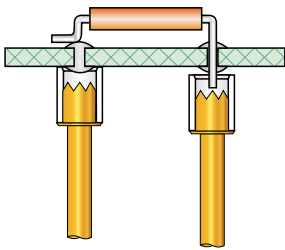

Apart from the possibility to carry out a component check, with a Switching Probe connector pins or component pins can, for example, also be checked by using a Standard Test Probe with an insulated tip ("006"). This type of test, however, is based on the presumption that the component, which must be checked can respond to an electric signal. In the case of the component not being present, then the insulated ring on the tip of the Test Probe rests against the PC-Board and the signal is not transferred.

## In-Circuit / Functional Test (ICT/FCT)

GKS-040	24
GKS-050	25
GKS-015	25
GKS-075	26 + 27
GKS-100 <span style="border: 1px solid black; border-radius: 50%; padding: 2px;">NEW</span>	28 + 29
GKS-035	30
GKS-135	31
GKS-101	32
GKS-001	33
GKS-002	34
GKS-003	35
GKS-004	36
GKS-005	37
KS-040 WL	38
KS-550 WL	38
KS-075 WL	38
KS-100 WL	38
GKS-550	38

Screw-in Test Probes from page 125 on.



# GKS 040

ICT-/FCT Test Probe

**Grid:**

≥ 1,00 mm

≥ 40 Mil

**Installation Height:** 16,0 mm (.630) / variable

**Recommended Stroke:** 4,3 mm (.169)

## Mounting and Functional Dimensions

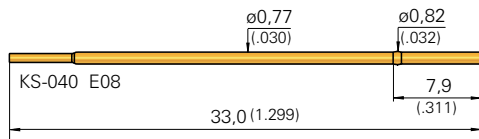
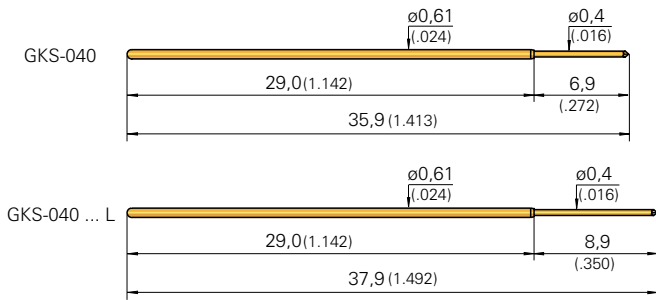

## Available Tip Styles

Material	Tip Style	Plating	Further Versions	
			∅	∅ (inch)
3 04		A	∅ 0,40 (.016)	
3 05		A	∅ 0,40 (.016)	
2 22		A	∅ 0,32 (.013)	
2 38		A	∅ 0,40 (.016)	
2 97		A	∅ 0,40 (.016)	

\* conical down to ∅ 0,40 mm

## Available Tip Styles Special Version GKS-040...L

Material	Tip Style	Plating	Further Versions	
			∅	∅ (inch)
2 97		A	∅ 0,40 (.016)	

Total Length 37,9 mm (1.492), Special Designation "L"

### Collar Height and Installations Height

To adjust the Installation Height, Receptacles with a Press-ring are used. The Receptacles can be inserted up to the Press-ring (i.e. acting as a collar-stop) or with the Press-ring being pressed into the mounting hole.

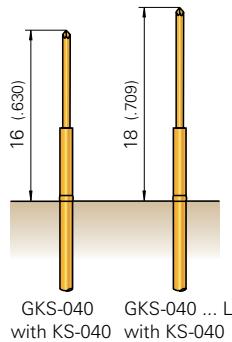

### Mechanical Data

**Working Stroke:** 4,3 mm (.169)  
**Maximum Stroke:** 6,35 mm (.250)  
**Spring Force at Work. Stroke:** 0,8 N (2.9oz)

### Materials

**Plunger:** Steel or BeCu, gold-plated  
**Barrel:** Bronze, gold-plated  
**Spring:** Steel, gold-plated  
**Receptacle:** Nickel-Silver, gold-plated

**Note:**

Receptacles for Wireless Test Fixture see on page 38.

### Elektrical Data

**Current Rating:** 2 A  
**R<sub>i</sub> typical:** < 20 mΩ

### Mounting Hole Size

**in CEM 1:** ∅ 0,79-0,80 mm (.0311-.0315)  
**in FR 4:** ∅ 0,79-0,80 mm (.0311-.0315)

**Note:**

The Receptacle KS-040 is available pre-wired with 1 m Wire AWG 30 (see Ordering Example)

## Ordering Example

Series	Tip Material 2 = Steel 3 = BeCu	Tip Style	Tip Diameter (1/100 mm)	Plating A = Gold	Spring Force (dN)	Collar Height (mm)	Special Designation
Test Probe with total Length 35,9 mm (1.413):	G K S	0 4 0	2 9 7	0 4 0	A	0 8	0 0
Test Probe with total Length 37,9 mm (1.492):	G K S	0 4 0	2 9 7	0 4 0	A	0 8	0 0 L
Receptacles:	K S - 0 4 0 E 0 8		K S - 0 4 0 E 0 8 V - 3 0				



**Grid:**  
 ≥ 1,27 mm  
 ≥ 50 Mil

**Installation Height:** 16,0 mm (.630) / variable  
**Recommended Stroke:** 4,3 mm (.169)

## Mounting and Functional Dimensions

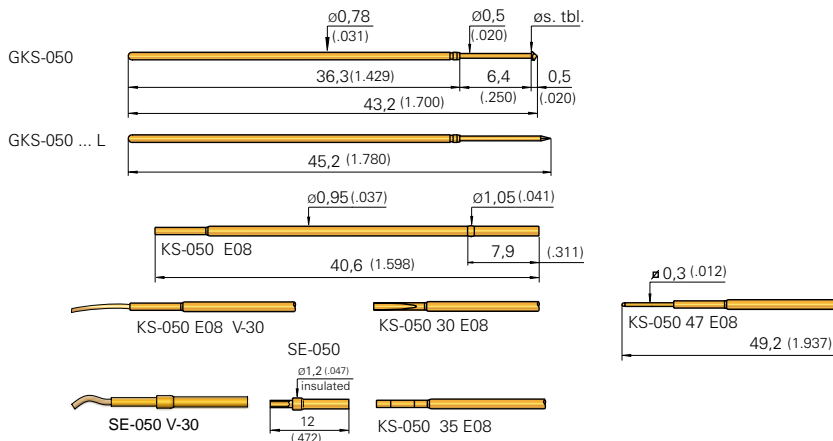

### Long-stroke Test Probe GKS-015

GKS-015 307 050 A xx00  
 GKS-015 291 050 A xx00

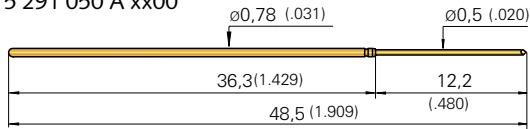

Max. Stroke: 10,0 mm (.394)  
 Work.Stroke: 8,0 mm (.315)

Spring Force at Work. Stroke: 1,5 N (5.4oz)  
 alternative: 1,0 N (3,6oz)

### Collar Height and Installations Height

To adjust the Installation Height, Receptacles with a Press-ring are used. The Receptacles can be inserted up to the Press-ring (i.e. acting as a collar-stop) or with the Press-ring being pressed into the mounting hole.

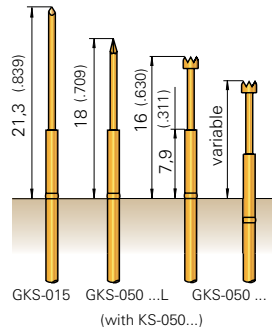

### Mechanical Data

**Working Stroke:** 4,3 mm (.169)  
**Maximum Stroke:** 6,35 mm (.250)  
**Spring Force at Work. Stroke:** 1,5 N (5.4oz)  
**alternative:** 1,0 N (3.6oz); 2,0 N\*\* (7.2oz)  
 \*\* only for GKS-050

### Elektrical Data

**Current Rating:** 2 - 3 A  
**R<sub>i</sub> typical:** < 20 m $\Omega$  (\* < 100 m $\Omega$ )

### Mounting Hole Size

**in CEM 1:**  $\varnothing 0,96 - 0,98$  mm (.0378-.0386)  
**in FR 4:**  $\varnothing 0,97 - 0,99$  mm (.0382-.0390)

### Operating Temperature

**Standard:** -40° up to +80° C  
**\*with Special Designation "C":** -100° up to +200° C (2,0 N)

### Materials

**Plunger:** BeCu or Steel, gold-plated  
**Barrel:** Bronze, gold-plated  
**Spring:** Steel, gold-plated or stainless Steel\* (C)  
**Receptacle:** BeCu, gold-plated

**Note:**  
 Screw-in version see on page 126.

**Tools:**  
 Insertion and Extraction Tools for GKS and KS see Page 118.

## Available Tip Styles

Material	Tip Styles	Plating	Further Versions	
			$\varnothing$	$\varnothing$ (inch)
2 01		A	$\varnothing 0,50$ (.020)	
3 02		A	$\varnothing 0,60$ (.024)	
3 03		A	$\varnothing 0,50$ (.020)	0,90 (.035)
3 05		A	$\varnothing 0,50$ (.020)	
3 06		A	$\varnothing 0,90$ (.035)	
3 07		A	$\varnothing 0,50$ (.020)	0,90 (.035)
2 14		A	$\varnothing 0,50$ (.020)	
2 22*		A	$\varnothing 0,40$ (.016)	
2 31		A	$\varnothing 0,50$ (.020)	
2 38		A	$\varnothing 0,50$ (.020)	
2 77		A	$\varnothing 0,50$ (.020)	
2 91		A	$\varnothing 0,50$ (.020)	
2 97		A	$\varnothing 0,50$ (.020)	

\* conical down to  $\varnothing 0,50$  mm

## Available Tip Styles Special Version GKS-050...L

Material	Tip Style	Plating	Further Versions	
			$\varnothing$	$\varnothing$ (inch)
2 91		A	$\varnothing 0,50$ (.020)	

Total Length 45,2 mm (1.780), Special Designation "L"

**Plug:**  
 The Plugs SE-050 and SE-050 V-30 are to be used with the Receptacle KS 050 35 E08.

**SE-050 V-30 / KS-050 E08 V-30:**  
 The Plug and the Receptacle are pre-wired with 1 m Wire AWG 30. The connection is soldered. A piece of insulation tubing prevents shorts between the Receptacles.

## Ordering Example

	Series	Tip Material 2 = Steel 3 = BeCu	Tip Style	Tip Diameter (1/100 mm)	Plating A = Gold	Spring Force (dN)	Collar Height (mm)	Special Designation ("C" "L" "LC" at Series 050)
Test Probe with total Length 43,2 mm (1.700):	GKS	050	2	91	050	A	10	00
Test Probe with total Length 45,2 mm (1.780):	GKS	050	2	91	050	A	15	00L
Receptacles:	KS-050 E08	KS-050 30 E08	KS-050 35 E08	KS-050 E08 V-30				
Plugs:	SE-050	SE-050 V-30						

e-type® Probes  
 ICT / FCT  
 Bead Probes  
 Fine Pitch  
 Metric Stand.  
 Solderable  
 Short-stroke  
 Flying Probes  
 DKS  
 SKS  
 PKS / PSK  
 RF / Dipole Test Probes  
 HSS  
 Fixture customizing  
 Tools  
 Cable Test Probes

# GKS 075

ICT-/FCT Test Probe

**Grid:**

≥ 1,91 mm

≥ 75 Mil

**Installation Height:** 10,5/13,0/16,0 mm (.413/ .512/ .630)

**Recommended Stroke:** 4,3 mm (.169)

## Mounting and Functional Dimensions

GKS-075

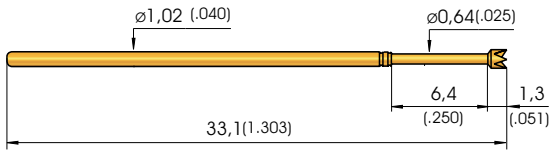

GKS-075 ... L

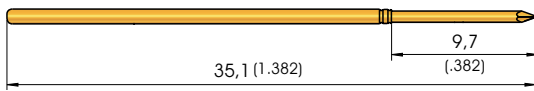
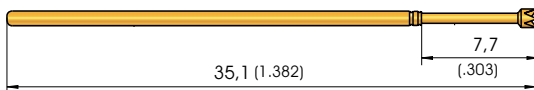

L-Version: by GKS-075 291 064 ... longer Plungers are used, by all other Tip Styles longer Barrels are used.

GKS-075 ... E

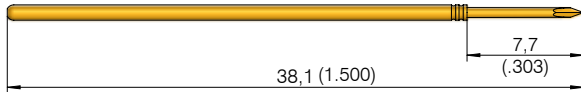

### Mechanical Data

**Working Stroke:** 4,3 mm (.169)

**Maximum Stroke:** 6,35 mm (.250)

**Spring force at Work. Stroke:** 2,0 N (7,2oz)  
alternative (only for GKS-075/075 L):

0,6 N (2.2oz); 1,0 N (3.6oz);

1,5 N (5.4oz); 2,8 N (10.1oz)

### Operating Temperature

**Standard:** -40° up to +80° C

**\*\*with Special Designation "C":** -100° up to +200°C (2,0 N; 2,8 N)

C-Versions only available for GKS-075 with total length 33,1 mm (1.303).

### Materials

**Plunger:** BeCu or Steel, gold-plated

**Barrel:** Nickel-Silver or Bronze, gold-plated

**Spring:** Steel, gold-plated or Stainless Steel\*\* (C)

### Elektrical Data

**Current Rating:** 3 - 4 A

**R<sub>j</sub> typical:** < 20 mΩ (\*\* < 100 mΩ)

### Note:

Screw-in version see on page 128.

## Available Tip Styles

Material	Tip Style	Plating	Further Versions	
			∅	∅ (inch)
0 06*		A	∅ 1,30 (.051)	
2 01		A	∅ 0,64 (.025)	
3 02		A	∅ 0,90 (.035)	
3 03		A	∅ 1,20 (.047)	
2 04		A	∅ 1,15 (.045)	
3 05		A	∅ 0,50 (.020)	
3 05		A	∅ 0,64 (.025)	
3 06		A	∅ 1,00 (.039)	1,20 (.047)
2 07		A	∅ 0,64 (.025)	
NEW 2 07		A	∅ 1,00 (xxx)	1,20 (.047)
2 09		A	∅ 0,64 (.025)	
3 13		A	∅ 0,61 (.024)	
2 14		A	∅ 0,50 (.020)	
2 14		A	∅ 0,64 (.025)	
NEW 2 14		A	∅ 0,80 (.031)	1,00 (.039)
2 17		A	∅ 1,20 (.047)	

\* Tip Height; 2,8 mm (.110)  
Total Length 1,5 mm (.059) longer than Standard

For checking the Stroke of a Test Fixture, we recommend the usage of Stroke Measurement Probes (see page 112).

**Tools:**  
Insertion and Extraction Tools for GKS and KS see Page 118.

## Ordering Example

Series	Tip Material	Tip Style	Tip Diameter (1/100 mm)	Plating	Spring Force (dN)	Collar Height (mm)	Special Designation ("C", "L", "LC", "E")
	0 = Delrin 2 = Steel 3 = BeCu			A = Gold			

Test Probe with total Length 33,1 mm (1.303):

G K S 0 7 5 2 9 1 0 6 4 A 2 0 0 0

Test Probe with total Length 35,1 mm (1.382):

G K S 0 7 5 2 9 1 0 6 4 A 1 5 0 0 L

Test Probe with total Length 38,1 mm (1.500):

G K S 0 7 5 2 9 1 0 6 4 A 2 0 0 0 E

**Grid:**  
 ≥ 1,91 mm  
 ≥ 75 Mil

**Installation Height:** 10,5/13,0/16,0 mm (.413/ .512/ .630)  
**Recommended Stroke:** 4,3 mm (.169)

### Mounting and Functional Dimensions

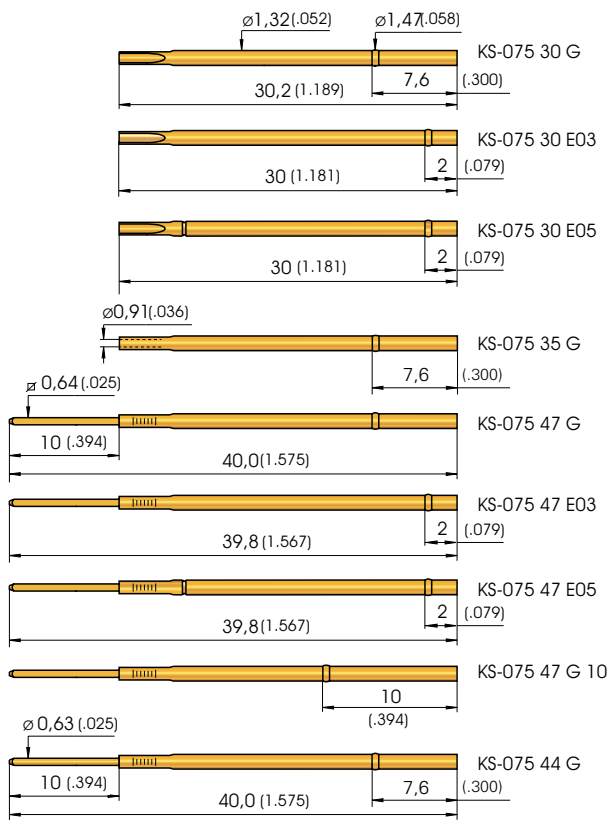

#### Collar Height and Installation Height

To adjust the Installation Height, Receptacles with a Press-ring are used. The Receptacles can be inserted up to the Press-ring (i.e. acting as a collar-stop) or with the Press-ring being pressed into the mounting hole. (See „Mounting hole size“ and Application example“ on this page).

Designation	GKS-075	GKS-075 ... L
KS-075 ... E03	10,5 (.413)	12,5 (.492)
KS-075 ... E05	13,0 (.512)	15,0 (.591)
KS-075 ... G	16,0 (.630)	18,0 (.709)
KS-075 ... G 10	18,0 (.709)	20,0 (.787)

#### Mounting Hole Size

**by usage of Press-ring:**  $\varnothing 1,36 - 1,40$  mm  
 (.0535 - .0551)

**by usage with Press-ring as collar:**  $\varnothing 1,31 - 1,32$  mm  
 (.0516 - .0520)

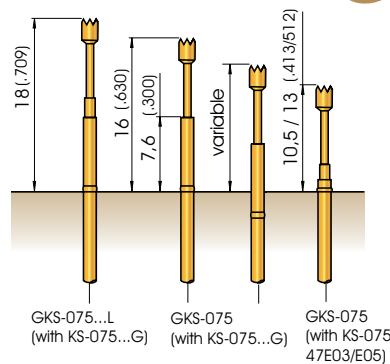

**Note:**  
 Receptacles for Wireless Test Fixture see page 38.

### Available Tip Styles

Material	Tip Style	Plating	Further Versions	
			$\varnothing$	$\varnothing$ (inch)
3	19	A	1,50	(.069)
2	24 ***	A		
2	25	A	1,30	(.051)
2	31	A		
2	38	A		
3	55	A		
2	77	A		
2	88	A		
2	89	A		
2	91	A		
2	97	A		
2	97	A		
2	98	A		

Additional dimensions for tip style 55:  $\varnothing 1,2$ ,  $\varnothing 1$ , 3,7, 2,54,  $\varnothing 0,50$ . Total Length plus 2,4 mm.

NEW

NEW

\*\*\* higher middle tip plus 0,2 mm

### Ordering Example

Receptacles with Wire-Wrap Posts:

KS-075 47 E03    KS-075 47 E05    KS-075 47 G

Receptacles:

KS-075 30 G    KS-075 35 G

Receptacles with Round Post:

KS-075 44 G

# GKS 100

ICT-/FCT Test Probe

## Grid:

≥ 2,54 mm

≥ 100 Mil

Installation Height: 10,5 - 21,0 mm (.413 - .827)

Recommended Stroke: 4,3 mm (.169)

## Mounting and Functional Dimensions

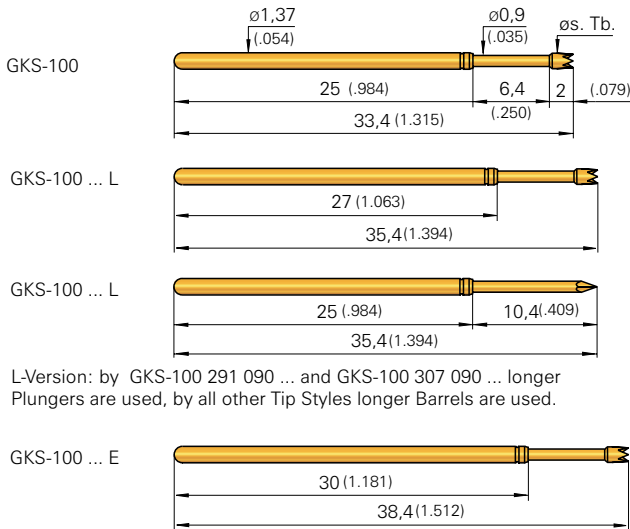

L-Version: by GKS-100 291 090 ... and GKS-100 307 090 ... longer Plungers are used, by all other Tip Styles longer Barrels are used.

## Collar Height and Installations Height

To adjust the Installations Height, use Receptacles (KS) either with Collar or with Press-ring (see Usage Examples on Page 29).

Wire-Wrap	Solder Cap	GKS-100	GKS-100 ... L	GKS-100 ... E
KS-100 47 05	KS-100 30 05	10,5 (.413)	12,5 (.492)	15,5 (.610)
KS-100 47 25	KS-100 30 25	13,0 (.512)	15,0 (.591)	18,0 (.709)
KS-100 47 40	KS-100 30 40	14,5 (.571)	16,5 (.650)	19,5 (.768)
KS-100 47	KS-100 30	16,0 (.630)	18,0 (.709)	21,0 (.827)
KS-100 47 G	KS-100 30 G KS-100 44 G	16,0 (.630)/var.	18,0 (.709)/var.	21,0 (.827)/var.
KS-100 47 G12	KS-100 30 G12	20,5 (.810)/var.	22,5 (.890)/var.	25,5 (1.000)/var.

## Mechanical Data

**Working Stroke:** 4,3 mm (.169)  
**Maximum Stroke:** 6,35 mm (.250)  
**Spring Force at Work. Stroke:** 2,0 N (7.2oz)  
**alternative:** 0,6 N (2.2oz); 1,0 N (3.6oz);  
 1,5 N (5.4oz); 2,25 N (8.1oz);  
 3,0 N (10.8oz), 4,0 N (14,4oz)

## Electrical Data

**Current Rating:** 5 - 8 A  
**R<sub>i</sub> typical:** < 20 mΩ (\*\*\*) < 100 mΩ

## Operating Temperature

**Standard:** -40° up to +80° C  
**\*\*\*with Special Designation "C":** -100° up to +200°C (1,5 N; 2,0 N; 3,0 N)  
 C-Versions only available for GKS-100 with total length 33,4 mm (1.315).

## Materials

**Plunger:** BeCu or Steel, gold-plated  
**Barrel:** Nickel-Silver or Bronze, gold-plated  
**Spring:** Steel, gold-plated or stainless steel\*\*\* (C)  
**Receptacle:** Nickel-silver or Brass, gold-plated

## Mounting Hole Size

For KS-100...G when pressing the Press-ring into the Mounting Hole in Material:  
**CEM 1 and FR 4:**  $\varnothing$  1,70 - 1,75 mm (.0669 - .0689)

For KS-100 with Collar or Press-ring as a collar-stop:  
**CEM 1:**  $\varnothing$  1,68 - 1,69 mm (.0665 - .0665)  
**FR 4:**  $\varnothing$  1,69 - 1,70 mm (.0665 - .0669)

## Available Tip Styles

Material	Tip Style	Plating	Further Versions	
			$\varnothing$	$\varnothing$ (inch)
0 06*		A		
0 06*		A		
2 01		A		
3 02		A	0,90 (.035)	
3 03		A		
2 04		A		
2 04		A	1,50 (.059)	
3 05		A	0,50 (.020) 0,64 (.025) 1,30 (.051)	
3 06		A	1,50 (.059) 2,00 (.079) 2,50 (.098) 3,00 (.118)	
3 07		A		
3 07		A	1,70 (.067) 2,50 (.098)	
2 09		A		
3 13		A		
2 14		A	0,80 (.031)	
2 14		A		
2 14		A	1,50 (.059)	
3 14		A		
2 17		A		
3 19		A		
2 24**		A	1,50 (.059)	

\* 0,9 mm or 0,5 mm longer than Standard  
 \*\* higher middle tip, 0,4 mm longer than Standard

**Note:** Receptacles for Wireless Test Fixture see on page 38.

**Tools:** Insertion and Extraction Tools for GKS and KS see Page 118.

**Grid:**  
≥ 2,54 mm  
≥ 100 Mil

**Installation Height:** 10,5 - 21,0 mm (.413 - .827)  
**Recommended Stroke:** 4,3 mm (.169)

## Mounting and Functional Dimensions

### Receptacles with Collar

With Wire-Wrap Posts (vacuum-sealed)

With Solder Connection **NEW**

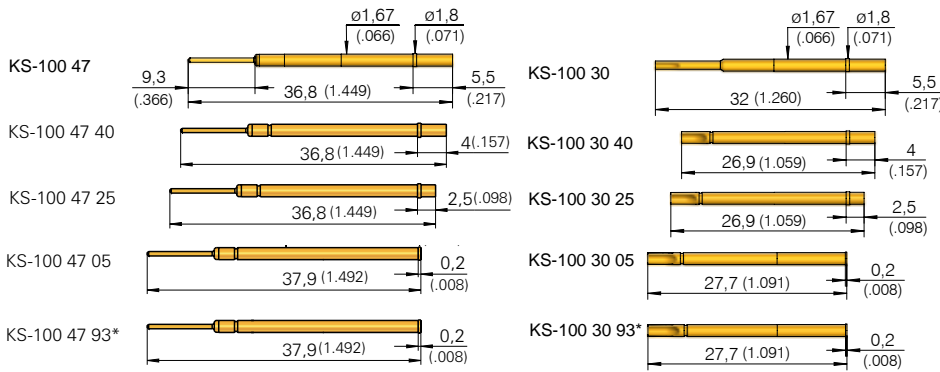

\* for usage with Tip Style 93

### Receptacles with Press-ring

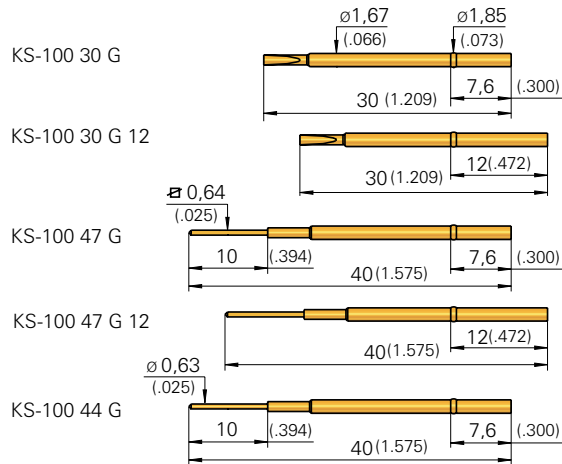

### Example with GKS-100 (Total Length GKS = 33,4 (1.315))

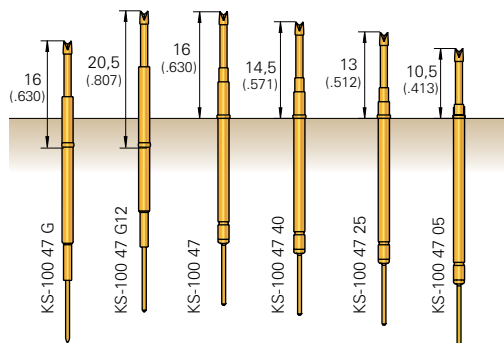

**Note to GKS-100 with Tip Style 93:**  
- Installation Height with KS-100 30/47: 21,0 mm (.827)  
- Installation Height with KS-100 47 93: 16,0 mm (.630)

It is recommended to use Tip Style "93" in combination with the Test Probe series "GKS-100 ...E"

**Note:**  
Receptacles with square-post length 13 mm (.512) and 18 mm (.709) are ordered with the Designation "-13" resp. "-18"  
Example: KS-100 47 G 12-13 (-18)  
KS-100 47-13 (-18)

## Ordering Example

Series	Tip Material	Tip Style	Tip Diameter (1/100 mm)	Plating	Spring Force (dN)	Collar Height (mm)	Special Designation („C“, „E“, „L“)
Test Probe with total Length 33,4 mm (1.315):	2 = Steel	3 07	150	A = Gold	30	00	
Test Probe with total Length 35,4 mm (1.394):	3 = BeCu	2 91	090	A = Gold	20	00	L
Test Probe with total Length 38,4 mm (1.512):		3 06	130	A = Gold	15	00	E
Receptacles:		KS-100 30 G	KS-100 47 G				



# GKS 035

Long-stroke Test Probe for dual-Stage Fixtures

**Grid:**

≥ 1,91 mm

≥ 75 Mil

**Installation Height:** 14,2/16,7/19,7 mm/var. (.559/ .657/ .776)

**Recommended Stroke:** 8,0 mm (.315)

## Mounting and Functional Dimensions

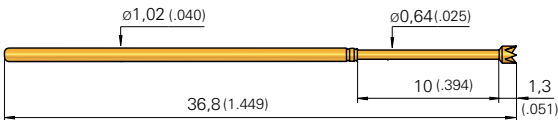

GKS-035

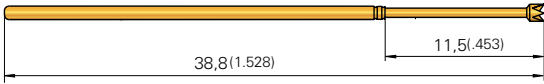

GKS-035 ... L

## Receptacles

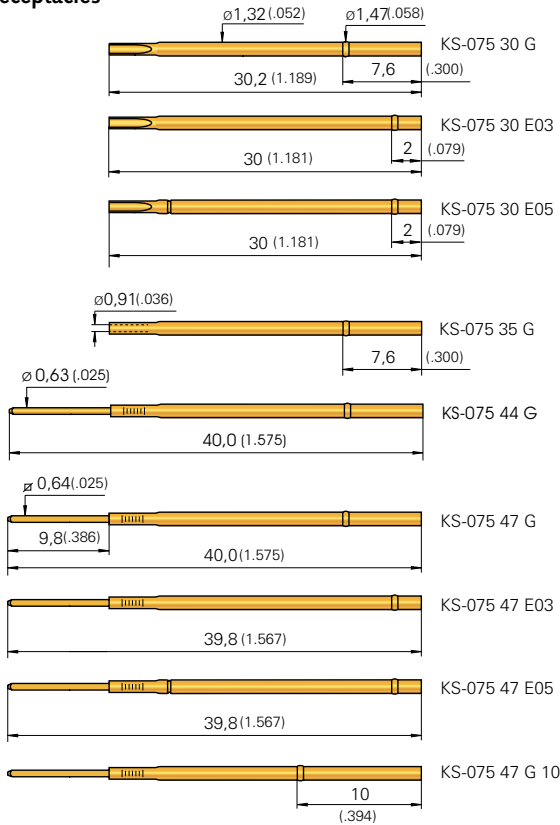

### Mechanical Data

**Working Stroke:** 8,0 mm (.315)  
**Maximum Stroke:** 10,0 mm (.394)  
**Spring Force at Work. Stroke:** 1,2 N (4.3oz)

### Electrical Data

**Current Rating:** 3 - 4 A  
**R<sub>i</sub> typical:** < 20 mΩ

### Materials

**Plunger:** BeCu or Steel, gold-plated  
**Barrel:** Nickel-Silver or Bronze, gold-plated  
**Spring:** Steel, gold-plated  
**Receptacles:** Nickel-Silver, gold-plated

### Mounting Hole Size

see Probe series GKS-075, Page 25

## Available Tip Styles

Material	Tip Style	Plating	Further Versions	
			∅	∅ (inch)
3 06		A	∅ 1,15 (.045)	
2 07		A	∅ 1,15 (.045)	
2 14		A	∅ 1,15 (.045)	0,64 (.025)
2 91		A	∅ 0,64 (.025)	

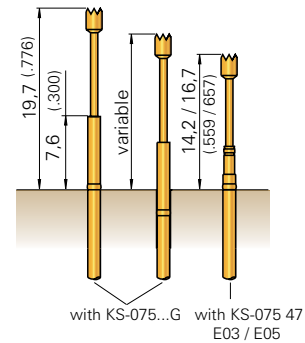

### Collar Height and Installation Height

To adjust the Installation Height Receptacles with a Press-ring are used.

Designation	Installation Height
KS-075 ... E03	14,2 mm/var. (.559)
KS-075 ... E05	16,7 mm/var. (.657)
KS-075 ... G	19,7 mm/var. (.776)

**Note:**

For Test Probes series GKS-035 Receptacles of the series KS-075 are used (see Page 27).

## Ordering Example

	Series	Tip Material 2 = Steel 3 = BeCu	Tip Style	Tip Diameter (1/100 mm)	Plating A = Gold	Spring Force (dN)	Collar Height (mm)	Special Designation
Test Probe with total Length 36,8 mm (1.449):	G K S	0 3 5	2 1 4	1 1 5	A	1 2	0 0	
Test Probe with total Length 38,8 mm (1.528):	G K S	0 3 5	2 9 1	0 6 4	A	1 2	0 0	L
Receptacles with Wire-Wrap post:	K S - 0 7 5 4 7 E 0 3		K S - 0 7 5 4 7 E 0 5		K S - 0 7 5 4 7 G			
Receptacles:	K S - 0 7 5 3 0 G		K S - 0 7 5 3 5 G					

**Grid:**  
 ≥ 2,54 mm  
 ≥ 100 Mil

**Installation Height:** 21,3 mm (.839)  
**Recommended Stroke:** 9,3 mm (.366)

### Mounting and Functional Dimensions

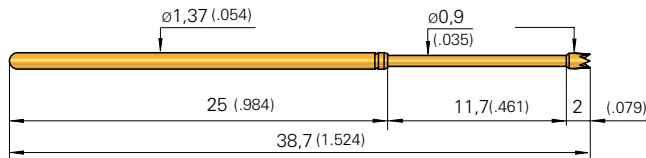

GKS-135

#### Collar Height and Installation Height

The Installation Height of the Test Probe is determined by the collar height of the Receptacle (KS).

Designation	Installation Height
KS-100 47 05	15,8 mm (.622)
KS-100 47 25	18,3 mm (.720)
KS-100 47 40	19,8 mm (.780)
KS-100 47 (G)	21,3 mm (.839) var.

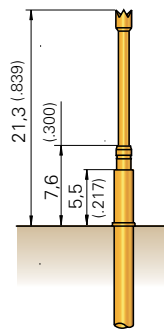

Application example with KS - 100 47

#### Mechanical Data

**Working Stroke:** 9,3 mm (.366)  
**Maximum Stroke:** 11,7 mm (.461)  
**Spring Force at Work. Stroke:** 2,0 N (7.2oz)  
**alternative:** 1,5 N (5.4oz); 3,0 N (10.8oz)

#### Materials

**Plunger:** Steel or BeCu, gold- or nickel-plated  
**Barrel:** Nickel-Silver or Bronze, gold-plated  
**Spring:** Steel, gold-plated

#### Electrical Data

**Current Rating:** 5 - 8 A  
**R<sub>i</sub> typical:** < 30 mΩ

#### Mounting Hole Size

see Probe series GKS-100, Page 28

### Available Tip Styles

Material	Tip Style	Plating	Further Versions	
			∅	∅ (inch)
2 01		A	∅ 0,90 (.035)	
3 02		A	∅ 0,90 (.051)	
3 03		A	∅ 1,30 (.035)	
2 04		A	∅ 1,30 (.051)	
3 06		A	∅ 1,30 (.051)	
3 06		A	∅ 1,50 (.059)	
3 07		A	∅ 1,50 (.059)	2,50 (.098)
2 09*		N	∅ 0,50 (.020)	
2 14		A	∅ 0,50 (.020)	
2 14		A	∅ 1,30 (.051)	
2 14		A	∅ 1,50 (.059)	
2 25		A	∅ 1,30 (.051)	
2 91		A	∅ 0,90 (.035)	
2 97		A	∅ 0,90 (.035)	

\* Installation Height with KS-100 47: 23,3 mm (.917)  
 Maximum Stroke: 11,0 mm (.433)

### Ordering Example

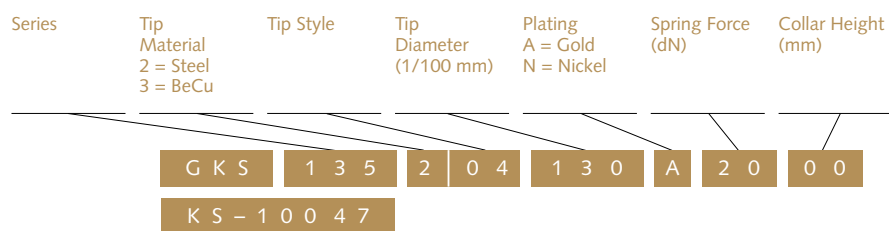

Test Probe:

Receptacle:

#### Note:

For Test Probes series GKS-135 Receptacles of the series KS-100 are used (see Page 29).

#### Tools:

Insertion and Extraction Tools for GKS and KS see Page 118.

# GKS 101

Test Probe

**Grid:**

≥ 1,91 mm

≥ 75 Mil

**Installation Height:** 12,5 mm (.492)

**Recommended Stroke:** 4,0 mm (.157)

## Mounting and Functional Dimensions

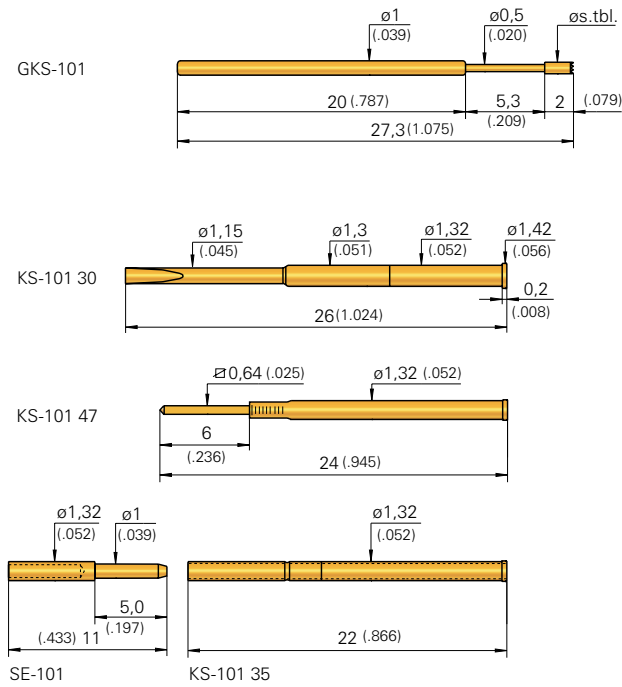

### Collar Height an Installation Height

The Installation Height of the Test Probe is determined by the collar height of the Receptacle (KS).

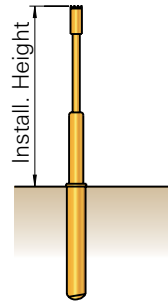

Designation	Installation Height
KS-101 30 / 35 / 47	12,5 mm (.492)
KS-101 xx E13	14,0 mm (.551)

Further Installation Heights on request.

### Mechanical Data

**Working Stroke:** 4,0 mm (.157)  
**Maximum Stroke:** 5,3 mm (.209)  
**Spring Force at Work. Stroke:** 0,8 N (2.9oz)  
**alternative:** 0,5 N (1.8oz); 1,5 N (5.4oz)

### Electrical Data

**Current Rating:** 3 - 4 A  
**R<sub>j</sub> typical:** < 20 mΩ (\* < 100 mΩ)

### Mounting Hole Size

**in CEM 1 and FR 4:**  $\phi$  1,31 - 1,32 mm (.0516 - .0520)

### Materials

**Plunger:** BeCu or Steel, gold-plated  
**Barrel:** Nickel-Silver, gold-plated  
**Spring:** Steel, gold-plated or Stainless Steel\* (C)  
**Receptacle:** Brass or Nickel-Silver, gold-plated

### Operating Temperature

**Standard:** -40° up to +80° C  
**\* with spec. Designation "C":** -100° up to +200° (0,8 N)

## Available Tip Styles

Material	Tip Style	Plating	Further Versions	
			$\phi$	$\phi$ (inch)
3	01	A		
3	02	A	0,50	(.020)
3	03	A	1,50	(.059)
3	04	A		
3	05	A		
3	06	A	1,50	(.059)
3	07	A		
3	08	A		
3	14	A		
2	24	A		
**				
3	51	A		

2 mm (.079) shorter  $\phi 0,50$  (.020)

\*\* higher middle tip plus 0,5 mm

### Tools:

Insertion and Extraction Tools for GKS and KS see Page 118.

## Ordering Example

	Series	Tip Material 2 = Steel 3 = BeCu	Tip Style	Tip Diameter (1/100 mm)	Plating A = Gold	Spring Force (dN)	Collar Height (mm)
Test Probe:	GKS	101	301	050	A	08	00
Receptacles:	KS-10147	KS-10135	KS-10130E13				
Plug:	SE-101						



**Grid:**  
≥ 1,91 mm  
≥ 75 Mil

**Installation Height:** 8,5 mm (.335)/variable  
**Recommended Stroke:** 2,4 mm (.094)

## Mounting and Functional Dimensions

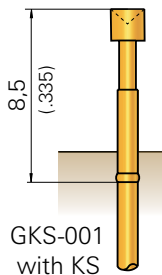
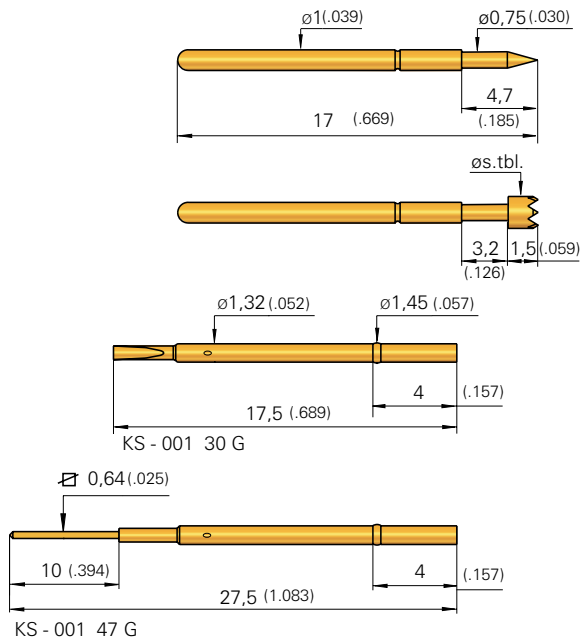

### Collar Height and Installation Height

To adjust the Installation Height, Receptacles with Press-ring (end-designation „G“) are used. The Installation Height can be variably set by assembling the Collar lower in the mounting hole.

### Mechanical Data

**Working Stroke:** 2,4 mm (.094)  
**Maximum Stroke:** 3,0 mm (.118)  
**Spring Force at Work. Stroke:** 1,0 N (3.6oz)  
**alternative:** 0,6 N (2.2oz); 1,5 N (5.4oz)

### Electrical Data

**Current Rating:** 3 - 4 A  
**R<sub>i</sub> typical:** < 20 m $\Omega$

### Operating Temperature

**Standard:** -40° up to +80° C

### Materials

**Plunger:** BeCu or Steel, gold-plated  
**Barrel:** Nickel-Silver or Bronze, gold-plated  
**Spring:** Steel, gold-plated  
**Receptacle:** Nickel-Silver, gold-plated

### Mounting Hole Size

**With Collar or Press-ring as a collar-stop in CEM 1 and FR 4:**  $\phi$  1,31 - 1,32 mm (.0516 - .0520)

### When pressing the Press-ring into the Mounting Hole

**in CEM 1 and FR 4:**  $\phi$  1,36 - 1,40 mm (.0535 - .0551)

		Available Tip Styles			
Material	Tip Style	Plating	Further Versions		
			$\phi$	$\phi$ (inch)	
2	01	A	$\phi$ 0,75 (.030)		
3	02	A	$\phi$ 1,50 (.059)		
3	03	A	$\phi$ 1,50 (.059)		
2	04	A	$\phi$ 1,50 (.059)		
3	05	A	$\phi$ 1,00 (.039)		
3	06	A	$\phi$ 1,00 (.039)		
3	06	A	$\phi$ 1,50 (.059)		
3	07	A	$\phi$ 1,50 (.059)		

### Tools:

Insertion and Extraction Tools for GKS and KS see Page 118.

## Ordering Example

Series	Tip Material 2 = Steel 3 = BeCu	Tip Style	Tip Diameter (1/100 mm)	Plating A = Gold	Spring Force (dN)	Collar Height (mm)
--------	---------------------------------------	-----------	----------------------------	---------------------	----------------------	-----------------------

Test Probe:

G K S 0 0 1 2 1 4 1 5 0 A 1 0 0 0

Receptacles:

K S - 0 0 1 3 0 G K S - 0 0 1 4 7 G

# GKS 002

ICT-/FCT Test Probe

**Grid:**

≥ 2,54 mm

≥ 100 Mil

**Installation Height:** 12,1 mm (.476)/variable

**Recommended Stroke:** 2,7 mm (.106)

## Mounting and Functional Dimensions

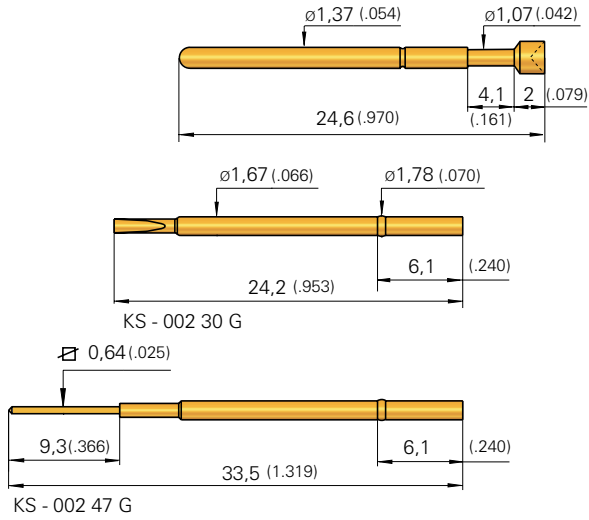

## Available Tip Styles

Material	Tip Style	Plating	Further Versions	
			∅	∅ (inch)
2	01	A	∅ 1,07 (.042)	
3	03	A	∅ 1,91 (.075)	
2	04	A	∅ 1,52 (.060)	
3	05	A	∅ 0,64 (.025)	
2	06	A	∅ 1,91 (.075)	
2	07	A	∅ 1,91 (.075)	
2	14	A	∅ 1,91 (.075)	
2	17	A	∅ 1,91 (.075)	

### Collar Height and Installation Height

To adjust the Installation Height, Receptacles with Press-ring (end-designation „G“) are used. The Installation Height can be variably set by assembling the Collar lower in the mounting hole.

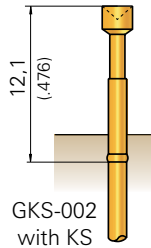

### Mechanical Data

**Working Stroke:** 2,7 mm (.106)  
**Maximum Stroke:** 4,1 mm (.161)  
**Spring Force at Work. Stroke:** 1,0 N (3.6oz)  
**alternative:** 1,8 N (6.5oz); 2,8 N (10.1oz)

### Materials

**Plunger:** BeCu or Steel, gold-plated  
**Barrel:** Nickel-Silver or Bronze, gold-plated  
**Spring:** Steel, gold-plated  
**Receptacle:** Nickel-Silver, gold-plated

### Electrical Data

**Current Rating:** 5 - 8 A  
**R<sub>j</sub> typical:** < 20 mΩ

### Mounting Hole Size

**With Collar or Press-ring as a collar-stop in CEM 1 and FR 4:** ∅ 1,68- 1,69 mm (.0642 - .0660)

**When pressing the Press-ring into the Mounting Hole**

**in CEM 1 and FR 4:** ∅ 1,70 - 1,75 mm (.0669 - .0689)

### Tools:

Insertion and Extraction Tools for GKS and KS see Page 118.

## Ordering Example

	Series	Tip Material 2 = Steel 3 = BeCu	Tip Style	Tip Diameter (1/100 mm)	Plating A = Gold	Spring Force (dN)	Collar Height (mm)
Test Probe:	GKS	002	303	191	A	10	00
Receptacle with Press-ring:	KS-00230G						

Grid:  
 ≥ 3,18 mm  
 ≥ 125 Mil

Installation Height: 16 mm (.630)/variable  
 Recommended Stroke: 4,4 mm (.173)

## Mounting and Functional Dimensions

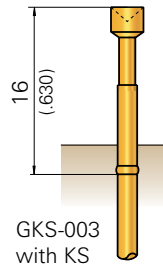
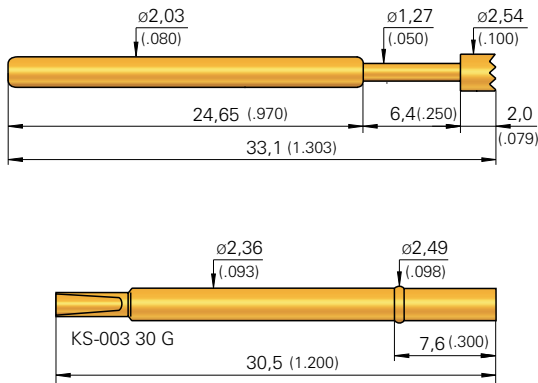

### Collar Height and Installation Height

To adjust the Installation Height, Receptacles with Press-ring (end-designation „G“) are used. The Installation Height can be variably set by assembling the Collar lower in the mounting hole.

### Mechanical Data

**Working Stroke:** 4,4 mm (.173)  
**Maximum Stroke:** 6,35 mm (.250)  
**Spring Force at Work. Stroke:** 2,0 N (7.2oz)  
**alternative:** 1,2 N (4.3oz); 3,0 N (10.8oz)

### Electrical Data

**Current Rating:** 5 - 8 A  
**R<sub>i</sub> typical:** < 20 mΩ

### Materials

**Plunger:** BeCu or Steel, gold-plated  
**Barrel:** Nickel-Silver or Bronze, gold-plated  
**Spring:** Steel, gold-plated  
**Receptacle:** Nickel-Silver, gold-plated

### Mounting Hole Size

**With Collar or Press-ring as a collar-stop in CEM 1 and FR 4:**  $\phi$  2,33- 2,34 mm (.0901 - .0906)

**When pressing the Press-ring into the Mounting Hole**

**in CEM 1 and FR 4:**  $\phi$  2,39 - 2,44 mm (.0941 - .0961)

		Available Tip Styles			
Material	Tip Style	Plating	Further Versions		
			$\phi$	$\phi$ (inch)	
2 01		A	$\phi$ 1,27 (.050)		
3 02		A	$\phi$ 1,00 (.039)		
3 02		A	$\phi$ 1,27 (.050)		
3 03		A	$\phi$ 2,54 (.100)		
2 04		A	$\phi$ 2,54 (.100)		
3 05		A	$\phi$ 1,27 (.050)		
3 05		A	$\phi$ 1,70 (.067)		
3 05		A	$\phi$ 2,54 (.100)		
2 06		A	$\phi$ 2,54 (.100)		
3 07		A	$\phi$ 2,54 (.100)	3,00 (.118)	
3 08		A	$\phi$ 2,54 (.100)		

### Tools:

Insertion and Extraction Tools for GKS and KS see Page 118.

## Ordering Example

Series	Tip Material 2 = Steel 3 = BeCu	Tip Style	Tip Diameter (1/100 mm)	Plating A = Gold	Spring Force (dN)	Collar Height (mm)
Test Probe:	G K S	0 0 3	3 0 3	2 5 4	A	2 0 0 0
Receptacle with Press-ring:	K S - 0 0 3 3 0 G					

# GKS 004

ICT-/FCT Test Probe

**Grid:**

≥ 4,75 mm

≥ 187 Mil

**Installation Height:** 16,5 mm (.650)/variable

**Recommended Stroke:** 4,4 mm (.173)

## Mounting and Functional Dimensions

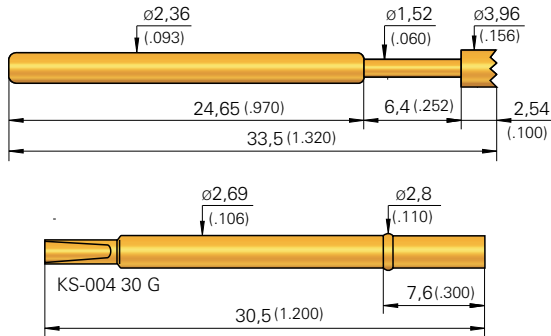

## Available Tip Styles

Material	Tip Style	Plating	Further Versions	
			∅	∅ (inch)
2	01	A	∅ 1,52 (.060)	
3	02	A	∅ 3,96 (.156)	
2	03	A	∅ 3,96 (.156)	
2	04	A	∅ 1,52 (.060)	
3	05	A	∅ 1,52 (.060)	
2	06	A	∅ 3,96 (.156)	
3	08	A	∅ 3,96 (.156)	

### Collar Height and Installation Height

To adjust the Installation Height, Receptacles with a Press-ring (end-designation „G“) are used. The Installation Height can be variably set by assembling the Collar lower in the mounting hole.

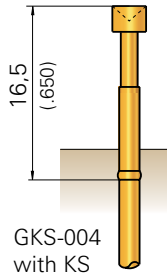

### Mechanical Data

**Working Stroke:** 4,4 mm (.173)

**Maximum Stroke:** 6,35 mm (.250)

**Spring Force at Work. Stroke:** 2,0 N (7.2oz)

**alternative:** 1,5 N (5.4oz); 3,0 N (10.8oz)

### Materials

**Plunger:** Steel, gold-plated

**Barrel:** Nickel-Silver or Bronze, gold-plated

**Spring:** Steel, gold-plated

**Receptacle:** Nickel-Silver, gold-plated

### Electrical Data

**Current Rating:** 6 - 8 A

**R<sub>j</sub> typical:** < 20 mΩ

### Mounting Hole Size

**With Collar or Press-ring as a collar-stop in CEM 1 and FR 4:** ∅ 2,67 - 2,68 mm (.1024 - .1063)

**When pressing the Press-ring into the Mounting Hole**

**KS-004 30 G:** ∅ 2,72 - 2,77 mm (.1071 - .1091)

### Tools:

Insertion and Extraction Tools for GKS and KS see Page 118.

## Ordering Example

Series	Tip Material 2 = Steel 3 = BeCu	Tip Style	Tip Diameter (1/100 mm)	Plating A = Gold	Spring Force (dN)	Collar Height (mm)
--------	---------------------------------------	-----------	----------------------------	---------------------	----------------------	-----------------------

Test Probe:

G K S 0 0 4 2 0 1 1 5 2 A 2 0 0 0

Receptacle with Press-ring:

K S - 0 0 4 3 0 G

**Grid:**  
 ≥ 4,75 mm  
 ≥ 187 Mil

**Installation Height:** 16,5 mm (.650)/variable  
**Recommended Stroke:** 4,4 mm (.173)

### Mounting and Functional Dimensions

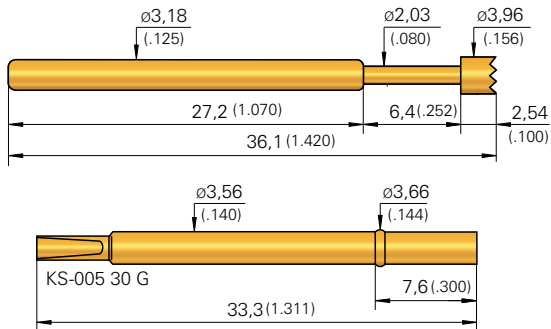

### Available Tip Styles

Material	Tip Style	Plating	Further Versions	
			∅	∅ (inch)
2 01		A	∅ 2,03 (.080)	
2 03		A	∅ 3,96 (.156)	
2 06		A	∅ 3,96 (.156)	

### Collar Height and Installation Height

To adjust the Installation Height, Receptacles with a Press-ring (end-designation „G“) are used. The Installation Height can be variably set by assembling the Collar lower in the mounting hole.

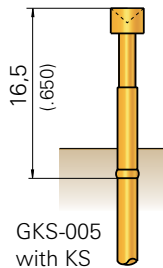

### Mechanical Data

**Working Stroke:** 4,4 mm (.173)  
**Maximum Stroke:** 6,35 mm (.250)  
**Spring Force at Work. Stroke:** 2,0 N (7.2oz)  
**alternative:** 3,0 N (10,8oz); 5,0 N (18.1oz)

### Materials

**Plunger:** Steel, gold-plated  
**Barrel:** Nickel-Silver or Bronze, gold-plated  
**Spring:** Steel, gold-plated  
**Receptacle:** Nickel-Silver, gold-plated

### Electrical Data

**Current Rating:** 6 - 8 A  
**R<sub>i</sub> typical:** < 20 mΩ

### Mounting Hole Size

**With Collar or Press-ring as a collar-stop in CEM 1 and FR 4:** ∅ 3,53- 3,54 mm (.1378 - .1399)

### When pressing the Press-ring into the Mounting Hole

**KS-005 30 G:** ∅ 3,58 - 3,63 mm (.1409 - .1429)

### Tools:

Insertion and Extraction Tools for GKS and KS see Page 118.

### Ordering Example

Series	Tip Material	Tip Style	Tip Diameter	Plating	Spring Force	Collar Height
	2 = Steel		(1/100 mm)	A = Gold	(dN)	(mm)

Test Probe:

G K S 0 0 5 2 0 6 3 9 6 A 3 0 0 0

Receptacle with Press-ring:

K S - 0 0 5 3 0 G

# KS WL / GKS-550

Wireless Receptacles  
Spring Loaded Receptacles

## Grid:

≥ 1.00 / 1,27 / 1,91 / 2,54 mm  
≥ 40 / 50 / 75 / 100 Mil

Installation Height: 16,0 mm (.630) / variable

Recommended Stroke: 2,5 mm (.098)

## Mounting and Functional Dimensions

### Wireless Receptacles

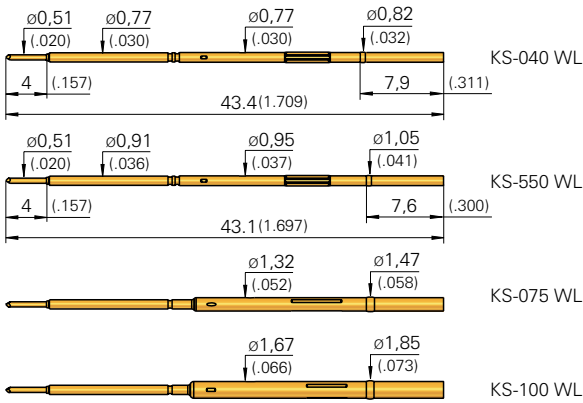

## Available Tip Styles

Plunger in Receptacle

Material	Tip Style	Plating	Further Versions	
			$\varnothing$	$\varnothing$ (inch)
3	07	A		

## Mechanical Data

**Working Stroke:** 2,5 mm (.098)  
**Maximum Stroke:** 4,0 mm (.157)  
**Spring Force at Work. Stroke:** 1,0 N (3.6oz)  
**Pre-load:** 0,6 N (2.2oz)  
**Pre-load KS-040 WL:** 0,5 N (1.8oz)  
**Recommended Guide Plate Hole:**  
 KS-040:  $\varnothing 0,81-0,85$  mm (.032 - .033)  
 KS-050, 075, 100:  $\varnothing 0,96-0,99$  mm (.036 - .039)

## Electrical Data

**Current Rating:** 2 - 3 A  
**R<sub>i</sub> typical:** < 20 m $\Omega$

## Operating Temperature

**Standard:** -40° up to +80° C

## Mounting Hole Sizes

### KS-040 WL

by usage of Press-ring or by usage of Press-ring as a collar:

**in CEM 1:**  $\varnothing 0,79-0,80$  mm (.0311-.0315)

**in FR 4:**  $\varnothing 0,79-0,80$  mm (.0311-.0315)

### KS-550 WL

by usage of Press-ring or by usage of Press-ring as a collar:

**in CEM 1:**  $\varnothing 0,96-0,98$  mm (.0378 - .0386)

**in FR 4:**  $\varnothing 0,97-0,99$  mm (.0382 - .0390)

### KS-075 WL

by usage of Press-ring in:

**CEM1/FR4:**  $\varnothing 1,36-1,40$  mm (.0535-.0551)

by usage of Press-ring as a collar in:

**CEM1/FR4:**  $\varnothing 1,31-1,32$  mm (.0516-.0520)

### KS-100 WL

by usage of Press-ring in:

**CEM1/FR4:**  $\varnothing 1,70-1,75$  mm (.0669-.0689)

by usage of Press-ring as a collar:

**in CEM 1:**  $\varnothing 1,68-1,69$  mm (.0661-.0665)

**in FR 4:**  $\varnothing 1,69-1,70$  mm (.0665-.0669)

## GKS-550

With KS-550 WL the Probe Series GKS-550 is used.

Available Tip Styles and Materials: see GKS-050 on page 25

## Mechanical Data GKS-550

**Working Stroke:** 4,3 mm (.169)  
**Maximum Stroke:** 6,35 mm (.250)  
**Spring Force at Work. Stroke:** 1,5 N (5.4oz)  
**alternative:** 1,0 N (3.6oz)

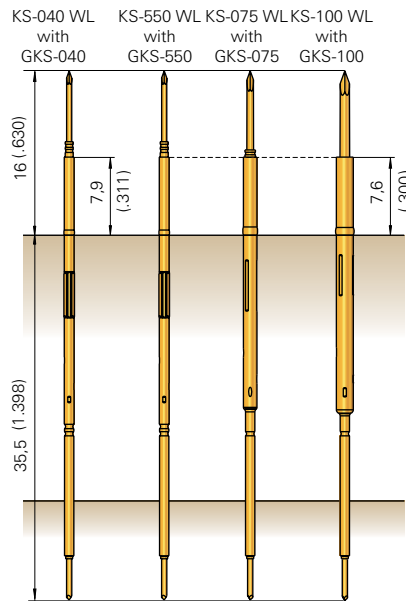
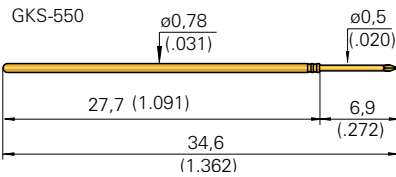

## Collar Height and Installation Height

To adjust the Installation Height, Receptacles with a Press-ring are used. The Receptacles can be inserted up to the Press-ring (i.e. acting as a collar-stop) or with the Press-ring being pressed into the mounting hole.

## Materials

**Plunger:** BeCu, gold-plated  
**Ball:** Steel, gold-plated  
**Spring:** Steel, gold-plated  
**Receptacle:** Nickel-silver, gold-plated

## Tools:

Insertion and Extraction Tools for GKS and KS see Page 118.

## Ordering Example

	Series	Tip Material 2 = Steel 3 = BeCu	Tip Style	Tip Diameter (1/100 mm)	Plating A = Gold	Spring Force (dN)	Collar Height (mm)
Test Probe for KS 550 WL:	G K S	2	5 5 0	9 1	A	1 5	0 0
Receptacle for Grid 1,00 mm (40 Mil):	K S - 0 4 0 W L		Test Probes see GKS-040 Page 24				
Receptacle for Grid 1,27 mm (50 Mil):	K S - 5 5 0 W L		Test Probes see GKS-550 above				
Receptacle for Grid 1,91 mm (75 Mil):	K S - 0 7 5 W L		Test Probes see GKS-075 Page 26/27				
Receptacle for Grid 2,54 mm (100 Mil):	K S - 1 0 0 W L		Test Probes see GKS-100 Page 28/29				

# The matching Tip-style for your Bead

For Bead Probe Technology – by which small beads of solder can be directly applied onto conductors or onto  $\mu$ Vias – INGUN has developed special tip-styles in close cooperation with global customers. INGUN has therefore the world's largest assortment of tip-style variants for the ideal contacting of the Beads.

Experience has shown that there is a multiple of different Bead geometries, compositions and surfaces, which need to be contacted.

For this reason, apart from the flat tip-style (# 02) in various diameters, the fine-serrated tip-style (# 60) and the tip-style # 79, with a number of contacting knife-shaped edges have been developed. The fine-serrated tip-style (# 60) is available in a number of tip-diameters and pitches of the points from 0.15 to 0.25 mm. Furthermore, the new star-type tip-style # 79 is available with various tip-diameters and a number of knife-shaped edges and their related angles.



The **Tip-style 02** – flat - is preferably used for flux-free and/or small Beads.

The **Tip-style 60** – fine-serrated – is recommended (due to the fine, aggressive points) for breaking open the surfaces of the Beads, which are coated with flux-deposits as well as for suitably large enough Beads. Decisive for the choice of this tip-style is the matching up of the pitch of the points of the tip in relation to the size of the Bead.

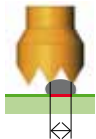

*Good matching up of the pitch of the points in relation to size of Bead*

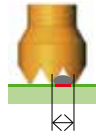

*Poor matching up of the pitch of the points in relation to size of Bead*



The **Tip-style 79** – Star - is recommended (due to the self-cleaning, horizontal arrangement of the knife-type edges) for "elongated/small" and "large" Beads with flux-deposits, that can stick to the tip. Decisive for the choice of the tip-style # 79 is the matching up of the Bead geometry and the angle of the knife-shaped edges as well as the most suitable contacting area (Note: usage of guide-plate in the Fixture is recommended).

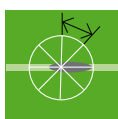

*Good matching up of contacting area and length of Bead.*



*Poor matching up of contacting area and angle of knife-edges too large for length of Bead.*

The INGUN Bead Probes are 100% compatible to the standard series GKS-050/075/100/135. Therefore all their related Receptacles and Tools can be used without exception.

You can find more information about Bead Probes under [www.ingun.com](http://www.ingun.com) in the Flyer "Bead Probe Contacting".

## Bead Probes

GKS-050	NEW	40
GKS-075	NEW	40
GKS-100	NEW	40
GKS-135	NEW	40



# GKS 050/075/100/135/550

ICT-/FCT Test Probes  
for Bead Probes Contacting

NEW

Grid:

≥ 1,27 / 1,91 / 2,54 mm

≥ 50 / 75 / 100 Mil

Installation Height: 16 mm (.630) / variable

Recommended Stroke: 4,3 mm (.169)

## Mounting and Functional Dimensions

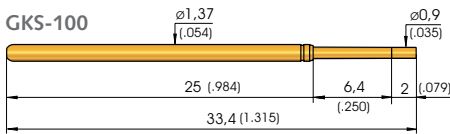
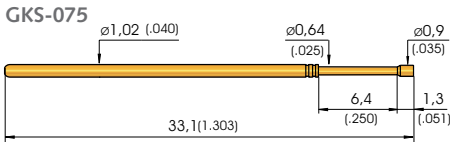
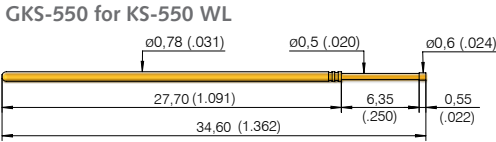
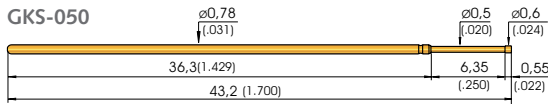

## Long-stroke Test Probe for dual-Stage Fixtures

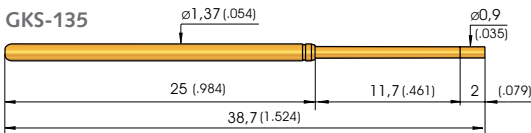

Available Tip Styles GKS-050/550			
Material	Style	Ø (inch)	Plating
3	02	Ø 0,60 (.024)	A
3	60	Ø 0,50 (.020)	A

Available Tip Styles GKS-050/550			
Material	Tip Style	Ø (inch)	Plating
3	60 Distance between points: 0,20 mm	Ø 0,60 (.024)	A
3	60 Distance between points: 0,25 mm	Ø 0,90 (.035)	A
3	79	Ø 0,50 (.020)	A

Available Tip Styles GKS-075			
Material	Style	Ø (inch)	Plating
3	02	Ø 0,90 (.035)	A
3	60 Distance between points: 0,20 mm	Ø 0,64 (.025)	A

Available Tip Styles GKS-075			
Material	Tip Style	Ø (inch)	Plating
3	60 Distance between points: 0,20 mm	Ø 0,90 (.035)	A
3	79	Ø 0,64 (.025)	A

Available Tip Styles GKS-100			
Material	Style	Ø (inch)	Plating
3	02	Ø 0,90 (.035)	A
3	02	Ø 1,50 (.060)	A
3	60 Distance between points: 0,20 mm	Ø 0,64 (.025)	A

Available Tip Styles GKS-100			
Material	Tip Style	Ø (inch)	Plating
3	60 Distance between points: 0,20 mm	Ø 0,90 (.035)	A
3	79	Ø 0,90 (.035)	A
3	79	Ø 0,64 (.025)	A

Available Tip Styles GKS-135			
Material	Style	Ø (inch)	Plating
3	02	Ø 0,90 (.035)	A
3	60 Distance between points: 0,20 mm	Ø 0,90 (.035)	A

### Mechanical Data

Work. Stroke: 050/075/100/550 4,3 mm (.169)

Max. Stroke: 050/075/100/550 6,35 mm (.250)

Work. Stroke: 135 9,3 mm (.366)

Max. Stroke: 135 11,35 mm (.448)

Spring Force of GKS-050/550:

Spring Force at Work. Stroke: 1,5 N (5.4oz)  
alternative: 1,0 N (3.6oz); 2,0 N (7.2oz) (not for GKS-550)

Spring Force of GKS-075:

Spring Force at Work. Stroke: 1,5 N (5.4oz)  
alternative: 1,0 N (3.6oz); 2,0 N (7.2oz)

2,8 N (10.1oz)

### Materials

Plunger: BeCu, gold-plated

Barrel: Nickel-silver or Bronze, gold-plated

Spring: Steel, gold-plated

Receptacle: Nickel-silver or Brass, gold-plated

Spring Force of GKS-100:

Spring Force at Work. Stroke: 1,5 N (3.6oz)  
alternative: 2,0 N (7.2oz); 3,0 N (10.8oz)

Spring Force of GKS-135:

Spring Force at Work. Stroke: 1,5 N (5.4oz)  
alternative: 2,0 N (7.2oz); 3,0 N (10.8oz)

### Operating Temperature

Standard: -40° up to +80° C

### Note:

Collar Height and Installation Height, Receptacles, Electrical Data, Mounting Hole Size: see compatible standard Probe Series.

### Tools:

Insertion and Extraction Tools for GKS and KS see Page 118.

## Ordering Example

Series	Tip Material 3 = BeCu	Tip Style	Tip Diameter (1/100 mm)	Plating A = Gold N = Nickel	Spring Force (dN)	Collar Height (mm)
--------	--------------------------	-----------	----------------------------	-----------------------------------	----------------------	-----------------------

Test Probes:

G	K	S	0	5	0	3	6	0	0	6	0	A	1	5	0	0
G	K	S	5	5	0	3	6	0	0	6	0	A	1	5	0	0
G	K	S	0	7	5	3	6	0	0	9	0	A	2	0	0	0
G	K	S	1	0	0	3	6	0	0	9	0	A	2	0	0	0
G	K	S	1	3	5	3	6	0	0	9	0	A	2	0	0	0



# Fine Pitch

For Fine Pitch applications it must be decided whether the Test Probe is used with a Receptacle or not. If the Test Probe is used with a Receptacle, then the Test Probe is changed in the common way from above, without removing the electrical connection. To avoid the time-consuming and costly wiring of the Receptacles in the case of Fine-Pitch applications, however, then the use of pre-wired Receptacles is preferred.

When using Test Probes with a plug, then use of a Receptacle is no longer necessary. Subsequently, the Test Probes can be used in a smaller pitch. The plugs are normally pressed or glued into a mounting plate. The Test Probes are float-mounted in a guide plate and are then centered and secured by means of a mounting plate.

**This method of customizing has the following advantages:**

- Contacting smaller Pads
- Reduced wobble of the Test Probe due to close guidance of the mounting plate.
- Usage in grids smaller than when using Receptacles.
- Sandwich design of the Fixture is possible.
- Larger bore-hole tolerances of the guide plate are allowed.

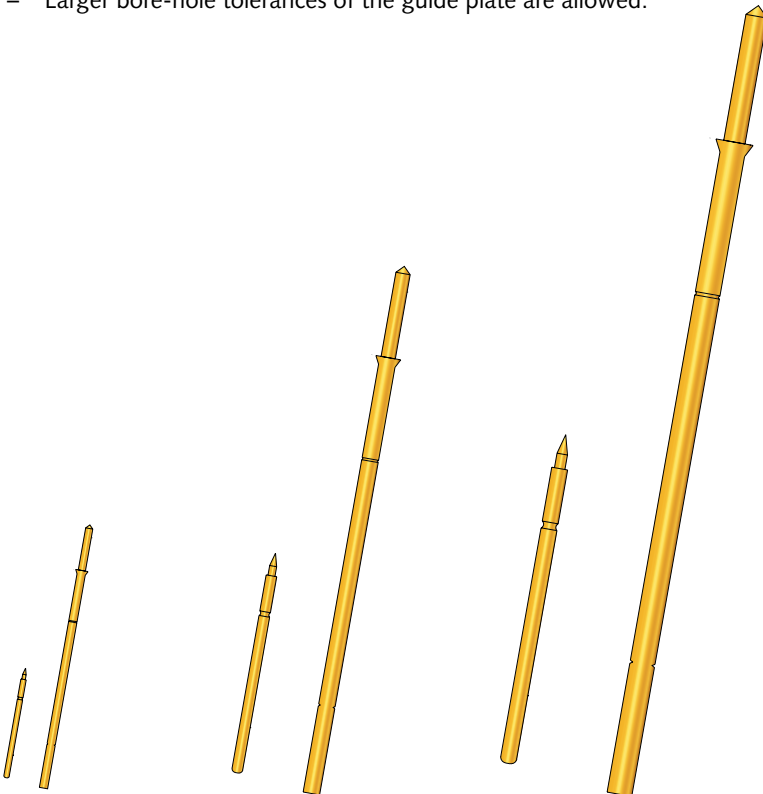

# Fine Pitch (≤1,27 mm)

GKS-038	42
GKS-041	42
GKS-061	42
GKS-080	43
GKS-081	44
GKS-069	45
GKS-079	46
GKS-181	47

# GKS 038/GKS 041/GKS 061

Micro-Contacting

**Grid:**

≥ 0,635 mm

≥ 25 Mil

**Installation Height:** 4,0 mm (.157)

**Recommended Stroke:** 2,0 mm (.079)

## GKS 038

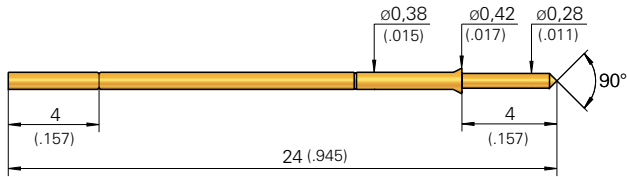

pre-wired Version with Wire AWG 30: see Example below

### Available Tip Styles

Material	Tip Style	Plating	Further Versions	
			∅	∅ (inch)
3 02		A		
3 08		A		

## GKS 041

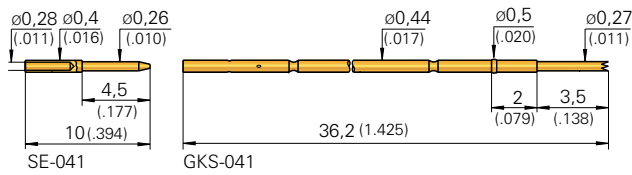

**Grid:**

≥ 0,7 mm

≥ 28 Mil

**Installation Height:** 5,5 mm (.217)

**Recommended Stroke:** 2,5 mm (.098)

### Available Tip Styles

Material	Tip Style	Plating	Further Versions	
			∅	∅ (inch)
3 04		A		

## GKS 061

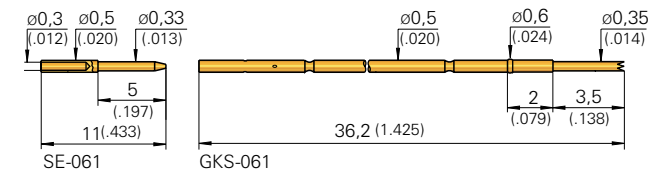

**Grid:**

≥ 0,8 mm

≥ 30 Mil

**Installation Height:** 5,5 mm (.217)

**Recommended Stroke:** 2,5 mm (.098)

### Available Tip Styles

Material	Tip Style	Plating	Further Versions	
			∅	∅ (inch)
3 04		A		

### Mechanical Data

	GKS 038	GKS 041	GKS 061
<b>Working Stroke:</b>	2,0 mm (.079)	2,5 mm (.098)	2,5 mm (.098)
<b>Maximum Stroke:</b>	2,5 mm (.098)	3,5 mm (.138)	3,5 mm (.138)
<b>Spring Force at Work.Stroke:</b>	0,4 N (1.4oz)	0,4 N (1.4oz)	0,6 N (2.2oz)

### Electrical Data

	GKS 038	GKS 041	GKS 061
<b>Current Rating:</b>	1 A	2 A	2 A
<b>R<sub>i</sub> typical:</b>	< 100 mΩ	< 50 mΩ	< 50 mΩ

### Mounting Hole Size

	GKS 038	GKS 041	GKS 061
	∅ 0,38 mm (.0150)	∅ 0,44 mm (.0173)	∅ 0,5 mm (.0197)

### Materials

<b>Plunger:</b>	BeCu, gold-plated
<b>Barrel:</b>	Bronze, gold-plated
<b>Spring:</b>	Steel, gold-plated
<b>Plug:</b>	Brass, gold-plated

### Note:

This Test Probe is available pre-wired with 1 m Wire AWG 30: see Ordering Example.

## Ordering Example

	Series	Tip Material 3 = BeCu	Tip Style	Tip Diameter (1/100 mm)	Plating A = Gold	Spring Force (dN)	Collar Height (mm)	Special Designation
Test Probe:	G K S	0 3 8	3	0 8	0 2 8	A	0 4	0 0
Test Probe (pre-wired with AWG 30):	G K S	0 3 8	3	0 8	0 2 8	A	0 4	0 0 V
Test Probe:	G K S	0 4 1	3	0 4	0 2 7	A	0 4	0 2
Test Probe:	G K S	0 6 1	3	0 4	0 3 5	A	0 6	0 2
Plugs for direct connection to GKS:	S E - 0 4 1		S E - 0 6 1					

Grid:  
≥ 1,00 mm  
≥ 40 Mil

Installation Height: 10,5 mm (.413)  
Recommended Stroke: 3,0 mm (.118)

## Mounting and Functional Dimensions

### without Receptacle

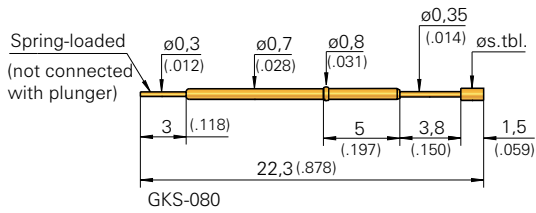

### with Receptacle

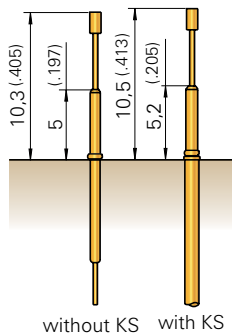
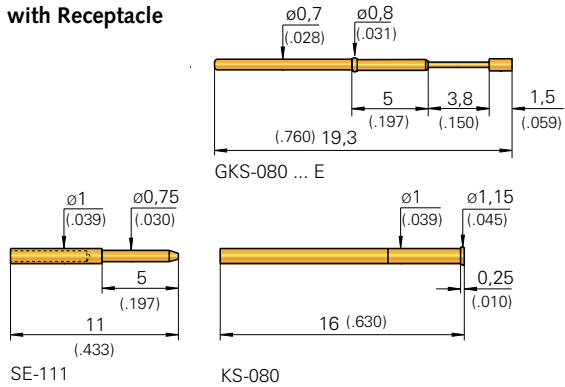

### Collar Height and Installation Height

The Installation Height of the Tip (Dimension without KS) is defined by the Collar Height of the Test Probe.

Collar Height 05:  
Installation Height 10,3 mm (.405)  
(without Receptacle)

## Available Tip Styles

Material	Tip Style	Plating	Further Versions	
			∅	∅ (inch)
3	01	A		
3	02	A		
3	03	A		
3	04	A	0,50	(.020)
3	05	A		
3	08	A		

### Mechanical Data

**Working Stroke:** 3,0 mm (.118)  
**Maximum Stroke:** 3,8 mm (.150)  
**Spring Force at Work. Stroke:** 0,8 N (2.9oz)

### Materials

**Plunger:** BeCu, gold-plated  
**Barrel:** Brass, gold-plated  
**Spring:** Steel, gold-plated  
**Receptacle:** Brass, gold-plated

### Note:

When using Receptacles choose Probe version GKS-080 ... E (Version without Solder-cup).

The Receptacle can be used from Grid 1,27 (50 Mil) up.

### Electrical Data

**Current Rating:** 3 A  
**R<sub>i</sub> typical:** < 20 mΩ

### Mounting Hole Size

**with Receptacle:** ∅ 0,99 - 1,00 mm (.039 - .0394)  
**without Receptacle:** ∅ 0,70 mm (.0276)

### Tools:

Insertion and Extraction Tools for GKS and KS see Page 118.

## Ordering Example

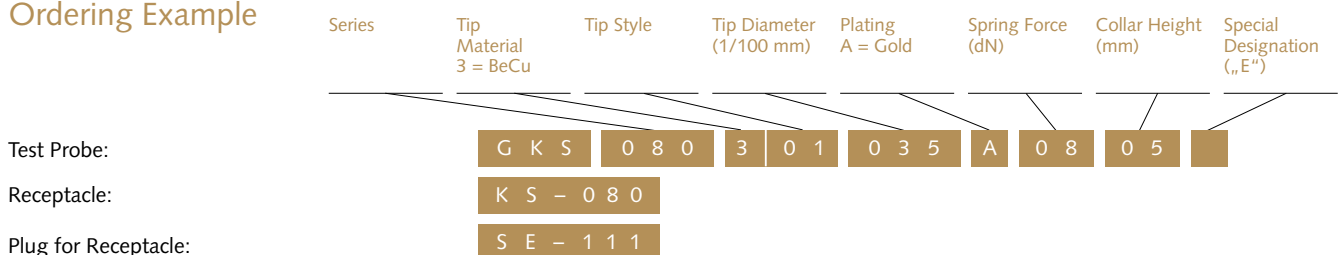

# GKS 081

Test Probe for contacting in SMD-Technology

## Grid:

≥ 1,00 mm

≥ 40 Mil

Installation Height: 10,5/13,0/16,0 mm (.413/ .512/ .630)

Recommended Stroke: 5,5 mm (.217)

## Mounting and Functional Dimensions

### without Receptacle

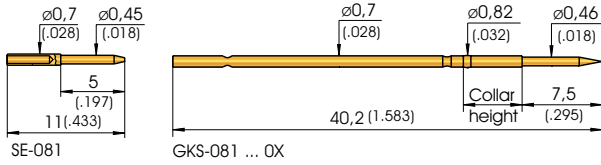

### with Receptacle

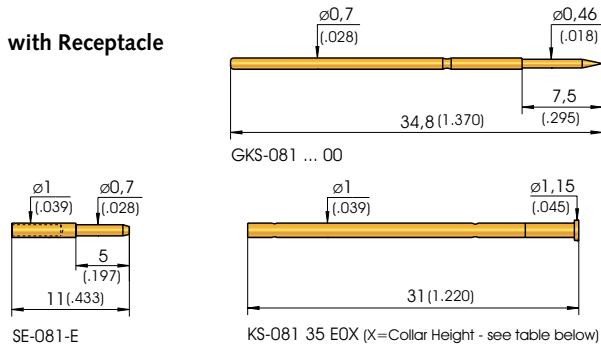

## Available Tip Styles

Material	Tip Style	Plating	Further Versions	
			∅	∅ (inch)
3	51	A	∅ 0,50 (.020)	
3	54	A	∅ 0,50 (.020)	
2	91	A	∅ 0,50 (.020)	

### Collar Height and Installation Height

To adjust the Installation Height of the Test Probes, Receptacles with various Collar Height are available.

Collar Height	Installation Height
03	10,5 mm (.413)
05	13,0 mm (.512)
08	16,0 mm (.630)

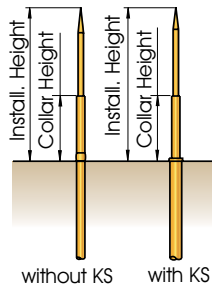

### Mechanical Data

**Working Stroke:** 5,5 mm (.217)  
**Maximum Stroke:** 7,5 mm (.295)  
**Spring Force at Work. Stroke:** 0,8 N (2.9oz)

### Materials

**Plunger:** BeCu or Steel, gold-plated  
**Barrel:** Brass, gold-plated  
**Spring:** Steel, gold-plated  
**Receptacle:** Brass, gold-plated

### Note:

The Receptacle can be used from Grid 1,27 (50 Mil) up.

### Electrical Data

**Current Rating:** 3 A  
**R<sub>j</sub> typical:** < 30 mΩ

### Mounting Hole Size

**with Receptacle:** ∅ 0,99 - 1,00 mm (.039 - .0394)  
**without Receptacle:** ∅ 0,70 mm (.0276)

### Tools:

Insertion and Extraction Tools for GKS and KS see Page 118.

## Ordering Example

Series	Tip Material 2 = Steel 3 = BeCu	Tip Style	Tip Diameter (1/100 mm)	Plating A = Gold	Spring Force (dN)	Collar Height (mm)
--------	---------------------------------------	-----------	----------------------------	---------------------	----------------------	-----------------------

Test Probe for usage **without** Receptacle:

G K S 0 8 1 3 5 4 0 5 0 A 0 8 0 3

Test Probe for usage **with** Receptacle:

G K S 0 8 1 3 5 4 0 5 0 A 0 8 0 0

Receptacles:

K S - 0 8 1 3 5 E 0 3    K S - 0 8 1 3 5 E 0 5    K S - 0 8 1 3 5 E 0 8

Plug for direct connection to Probe (GKS):

S E - 0 8 1

Plug for Receptacle:

S E - 0 8 1 E

**Grid:**  
 ≥ 1,27 mm  
 ≥ 50 Mil

**Installation Height:** 6,7 mm (.264) / variable  
**Recommended Stroke:** 2,2 mm (.087)

### Mounting and Functional Dimensions

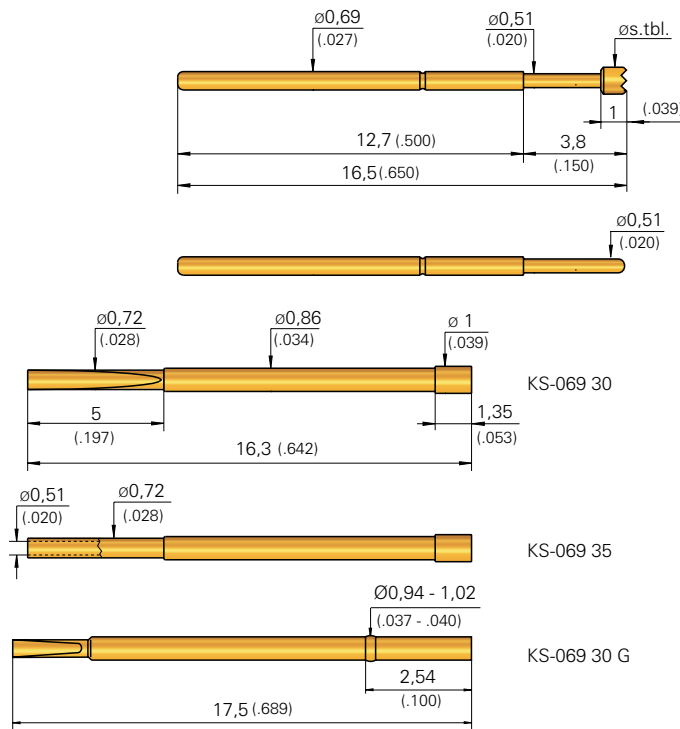

### Collar Height and Installation Height

The Installation Height of the Probe is determined by the Receptacle.

Designation	Installation Height
KS-069 30	6,7 mm (.264)
KS-069 35	6,7 mm (.264)
KS-069 30 G	variable

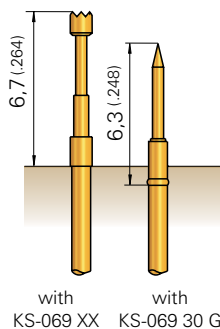

### Mechanical Data

**Working Stroke:** 2,2 mm (.087)  
**Maximum Stroke:** 2,8 mm (.110)  
**Spring Force at Work. Stroke:** 0,7 N (2.5oz)  
**alternative:** 1,0 N (3.6oz)

### Materials

**Plunger:** BeCu or Steel, gold-plated or chemically nickel-plated  
**Barrel:** Nickel-Silver, gold-plated  
**Spring:** Steel, gold-plated  
**Receptacle:** Brass or Nickel-Silver, gold-plated

### Electrical Data

**Current Rating:** 3 A  
**R<sub>i</sub> typical:** < 20 mΩ

### Mounting Hole Size

**for KS-069 30 / 35:**  $\varnothing 0,85 - 0,86$  mm (.0335 - .0339)  
**for KS-069 30 G:**  $\varnothing 0,86 - 0,92$  mm (.0339 - .0362)

		Available Tip Styles			
Material	Tip Style	Plating	Further Versions		
			$\varnothing$	$\varnothing$ (inch)	
2	01	N	$\varnothing 0,51$ (.020)	0,51 A (.020)	
3	03	A	$\varnothing 0,90$ (.035)	1,52 (.060)	
2	05	N	$\varnothing 0,51$ (.020)		
3	05	A	$\varnothing 0,51$ (.020)		
3	05	A	$\varnothing 0,80$ (.031)		
3	06	A	$\varnothing 0,90$ (.035)		
3	07	A	$\varnothing 0,90$ (.035)		
2	14	A	$\varnothing 0,90$ (.035)		
2	17	A	$\varnothing 0,90$ (.035)		

### Note:

The usage of the Series 069 is only possible with a Receptacle.

The KS-069 is available pre-wired with 1 m Wire AWG 26 (see Ordering Example).

### Note:

Test Probes of the Series GKS-069 are also available with bent Barrel end (Special Designation „B“)

### Tools:

Insertion and Extraction Tools for GKS and KS see Page 118.

### Ordering Example

	Series	Tip Material 2 = Steel 3 = BeCu	Tip Style	Tip Diameter (1/100 mm)	Plating A = Gold N = Nickel	Spring Force (dN)	Collar Height (mm)	Special Designation („B“)
Test Probe:	G K S	0	6 9	3	0 6	0 9 0	A	0 7 0 0
Receptacles:	K S - 0 6 9 3 0	K S - 0 6 9 3 5	K S - 0 6 9 3 0 G					
Receptacle, pre-wired with AWG 26:	K S - 0 6 9 3 5 V - 2 6							

# GKS 079

Short-Stroke Test Probe

**Grid:**

≥ 1,27 mm

≥ 50 Mil

**Installation Height:** 3,2 mm (.126)

**Recommended Stroke:** 1,0 mm (.039)

## Mounting and Functional Dimensions

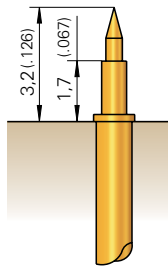
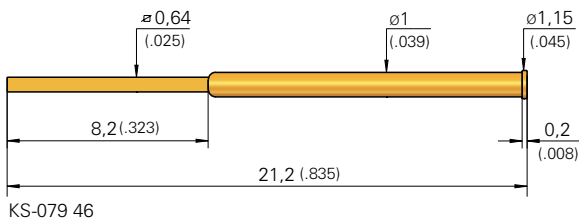
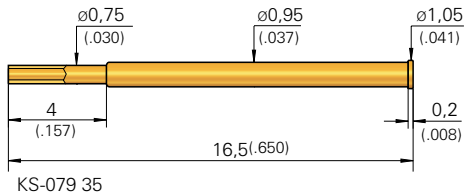
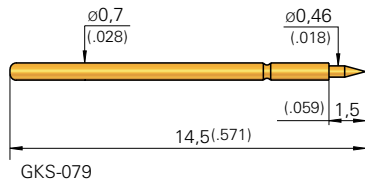

**Collar Height and Installation Height**

The Installation Height with KS-079 is:  
3,2 mm (.126)

## Available Tip Styles

Material	Tip Style	Plating	Further Versions	
			∅	∅ (inch)
ω 01		A	∅ 0,50 (.020)	

**Mechanical Data**

**Working Stroke:** 1,0 mm (.039)  
**Maximum Stroke:** 1,2 mm (.047)  
**Spring Force at Work. Stroke:** 1,3 N (4.7oz)

**Materials**

**Plunger:** BeCu, gold-plated  
**Barrel:** Bronze, gold-plated  
**Spring:** Steel, gold-plated  
**Receptacle:** Brass, gold-plated

**Electrical Data**

**Current Rating:** 3 A  
**R<sub>i</sub> typical:** < 20 mΩ

**Mounting Hole Size**

**KS-079 35**  
**in CEM 1 and FR 4:** ∅ 0,94 - 0,95 mm  
 (.0370 - .0374)  
**KS-079 46**  
**in CEM 1 and FR 4:** ∅ 0,99 - 1,00 mm  
 (.0390 - .0394)

**Note:**  
 The KS-079 is available pre-wired with  
 1 m Wire AWG 26  
 (see Ordering Example).

## Ordering Example

Series	Tip Material 3 = BeCu	Tip Style	Tip Diameter (1/100 mm)	Plating A = Gold	Spring Force (dN)	Collar Height (mm)
--------	--------------------------	-----------	----------------------------	---------------------	----------------------	-----------------------

Test Probe:	G	K	S	0	7	9	3	0	1	0	5	0	A	1	3	0	0
Receptacle:	K S - 0 7 9 3 5																
Receptacle with Wire-Wrap:	K S - 0 7 9 4 6																
Receptacle, pre-wired with AWG 26:	K S - 0 7 9 3 5 V - 2 6																

Grid:

≥ 1,27 mm

≥ 50 Mil

Installation Height: 10,5/13,0/16,0 mm (.413/ .512/ .630)

Recommended Stroke: 5,5 mm (.217)

## Mounting and Functional Dimensions

### without Receptacle

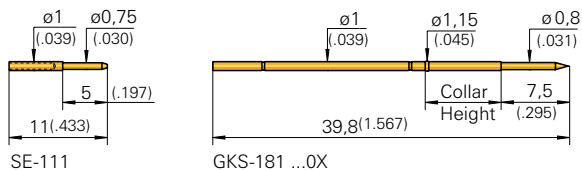

### with Receptacle

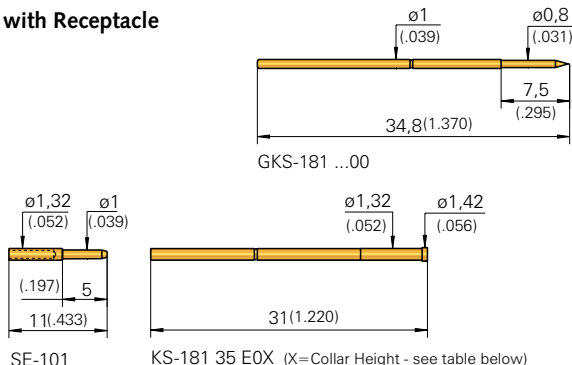

### Collar Height and Installation Height

To adjust the Installation Height of the Test Probes, Receptacles with various collar heights are available.

Collar Height	Installation Height
03	10,5 mm (.413)
05	13,0 mm (.512)
08	16,0 mm (.630)

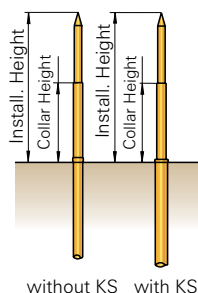

### Mechanical Data

**Working Stroke:** 5,5 mm (.217)  
**Maximum Stroke:** 7,5 mm (.295)  
**Spring Force at Work. Stroke:** 1,5 N (5.4oz)  
**alternative:** 0,8 N (2.9oz)

### Materials

**Plunger:** BeCu or Steel, gold-plated or chemically nickel-plated  
**Barrel:** Brass, gold-plated  
**Spring:** Steel, gold-plated  
**Receptacle:** Brass, gold-plated

### Note:

The Receptacle can be used from Grid 1,91 (75 Mil) up.

### Electrical Data

**Current Rating:** 2 - 3 A  
**R<sub>i</sub> typical:** < 20 mΩ

### Mounting Hole Size

**with Receptacle:** ø 1,31 - 1,32 mm (.0516 - .0520)  
**without Receptacle:** ø 1,00 mm (.0394)

### Tools:

Insertion and Extraction Tools for GKS and KS see Page 118.

## Ordering Example

Series	Tip Material 2 = Steel 3 = BeCu	Tip Style	Tip Diameter (1/100 mm)	Plating A = Gold N = Nickel	Spring Force (dN)	Collar Height (mm)
--------	---------------------------------------	-----------	----------------------------	-----------------------------------	----------------------	-----------------------

Test Probe for usage **without** Receptacle:

G K S 1 8 1 3 5 1 0 8 0 A 1 5 0 3

Test Probe for usage **with** Receptacle:

G K S 1 8 1 3 5 1 0 8 0 A 1 5 0 0

Receptacles:

K S - 1 8 1 3 5 E 03    K S - 1 8 1 3 5 E 05    K S - 1 8 1 3 5 E 08

Plug for Direct Connection on to GKS:

S E - 1 1 1

Plug for Receptacle:

S E - 1 0 1

### Available Tip Styles

Material	Tip Style	Plating	Further Versions	
			ø	ø (inch)
3 05		A	ø 0,80 (.031)	
3 51		A	ø 0,80 (.031)	
3 54		A	ø 0,80 (.031)	
2 91		N	ø 0,80 (.031)	





# Metric Standard Probes

As an enhancement of the classical ICT/FCT Test Probe without a collar, the standard metric Test Probes have a pre-defined collar and distinguish themselves with a high level of stability and sturdiness. Depending on the series, the collar is available with different heights and, in combination with the Receptacles, offers maximum flexibility of the installation height.

Apart from the classical applications, these series cover numerous special applications, e.g. Test Probes with continuous, through plungers, short- or long-stroke versions as well as battery charging probes.

# Metric Standard Probes (≥ 2,54 mm)

KS-112	50
GKS-112	51
VS-112	51
GKS-912	52
GKS-422	53
GKS-412	54
GKS-204/204 M	55
GKS-102	56
GKS-502	57
GKS-113	58
GKS-913	59
GKS-103/103 M	60
GKS-503/503 M	61
GKS-364	62
GKS-365	63
GKS-366	63
GKS-854	138

Screw-in Test Probes from page 125 on.

Metric Stand.

Solderable

Short-stroke

Flying Probes

DKS

SKS

PKS/PSK

RF/Dipole Test Probes

HSS

Fixture customizing

Tools

Cable Test Probes

Receptacles of the Series KS-112 are available with different Collar Heights. Variable Installation Heights are possible. \*The number of variations can be increased when using Spacers. However, it is then possible that the holding force of the Test Probe in the Receptacle could be reduced. In such cases, Test Probes with bent ends (End Designation „B“ = Banana) should be used. The Receptacles KS-112 47 (with wire-wrap-Post) are sufficiently vacuum-sealed for usage in vacuum fixtures.

Receptacles with Solder Terminal		
Order No.:	Receptacle Type	Collar Height in mm (inches)
KS-112 23		0,2 (.008)
KS-112 30		0,2 (.008)
KS-112 30 E2		2 (.079)
KS-112 30 E5		5 (.179)

Receptacles with Plug Connection		
KS-112 35 with SE-101		0,2 (.079)

Receptacles with Press-ring		
KS-112 30 G8		1 ... 8 (.039... .315)
KS-112 47 G8		8 (.039... .315)

Vacuum-sealed Receptacles with Wire-Wrap-Posts		
KS-112 47		0,2 (.008)
KS-112 47 15		0,2 (.008)
KS-112 47 E2/E5		2/5 (.079 / .197)

* Spacers to vary the installation Height				
DS-112-01	DS-112 01	DS-112 02	DS-112 03	DS-112 05

- Receptacles: **KS - 1 1 2 3 0**    **KS - 1 1 2 4 7**
- Spacers: **DS - 1 1 2 0 2**    **DS - 1 1 2 0 5**
- Insertion Tools for all Receptacles: **SW KS - 1 1 2**

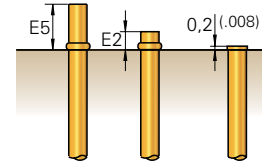

Example for usage of KS-112 with different Collar Heights

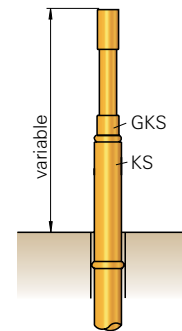

Example for usage of KS-112 ... G8 (with Press-ring)

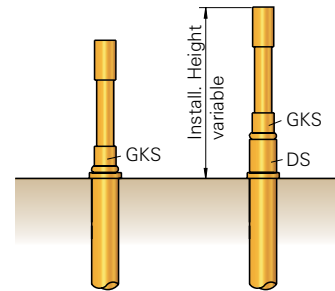

\* Example of usage of a Receptacle with and without Spacer (restrictions see above)

### Mounting Hole Size

for KS with Collar:

CEM 1:  $\varnothing$  1,98 - 2,00 mm (.0780 - .0787)

FR 4:  $\varnothing$  1,99 - 2,01 mm (.0783 - .0791)

### Material

for KS with Collar:

Brass or Nickel-silver, gold-plated

### Mounting Hole Size

for KS with Press-ring

(Press-ring pressed in die Mounting Hole)

CEM 1 and FR 4:  $\varnothing$  2,03 - 2,05 mm

(.0799 - .0807)

### Material

for KS with Press-ring:

Bronze, gold-plated

### Tools:

Insertion and Extraction Tools for GKS and KS see Page 118.

Grid:  
 ≥ 2,54 mm  
 ≥ 100 Mil

Installation Height: 10,3 - 18,3 mm (.406 - .720)  
 Recommended Stroke: 4,0 mm (.157)

### Mounting and Functional Dimensions

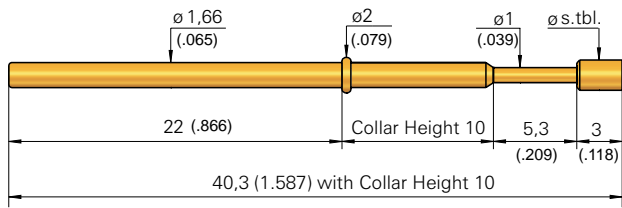

### Plug

**VS-112** is used instead of a Test Probe and prevents in case of maintenance, that not required Receptacles will accidentally be used.

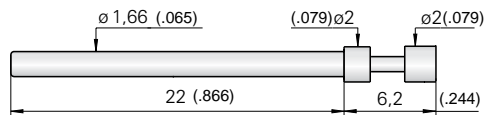

Solid „Probe“ made of Plastic

### Collar Height and Installation Height

To adjust the Installation Height off the Tip (Dimension without Receptacle) Test Probes with alternative Collar Heights are available.

Collar Height	Installation Height (without Receptacle)
02	10,3 mm (.406)
03	11,3 mm (.445)
04	12,3 mm (.484)
05	13,3 mm (.524)
06	14,3 mm (.563)
07	15,3 mm (.602)
08	16,3 mm (.642)
09	17,3 mm (.681)
10	18,3 mm (.720)

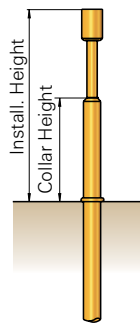

without KS

### Mechanical Data

**Working Stroke:** 4,0 mm (.157)  
**Maximum Stroke:** 5,3 mm (.209)  
**Spring Force at Work. Stroke:** 1,5 N (5.4oz)  
**alternative:** 0,6 N (2.2oz); 0,8 N (2.9oz); 2,25 N (8.1oz); 3,0 N (10.8oz); 5,0 N (18.1oz)

Test Probes with Tip Diameter ≤ 1,0 mm (.039) have a maximum Working Stroke of 8,0 mm (.315)

Exception: 5,0 N-Spring (18.1oz): max. Stroke is always 5,3 mm (.209).

### Materials

**Plunger:** BeCu or Steel, gold-plated, rhodium- or chemically nickel-plated  
**Barrel:** Nickel-Silver or Brass, gold-plated  
**Spring:** Steel, gold-plated, Stainless Steel\*(C)  
**Receptacle:** Brass, gold-plated

### Operating Temperature

**Standard:** -40° up to +80° C  
**\*with spec. Designation "C":** -100° up to +200° C (0,8 N ; 1,5 N; 2,25 N; 3,0 N)

### Electrical Data

**Current Rating:** 5 - 8 A  
**R<sub>i</sub> typical:** < 20 mΩ (\* < 100 mΩ)

### Available Tip Styles

Material	Tip Style	Plating	Further Versions	
			∅	∅ (inch)
2	01	R A	0,80	(.031)
3	02	A		
3	02	A	1,00 1,50	(.039) (.059)
3	03	A	1,40 1,80	(.055) (.071)
2	04	R	1,30	(.051)
3	05	A	0,80	(.031)
3	05	A	1,00 1,40 2,30	(.039) (.055) (.091)
0	06**	A		
3	06	A		
3	06	R	1,30 R 1,50 R 1,80 R 2,50 R	(.051) (.059) (.071) (.098)
2	07	R A	1,30 A	(.051)
2	09***	N		
2	14	A	1,30 R	(.051)
2	17	N		
3	19	A	2,00 A	(.079)

\*\* also available as Tip Style 0 02 and 0 03, Installation Height plus 0,8 mm (.031)

\*\*\* pressed-in Steel point in Base Plunger made of Brass

**Note to GKS-112 and KS-112:**  
 For the Test Probes series GKS-112 Receptacles of the series KS-112 are used (see Page 50).

**Note:**  
 Screw-in Versions see Page 132.

**Tools:**  
 Insertion and Extraction Tools for GKS and KS see Page 118.

### Ordering Example

Series	Tip Material	Tip Style	Tip Diameter (1/100 mm)	Plating	Spring Force (dN)	Collar Height (mm)	Special Designation („B“, „C“)
0 = Delrin	2 = Steel	3 = BeCu	A = Gold	N = Nickel	R = Rhodium		

Test Probe:

G K S 1 1 2 2 0 4 1 3 0 R 1 5 0 2

Receptacle for GKS-112:

K S - 1 1 2 3 0 K S - 1 1 2 4 7

Plug:

V S - 1 1 2

e-type® Probes  
 ICT / FCT  
 Bead Probes  
 Fine Pitch  
 Metric Stand.  
 Solderable  
 Short-stroke  
 Flying Probes  
 DKS  
 SKS  
 PK5 / PSK  
 RF / Dipole Test Probes  
 HSS  
 Fixture customizing  
 Tools  
 Cable Test Probes

# GKS 912

ICT-/FCT Test Probe

**Width:**

≥ 2,54 mm

≥ 100 Mil

**Installation Height:** 10,0 - 18,0 mm (.394 - .709)

**Recommended Stroke:** 4,0 mm (.157)

## Mounting and Functional Dimensions

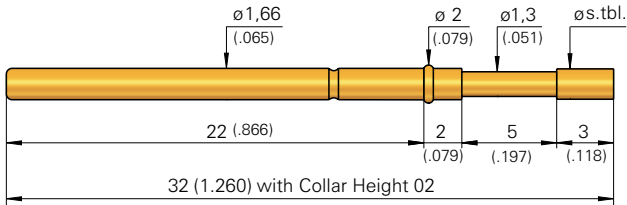

### Collar Height and Installation Height

To adjust the Installation Height off the Tip (Dimension without Receptacle) use Test Probes with alternative Collar Heights.

Collar Height	Installation Height (without Receptacle)
02	10,0 mm (.394)
03	11,0 mm (.433)
04	12,0 mm (.472)
05	13,0 mm (.512)
06	14,0 mm (.551)
07	15,0 mm (.591)
10	18,0 mm (.709)

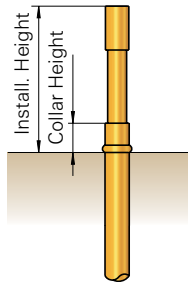

(\*\*Tip Style 00x: Install. Height is 0,8 mm (.031) higher)

### Mechanical Data

**Working Stroke:** 4,0 mm (.157)  
**Maximum Stroke:** 5,0 mm (.197)  
**Spring Force at Work. Stroke:** 1,5 N (5.4oz)  
**alternative:** 0,6 N (2.2oz); 0,8 N (2.9oz); 2,25 N (8.1oz); 3,0 N (10.8oz); 5,0 N (18.1)

### Electrical Data

**Current Rating:** 5 - 8 A  
**R<sub>i</sub> typical:** < 20 mΩ (\* < 100 mΩ)

### Materials

**Plunger:** BeCu or Steel, gold-plated, rhodium- or chemically nickel-plated  
**Barrel:** Nickel-Silver or Brass, gold-plated  
**Spring:** Steel, gold-plated or Stainless Steel\* (C)

### Operating Temperature

**Standard:** -40° bis +80° C  
**\*with Spec. Designation "C":** -100° up to +200° C (0,8 ; 1,5; 2,25; 3,0 N)

### Note:

For Test Probes series GKS-912 Receptacles of the series KS-112 are used (see Page 50).

### Tools:

Insertion and Extraction Tools for GKS and KS see Page 118.

## Available Tip Styles

Material	Tip Style	Plating	Further Versions	
			∅	∅ (inch)
2	01	A	0,60 R 0,80 R 1,00 R	(.024) (.031) (.039)
3	02	A	2,50	(.098)
3	03	A	1,80 2,50 3,50	(.071) (.098) (.138)
2	04	A	1,30 2,00 R	(.051) (.079)
3	05	A	0,70 1,40 1,50	(.028) (.055) (.059)
0	06**	A	0,8 ∅ 2,30	(.031) (.091)
2	06	R	∅ 1,50	(.059)
3	06	A	1,40 A	(.055)
3	06	R	1,80 2,50 3,50	(.071) (.098) (.138)
2	07	A R	1,30 A 1,50 A 1,80 A 2,50 A	(.051) (.059) (.071) (.098)
2	09***	N	0,70 A 0,80 A	(.028) (.031)
2	14	A	1,30 R	(.051)
2	15***	A	1,30 R	(.051)
2	17	N	1,30 A	(.051)
2	24	R	1,30 A	(.051)
2	31	R	∅ 1,80	(.071)
2	33	N	∅ 1,30	(.051)
2	88	A	∅ 2,30	(.091)
2	91	A	∅ 1,30 1,30 G	(.051) (.051)
2	93	A	∅ 1,60	(.063)

\*\* also available as Tip Style 002 or 003

\*\*\* pressed-in Steel Tip in Base Plunger of Brass

## Ordering Example

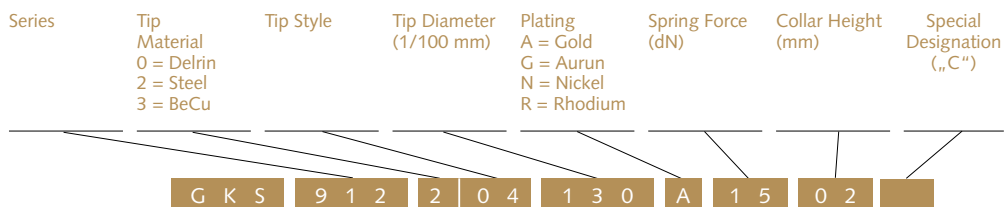

Grid:  
 ≥ 2,54 mm  
 ≥ 100 Mil

Installation Height: 16,0 mm (.630)  
 Recommended Stroke: 6,4 mm (.252)

## Mounting and Functional Dimensions

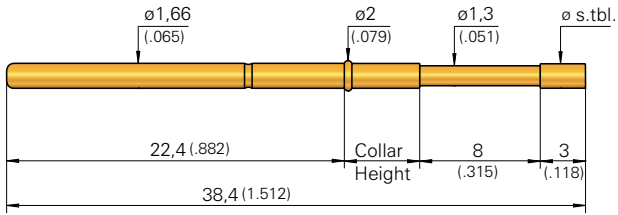

### Collar Height and Installation Height

The Test Probes are always supplied with a Collar Height of 5 mm (.197).

The Test Probes with Tip Style 01 and 09 have a Collar Height of 8 mm (.315) - this to ensure stability of the plunger shaft.

Collar Height	Installation Height (without Receptacles)
05	16 mm (.630)
08	16 mm (.630)
(** Tip Styles 00x: Install. Height 16,8 mm (.661))	

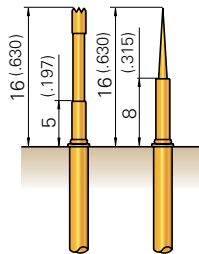

### Mechanical Data

**Working Stroke:** 6,4 mm (.252)  
**Maximum Stroke:** 8,0 mm (.315)  
**Spring Force at Work. Stroke:** 1,5 N (5.4oz)  
**alternative:** 0,8 N (2.9oz); 2,25 N (8.1oz); 3,0 N (10.8oz); 5,0 N (18.1oz)

### Materials

**Plunger:** BeCu or Steel, gold-plated rhodium- or chemically nickel-plated  
**Barrel:** Bronze, gold-plated  
**Spring:** Steel, gold-plated or Stainless Steel\* (C)

### Electrical Data

**Current Rating:** 5 - 8 A  
**R<sub>i</sub> typical:** < 20 mΩ (\* < 100 mΩ)

### Operating Temperature

**Standard:** -40° up to +80° C  
**\*with Spec. Designation "C":** -100° up to +200° C (1,5 N; 3,0 N)

## Available Tip Styles

Material	Tip Style	Plating	Further Versions	
			∅	∅ (inch)
2	01	A	∅ 1,30 (.051)	1,30 R (.051)
3	02	A	∅ 2,00 (.079)	
2	04	A	∅ 1,30 (.051)	
3	05	A	∅ 1,30 (.051)	0,70 (.028)
0	06**	A	∅ 2,30 (.091)	
3	06	A	∅ 2,00 (.079)	1,30 (.051) 1,60 (.063)
3	07	A	∅ 1,30 (.051)	
2	09***	N	∅ 0,80 (.031)	0,80 A/G (.031) 0,60 A/N (.024)
2	14	A	∅ 1,30 (.051)	0,60 (.024) 2,00 (.079)
2	17	A	∅ 1,80 (.071)	
2	24**	A	∅ 1,80 (.071)	
2	33	N	∅ 1,30 (.051)	1,30 A (.051)
2	91	N	∅ 1,30 (.051)	0,80 N (.031) 1,30 A/G (.051)
2	93	A	∅ 1,60 (.063)	

\*\* also available as Tip Style 0 02

\*\*\* pressed-in Steel Tip in Base Plunger made of Brass

\*\*\*\* higher middle tip plus 0,5 mm

### Note:

For Test Probes series GKS-422 Receptacles of the series KS-112 are used (see Page 50).

### Tools:

Insertion and Extraction Tools for GKS and KS see Page 118.

## Ordering Example

Series	Tip Material	Tip Style	Tip Diameter (1/100 mm)	Plating	Spring Force (dN)	Collar Height (mm)	Special Designation („C“)
G K S	0 = Delrin 2 = Steel 3 = BeCu	4 2 2	2	A = Gold G = Aurum N = Nickel R = Rhodium	1 5	0 5	
Receptacle:	K S - 1 1 2 4 7						

e-type® Probes  
 ICT / FCT  
 Bead Probes  
 Fine Pitch  
 Metric Stand.  
 Solderable  
 Short-stroke  
 Flying Probes  
 DKS  
 SKS  
 PKS / PSK  
 RF / Dipole Test Probes  
 HSS  
 Fixture customizing  
 Tools  
 Cable Test Probes



# GKS 412

Long-stroke Test Probe for Dual-stage Fixture

**Grid:**

≥ 2,54 mm

≥ 100 Mil

**Installation Height:** 14,8 - 22,8 mm (.583 - .898)

**Recommended Stroke:** 8,0 mm (.315)

## Mounting and Functional Dimensions

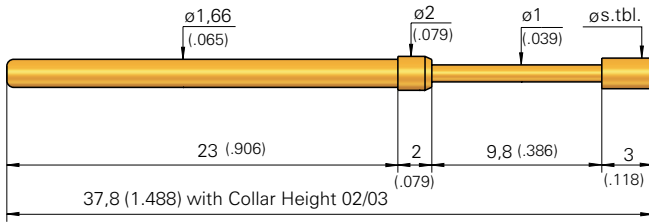

### Collar Height and Installation Height

To adjust the Installation Height of the Tip (Dimension without Receptacle), Test Probes with various Collar Heights are available.

Collar Height	Total Length	Installation Height (without KS)
02	37,8 mm (1.488)	14,8 mm (.583)
03	37,8 mm (1.488)	15,8 mm (.622)
05	40,2 mm (1.583)	17,8 mm (.701)
07	41,8 mm (1.646)	19,8 mm (.780)
10	44,8 mm (1.764)	22,8 mm (.898)

(\* Tip Style 00x: Install. Height is 0,8 mm (.315) higher)

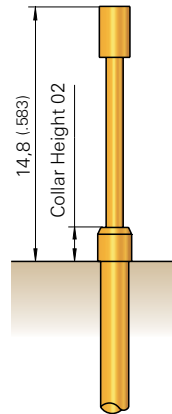

## Available Tip Styles

Material	Tip Style	Plating	Further Versions	
			∅	∅ (inch)
2	01	R	∅ 1,00 (.039)	
3	03	A	∅ 1,80 (.071)	2,00 A (.079)
0	03*	A	∅ 2,30 (.091)	
2	04	R	∅ 1,30 (.051)	
2	06	R	∅ 1,30 (.051)	2,00 R (.079) <b>NEW</b>
3	07	R	∅ 1,30 (.051)	
2	09**	N	∅ 0,70 (.028)	
2	14	A	∅ 1,30 (.051)	
2	17	A	∅ 2,00 (.079)	
2	24	R	∅ 2,00 (.079)	
2	25	R	∅ 1,50 (.059)	
2	88	A	∅ 1,80 (.071)	
2	91	A	∅ 1,30 (.051)	

\*\* pressed-in Steel Tip in Base Plunger made of Brass

### Mechanical Data

**Working Stroke:** 8,0 mm (.315)  
**Maximum Stroke:** 9,8 mm (.386)  
**Spring Force at Work. Stroke:** 1,5 N (5.4oz)  
**alternative:** 0,6 N (2.2oz); 3,0 N (10.8oz); 5,0 N (18.1oz)

### Materials

**Plunger:** BeCu or Steel, gold-plated, rhodium- or chemically nickel-plated  
**Barrel:** Brass or Nickel-Silver, gold-plated  
**Spring:** Steel, gold-plated

### Note:

For Test Probes series GKS-412 Receptacles of the series KS-112 are used (see Page 50).

### Tools:

Insertion and Extraction Tools for GKS and KS see Page 118.

### Electrical Data

**Current Rating:** 5 - 8 A  
**R<sub>i</sub> typical:** < 20 mΩ

## Ordering Example

Series	Tip Material	Tip Style	Tip Diameter (1/100 mm)	Plating	Spring Force (dN)	Collar Height (mm)
	0 = Delrin 2 = Steel 3 = BeCu			A = Gold R = Rhodium N = Nickel		

Test Probe:

G K S 4 1 2 2 0 4 1 3 0 A 1 5 0 2

Receptacle:

K S - 1 1 2 4 7

**Grid:**  
 ≥ 2,54 mm  
 ≥ 100 Mil

**Installation Height:** 16/18/23 mm (.630/ .709/ .906)  
**Recommended Stroke:** 8,0 mm (.315)

### Mounting and Functional Dimensions

#### GKS-204

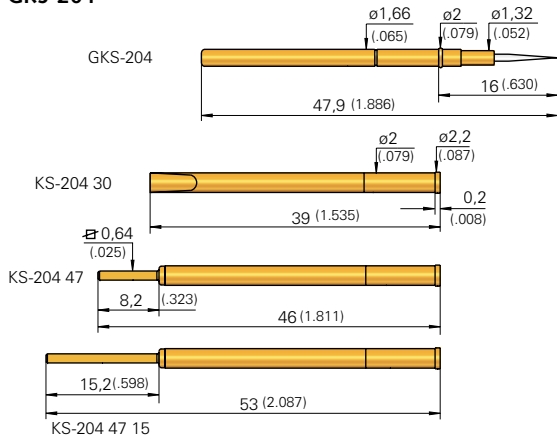

#### GKS-204 ... M

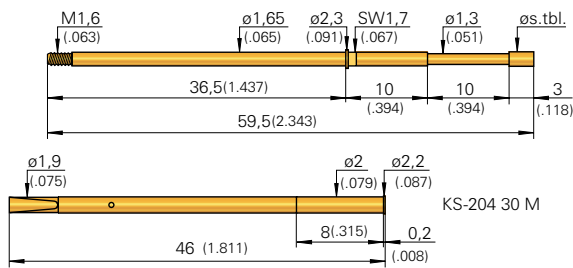

#### Collar Height and Installation Height

To adjust the Installation Height of the Tip (dimension without Receptacle), use Test Probes with alternative Collar Heights.

Collar Height	Installation Height (without Receptacle)
03	16,0 mm (.630)
05	18,0 mm (.709)
10	23,0 mm (.906)
10 M (with KS)	23,0 mm (.906)

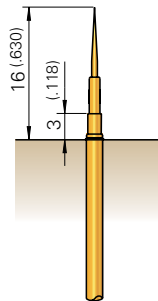

#### Mechanical Data

**Working Stroke:** 8,0 mm (.315)  
**Maximum Stroke:** 10,0 mm (.394)  
**Spring Force at Work. Stroke:** 1,5 N (5.4oz)  
**alternative:** 0,8 N (2.9oz); 3,0 N (10.8oz)

#### Electrical Data

**Current Rating:** 5 - 8 A  
**R<sub>i</sub> typical:** < 20 mΩ

#### Materials

**Plunger:** BeCu or Steel, gold-plated, rhodium- or chemically nickel-plated  
**Barrel:** Nickel-Silver or Brass, gold-plated  
**Spring:** Steel, gold-plated  
**Receptacle:** Brass, gold-plated

#### Mounting Hole Size

**KS-112, see Page 50**  
**for KS-204 30 M:** ∅ 1,99 mm (.0783)

### Available Tip Styles

Material	Tip Style	Plating	Further Versions	
			∅	∅ (inch)
2 01		R	∅ 1,30 (.051)	
3 02		A	∅ 1,80 (.071)	
3 03		A	∅ 1,80 (.071)	
2 04		A	∅ 1,30 (.051)	
3 05		A	∅ 1,30 (.051)	
2 06		R	∅ 1,80 (.071)	
2 07		A	∅ 1,30 (.051)	
2 09*		N	∅ 0,70 (.028)	0,70 G (.028)
2 14		A	∅ 1,30 (.051)	
2 15*		A	∅ 1,80 (.071)	
2 24		R	∅ 2,00 (.079)	
2 91		N	∅ 1,30 (.051)	1,30 (.051)
2 93		A	∅ 1,60 (.063)	

\* pressed-in Steel Tip in Base Plunger made of Brass

#### Note:

GKS-204 ... M will be screwed into Receptacle KS-204 30 M using special Tools (see Page 170).

**Recommended Screw-in Torque:**  
 Min.: 3 Ncm / Max.: 5 Ncm

#### Tools:

Insertion and Extraction Tools for GKS and KS see Page 118.

### Ordering Example

Series	Tip Material	Tip Style	Tip Diameter (1/100 mm)	Plating	Spring Force (dN)	Collar Height (mm)	Type (alternative "M")
G K S	2 = Steel 3 = BeCu			A = Gold R = Rhodium N = Nickel			
2 0 4							
2 0 4							
1 3 0							
A							
1 5							
0 3							
KS-204 47							
KS-204 47 15							
KS-204 30							
KS-204 30 M							

Test Probe:

Receptacles:

Receptacle for Screw-in Version:

# GKS 102

Universal Test Probe for direct Wiring

## Grid:

≥ 2,54 mm

≥ 100 Mil

Installation Height: 12,5 resp. 13,5 mm (.492/ .531)

Recommended Stroke: 4,8 mm (.189)

## Mounting and Functional Dimensions

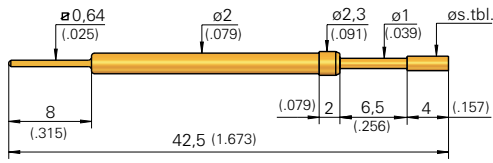

GKS-102 ... W

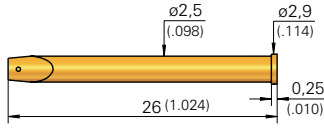

KS-102 23

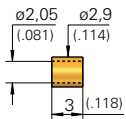

DS-102 03

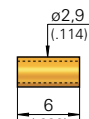

DS-102 06

## GKS-102 250 400 P xx02 W

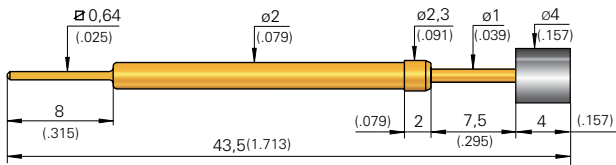

## Available Tip Styles

Material	Tip Style	Plating	Further Versions	
			∅	∅ (inch)
2	01	A	∅ 1,00 (.039)	
1	02	A	∅ 1,40 (.055)	2,30 (.091)
1	03	A	∅ 1,40 (.055)	
2	04	A	∅ 1,40 (.055)	
1	05	A	∅ 1,40 (.055)	
2	06	A	∅ 1,40 (.055)	
2	50*	P	∅ 4,00 (.157)	

\* PCB Support Probe: insulating Tip made of PVC  
Installation Height 13,5 mm (.531)

## Collar Height and Installation Height

The Installation Height of the Tip (Dimension without Receptacle) is defined by the Collar Height.

Collar Height	Installation Height (without Receptacle)
02 Tip Style 01 up to 06	12,5 mm (.492)
02 Tip Style 50*	13,5 mm (.531)

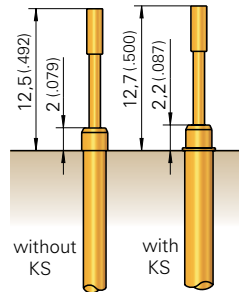

## Mechanical Data

**Working Stroke:** 4,8 mm (.189)  
**Maximum Stroke:** 6,5 mm (.256)  
**Spring Force at Work. Stroke:** 1,5 N (5.4oz)  
**alternative:** 3,0 N (10.8oz); 5,0 N (18.1oz)

## Electrical Data

**Current Rating:** 5 - 8 A  
**R<sub>i</sub> typical:** < 20 mΩ

## Materials

**Plunger:** Brass or Steel, gold-plated  
**Barrel:** Brass, gold-plated  
**Spring:** Steel, gold-plated  
**Receptacle:** Brass, gold-plated

## Mounting Hole Size

**with Receptacle:** ∅ 2,48 - 2,49 mm (.0976 - .0980)  
**without Receptacle:** ∅ 2,00 mm (.0787)

## Note:

The Receptacle can be used from Grid 3,50 mm (140 Mil) up.

## Tools:

Insertion and Extraction Tools for GKS and KS see Page 118.

## Ordering Example

Series	Tip Material 1 = Brass 2 = Steel	Tip Style	Tip Diameter (1/100 mm)	Plating A = Gold P = PVC	Spring Force (dN)	Collar Height (mm)	Type
--------	--	-----------	----------------------------	--------------------------------	----------------------	-----------------------	------

Test Probe:

G K S 1 0 2 1 0 2 1 4 0 A 1 5 0 2 W

Receptacle:

K S - 1 0 2 2 3

Spacers:

D S - 1 0 2 0 3      D S - 1 0 2 0 6

**Grid:**  
 ≥ 2,54 mm  
 ≥ 100 Mil

**Installation Height:** 12,0 resp. 13,0 mm (.472/ .512)  
**Recommended Stroke:** 5,6 mm (.220)

## Mounting and Functional Dimensions

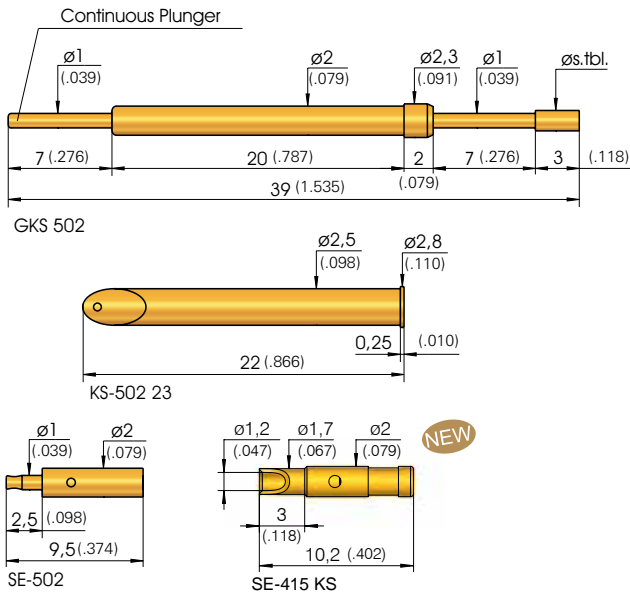

## Available Tip Styles

Material	Tip Style	Plating	Further Versions	
			Ø	Ø (inch)
3 02		A	Ø 1,40 (.055)	
3 03		A	Ø 1,80 (.071)	
3 04		A	Ø 1,40 (.055)	
2 33 ***		R	Ø 2,50 (.098)	
3 53 **		A	Ø 2,50 (.098)	
3 56 **		A	Ø 2,50 (.098)	2,50 R (.098)

\*\* Tip Length 4 mm (.157)  
 \*\*\* Tip Length 4 mm (.157), Special Designation "L"

### Collar Height and Installation Height

The Installation Height of the Tip (Dimension without Receptacle) is defined by the Collar Height.

Collar Height	Tip Style	Install. Height (without KS)
02	04 / 03 / 02	12,0 mm (.472)
02	56 / 53 / 33	13,0 mm (.512)

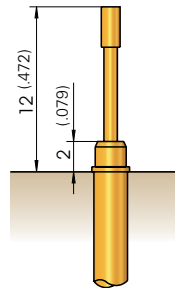

### Mechanical Data

**Working Stroke:** 5,6 mm (.220)  
**Maximum Stroke:** 7,0 mm (.276)  
**Spring Force at Work. Stroke:** 1,5 N (5.4oz)  
**alternative:** 0,8 N (2.9oz); 3,5 N (12.5oz); 5,0 N (18.1oz)

### Electrical Data

**Current Rating, Conn. to Plunger:** 12-15 A  
**Current Rating, Connection to KS:** 5 - 8 A  
**R<sub>i</sub> typical, Connection to Plunger:** < 10 mΩ  
**R<sub>i</sub> typical, Connection to KS:** < 30 mΩ (\* < 100 mΩ)

### Materials

**Plunger:** BeCu or Steel  
 gold- or rhodium-plated  
**Barrel:** Brass, gold-plated  
**Spring:** Steel, gold-plated or Stainless Steel\*  
**Receptacle:** Brass, gold-plated

### Mounting Hole Size

**in CEM 1 and FR 4:**  
**with Receptacle:** Ø 2,48 - 2,49 mm (.0976 - .0980)  
**without Receptacle:** Ø 2,00 mm (.0787)

### Note:

The Receptacle can be used from Grid 3,50 mm (140 Mil) up.

### Tools:

Insertion and Extraction Tools for GKS and KS see Page 118.

### Operating Temperature

**Standard:** -40° up to +80° C  
**\*with 5,0 N-Spring:** -100° up to +200° C

## Ordering Example

	Series	Tip Material 2 = Steel 3 = BeCu	Tip Style	Tip Diameter (1/100 mm)	Plating A = Gold R = Rhodium	Spring Force (dN)	Collar Height (mm)	Special Designation „L“
Test Probe:	G K S	3	02	140	A	15	02	
Receptacle:	K S - 502 23							
Plug:	S E - 502		S E - 415 K S		(for plugging onto the end of the Plunger)			

# GKS 113

Test Probe

**Grid:**

≥ 4,00 mm

≥ 160 Mil

**Installation Height:** 10,5/13,5/18,5 mm (.413/ .531/ .728)

**Recommended Stroke:** 4,0 mm (.157)

## Mounting and Functional Dimensions

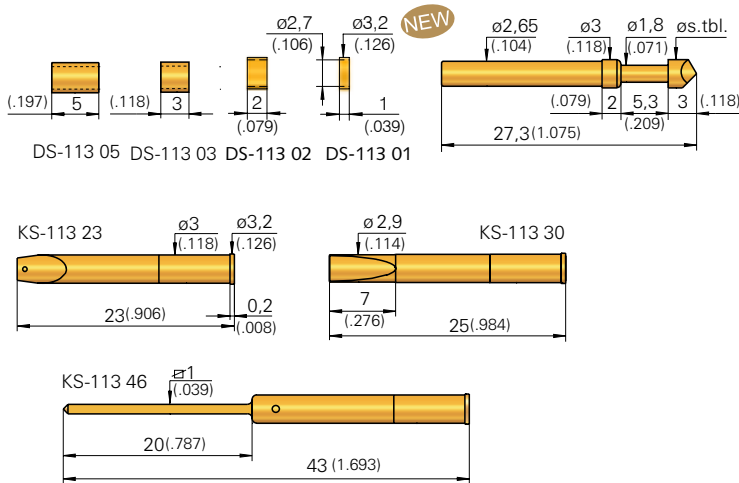

### Collar Height and Installation Height

The Installation Height of the Tip (dimension measured with Receptacle) is defined by the Collar Height.

Collar Height	Installation Height (with Receptacle)
02	10,5 mm (.413)
05	13,5 mm (.531)
10	18,5 mm (.728)

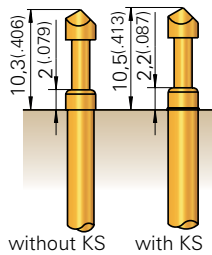

### Mechanical Data

**Working Stroke:** 4,0 mm (.157)  
**Maximum Stroke:** 5,3 mm (.209)  
**Spring Force at Work. Stroke:** 1,5 N (5.4oz)  
**alternative:** 0,3 (1.1oz); 0,6 (2.2oz); 1,0 (3.6oz); 2,25 (8.1oz); 3,0 (10.8oz); 5,0 N (18.1oz)

### Electrical Data

**Current Rating:** 5 - 8 A  
**R<sub>i</sub> typical:** < 30 mΩ (\* < 100 mΩ)

### Operating Temperature

**Standard:** -40° up to +80° C  
**\*with Spec. Designations "C":** -100° up to +200° C (1,5 N; 2,25 N; 3,0 N)

### Materials

**Plunger:** BeCu or Steel, gold-, rhodium- or chemically nickel-plated  
**Barrel:** Brass, gold-plated  
**Spring:** Steel, gold-plated or Stainless Steel\*(C)  
**Receptacles:** Brass, gold-plated

### Mounting Hole Size

**for GKS-113 and KS-113:**  
**with Receptacle:** ø 2,98 - 2,99 mm (.1173 - .1177)  
**without Receptacle:** ø 2,65 mm (.1043)

**Note:**

For Test Probes Series GKS-113 Receptacles of the series KS-113 are used. Screw-in Versions see Page 135.

## Available Tip Styles

Material	Tip Style	Plating	Further Versions	
			ø	ø (inch)
2	01	R		
3	02	A	0,80 1,00 1,80 3,00 4,00	(.031) (.039) (.071) (.118) (.157)
2	03	A		
3	03	A	4,00 R	(.157)
2	04	R	1,80 A 3,00	(.071) (.118)
3	05	A	0,80 1,40 3,00 R	(.031) (.055) (.118)
3	55	R		
Tip Length 4 mm (.157)				
3	06	A	1,60 2,30 4,00 8,00	(.063) (.091) (.157) (.315)
3	06	R	2,50 3,50 6,00	(.098) (.138) (.236)
2	07	A	4,20 R	(.165)
3	12	A		
3	13	R		
2	14	R		
2	15**	A		
Tip Length 5,5 mm				
2	17	R	1,80 3,00 A	(.071) (.118)
3	19	A	3,00	(.118)
3	72	A		
2	87	N	4,00	(.157)
2	88	A		

\*\* pressed-in Steel Tip in Base Plunger made of Brass

**Tools:**

Insertion and Extraction Tools for GKS and KS see Page 118.

## Ordering Example

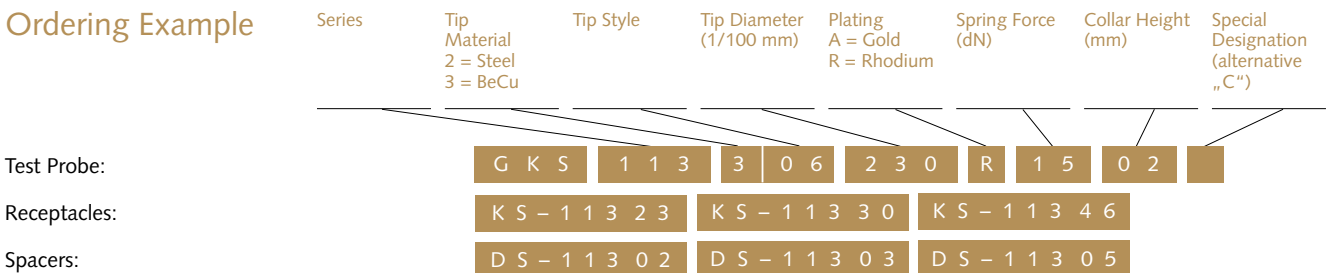

Grid:  
 ≥ 4,00 mm  
 ≥ 160 Mil

Installation Height: 7,2 / 8,7 mm (.283/ .343)  
 Recommended Stroke: 2,8 mm (.110)

## Mounting and Functional Dimensions

### GKS-913

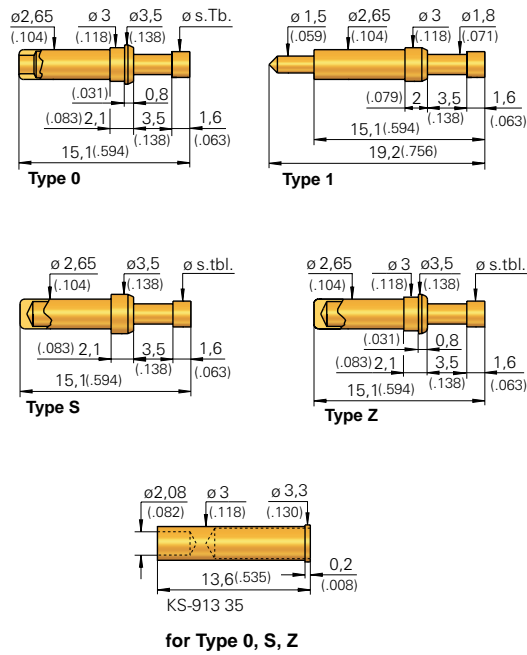

## Available Tip Styles

Material	Tip Style	Plating	Further Versions	
			$\phi$	$\phi$ (inch)
1 02		A	3,50	(.138)
3 03		A		
3 05		A		
3 06*		A		
3 06		A	3,50 R 2,30 R	(.138) (.091)
3 08		R		
3 58**		R		

Tip Length: 3,4 mm (.134)

### Collar Height and Installation Height

The Installation Height of the Tip is defined by the Collar Height.

Collar Height	Tip Style	Install. Height (without KS) in mm	max. Stroke mm
02	02/05/06/08	7,2 (.283)	3,5 (.138)
02	06 180*	7,2 (.283)	3,2 (.126)
02	58**	8,7 (.343)	3,3 (.130)

### Mechanical Data

**Working Stroke:** 2,8 mm (.110)  
**Maximum Stroke:** see table on the right  
**Spring Force at Work. Stroke:** 1,5 N (5.4oz)  
**alternative:** 0,8 N (2.9oz); 2,5 N (9.0oz)

### Materials

**Plunger:** Brass or BeCu, gold- or rhodium-plated  
**Barrel:** Brass, gold-plated  
**Spring:** Steel, gold-plated or Stainless Steel \*\*\*\* (C)  
**Receptacle:** Brass, gold-plated

### Electrical Data

**Current Rating:** 5 - 8 A (24 A\*\*\*\*)  
**R<sub>j</sub> typical:** < 20 m $\Omega$  (\*\*\*\* < 100 m $\Omega$ )

### Mounting Hole Size

**in Materials CEM 1 and FR 4:**  
**with Receptacle:**  $\phi$  2,98 - 2,99 mm (.1173 - .1177)  
**without Receptacle:**  $\phi$  2,65 mm (.1043)

### Operating Temperature

**Standard:** -40° up to +80° C  
**\*\*\* with Spec. Designation "C":** -100° up to +200° C (1,5 N)

### Note:

Typ	Version
0	End of Probe Barrel open
1	End of Probe Barrel with solder terminal
S	End of Probe Barrel closed; can be soldered into PCB
Z	End of Probe Barrel closed; can be soldered into PCB

Warning: Soldering the Probes demands great care. High temperatures must not reach the inside of the barrel, because this could destroy the spring.

The Receptacle KS-913 35 can only be combined with the Probe Types 0, S and Z.

\*\*\*\* For applications up to 24 A: HSS-520 (see Page 106).

Screw-in Versions see Page 142.

### Tools:

Insertion and Extraction Tools for GKS and KS see Page 118.

## Ordering Example

Series	Tip Material	Tip Style	Tip Diameter (1/100 mm)	Plating	Spring Force (dN)	Collar Height (mm)	Type
	1 = Brass 3 = BeCu			A = Gold			1, 0, S, Z, 1C, 0C, SC, ZC

Test Probe:

G K S 9 1 3 3 0 8 2 3 0 R 1 5 0 2 0

Receptacles:

K S - 9 1 3 3 5



# GKS 103 / 103 M

Universal Test Probe with high stability

## Grid:

≥ 4,00 mm

≥ 160 Mil

Installation Height: 12,3 mm (.484)

Recommended Stroke: 4,8 mm (.189)

## Mounting and Functional Dimensions

### GKS-103 Type „W“

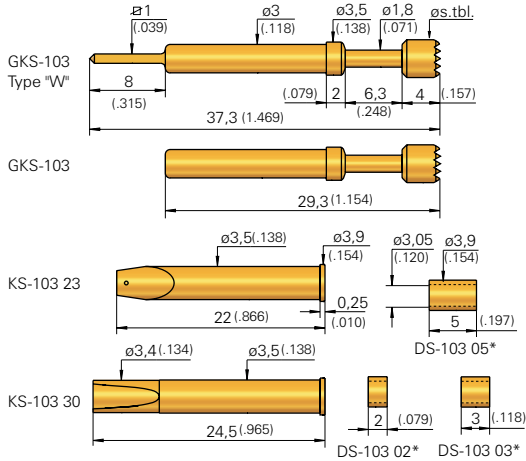

#### Note:

The Receptacle KS-103 30 is not compatible with GKS-103 Typ „W“.

### GKS-103 ... M

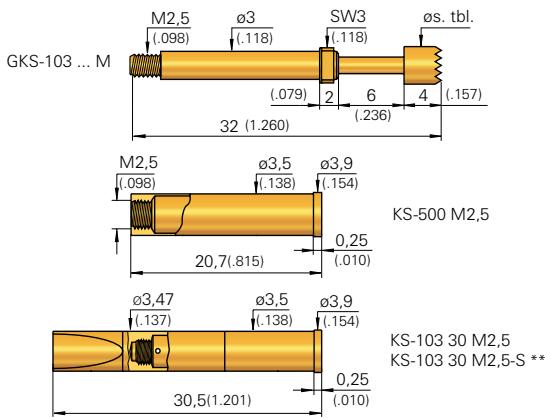

### Collar Height and Installation Height

The Installation Height of the Tip is determined by the Collar Height.

Collar Height	Installation Height (without Receptacle)
02	12,3 mm (.484)

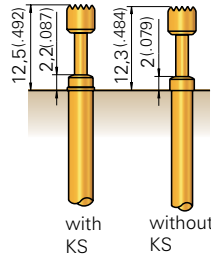

### Mechanical Data

**Working Stroke:** 4,8 mm (.189)  
**Maximum Stroke:** 6,0 mm (.236)  
**Spring Force at Work. Stroke:** 1,5 N (5.4oz)  
**alternative:** 0,8 N (2.9oz); 3,0 N (10.8oz), 5,0 N (18.1oz)

### Materials

**Plunger:** Steel or Brass, gold-plated  
**Barrel:** Brass, gold-plated  
**Spring:** Steel, gold-plated or Stainless Steel\*\*\* (C)  
**Receptacle:** Brass, gold-plated

### Electrical Data

**Current Rating:** 5 - 8 A  
**R<sub>i</sub> typical:** < 30 mΩ (\*\*\* < 100 mΩ)

### Mounting Hole Size

**with Receptacle:** Ø 3,48 - 3,49 mm (.1370 - .1374)  
**without Receptacle:** Ø 3,00 mm (.1181)

### Operating Temperature

**Standard:** -40° bis +80° C  
**\*\*\* with Spec. Designation "C":** -100° up to +200° C (1,5 N; 3,0 N; 5,0 N)

## Available Tip Styles

Material	Tip Style	Plating	Further Versions	
			Ø	Ø (inch)
2	01	A	Ø 1,80 (.071)	
1	02	A	Ø 2,30 (.091)	4,00 (.157)
2	02	A	Ø 6,50 (.256)	
1	03	A	Ø 2,30 (.091)	4,00 (.157)
2	04	A	Ø 2,30 (.091)	4,00 (.157)
1	05	A	Ø 2,30 (.091)	4,00 (.157)
2	06	A	Ø 2,30 (.091)	4,00 (.157) 6,50 (.256) 9,00 (.354)

#### \* Note:

The Receptacle can be used from Grid 4,50 mm (177 Mil) up.

- Usage of Spacers is not possible with GKS-103 ... M.
- Usage of the Test Probe with Spacer DS-103 03 and DS-103 05 is only possible with KS-103 23-2 (i.e. Receptacle with stronger crimp in upper crimp position.)

#### \*\* KS-103 30 M2,5-S:

The Test Probes is secured in the Receptacle by means of a crimp.

#### Note:

GKS-103 ... M will be screwed into Receptacle KS-500 M2,5; using special tools (see Page 170/171).

Test Probes with Tip Diameter > 4,0 mm (.157) cannot be assembled with this tool. Tool upon request

Recommended Screw-in Torque: Min.: 10 Ncm / Max.: 20 Ncm

## Ordering Example

Series	Tip Material	Tip Style	Tip Diameter (1/100 mm)	Plating	Spring Force (dN)	Collar Height (mm)	Type alternative „W“
	1 = Brass 2 = Steel			A = Gold			„M“, „C“, „WC“, „MC“

Test Probe:

G K S 1 0 3 2 0 1 1 8 0 A 1 5 0 2

Receptacles:

K S - 1 0 3 2 3 K S - 1 0 3 3 0

Receptacles for GKS-103 ... M:

K S - 1 0 3 3 0 M 2,5 K S - 1 0 3 3 0 M 2,5 - S K S - 5 0 0 M 2,5

Spacers\*:

D S - 1 0 3 0 2 D S - 1 0 3 0 3 D S - 1 0 3 0 5

Grid:  
 ≥ 4,00 mm  
 ≥ 160 Mil

Installation Height: 13,0 mm (.512)  
 Recommended Stroke: 5,6 mm (.220)

## Mounting and Functional Dimensions

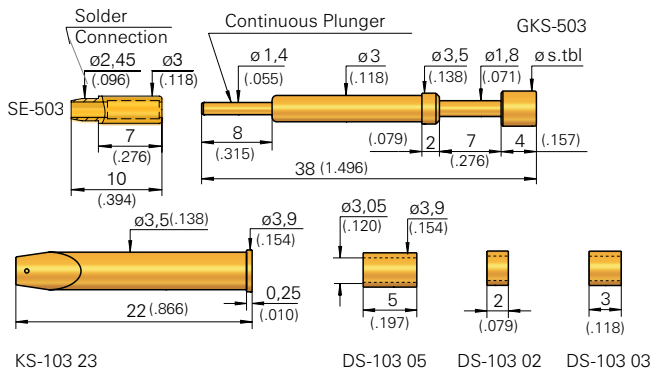

## GKS-503 ... M

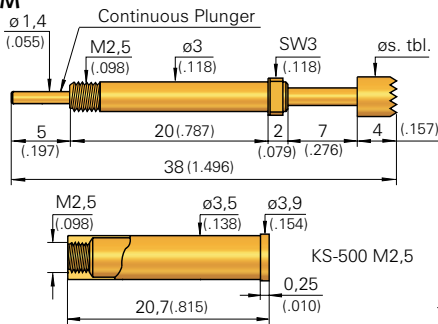

### Collar Height and Installation Height

The Installation Height of the Tip is determined by the Collar Height.

Collar Height	Installation Height (without Receptacles)
02	13,0 mm (.512)

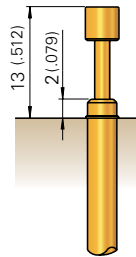

### Mechanical Data

Working Stroke: 5,6 mm (.220)  
 Maximum Stroke: 7,0 mm (.276)  
 Spring Force at Work. Stroke: 1,5 N (5.4oz)  
 alternative: 3,0 N (10.8oz), 5,0 N (18.1oz)

### Electrical Data

Current Rating, Conn. to Plunger: 12-15 A  
 Current Rating, Connection to KS: 5 - 8 A  
 $R_i$  typical, Connection to Plunger: < 10 m $\Omega$   
 $R_i$  typical, Connection to KS: < 30 m $\Omega$   
 (\*\* > 100 m $\Omega$ )

### Operating Temperature

Standard: -40° up to +80° C  
 \*\* with 5,0 N-Spring: -100° up to +200° C

### Materials

Plunger: Steel or BeCu, gold- or rhodium-plated  
 Barrel: Brass, gold-plated  
 Spring: Steel, gold-plated or Stainless Steel\*\*  
 Receptacle: Brass, gold-plated

### Mounting Hole Size

with Receptacle:  $\phi$  3,48 - 3,49 mm (.1370 - .1374)  
 without Receptacle:  $\phi$  3,00 mm (.1181)

## Available Tip Styles

Material	Tip Style	Plating	Further Versions	
			$\phi$	$\phi$ (inch)
2 01		R	$\phi$ 1,80 (.071)	
3 03		A	$\phi$ 4,00 (.157)	
3 04		R	$\phi$ 4,00 (.157)	
2 05		R	$\phi$ 1,80 (.071)	
3 06		R A	$\phi$ 4,00 (.157)	3,00 R (.118)
2 06		R	$\phi$ 1,80 (.071)	

### \* Note:

The Receptacle can be used from Grid 4,50 mm (177 Mil) up.

- Usage of Spacers is not possible with GKS-503 ... M.
- Usage of the Test Probe with Spacer DS-103 03 and DS-103 05 is only possible with KS-103 23-2 (i.e. Receptacle with stronger crimp in upper crimp position.)

### Note:

GKS-503 ... M will be screwed into Receptacle KS-500 M2.5; using special tools (see Page 170/171).

Recommended Screw-in Torque:  
 Min.: 10 Ncm / Max.: 20 Ncm

### Tools:

Insertion and Extraction Tools for GKS and KS see Page 118.

## Ordering Example

	Series	Tip Material 2 = Steel 3 = BeCu	Tip Style	Tip Diameter (1/100 mm)	Plating A = Gold R = Rhodium	Spring Force (dN)	Collar Height (mm)	Type alternative „C“; „M“; „MC“
Test Probe:	G K S	5 0 3	2 0 1	1 8 0	R	1 5	0 2	
Receptacles:	K S - 1 0 3 2 3	K S - 5 0 0 M 2.5						
Spacers*:	D S - 1 0 3 0 2	* D S - 1 0 3 0 3	* D S - 1 0 3 0 5					
Lamellar Plug: (for plugging onto the end of the Plunger)	S E - 5 0 3							

# GKS 364

Test Probe with continuous Plunger

## Grid:

≥ 6,50 mm

≥ 260 Mil

Installation Height: 6,0 mm (.236)

Recommended Stroke: 4,0 mm (.157)

## Mounting and Functional Dimensions

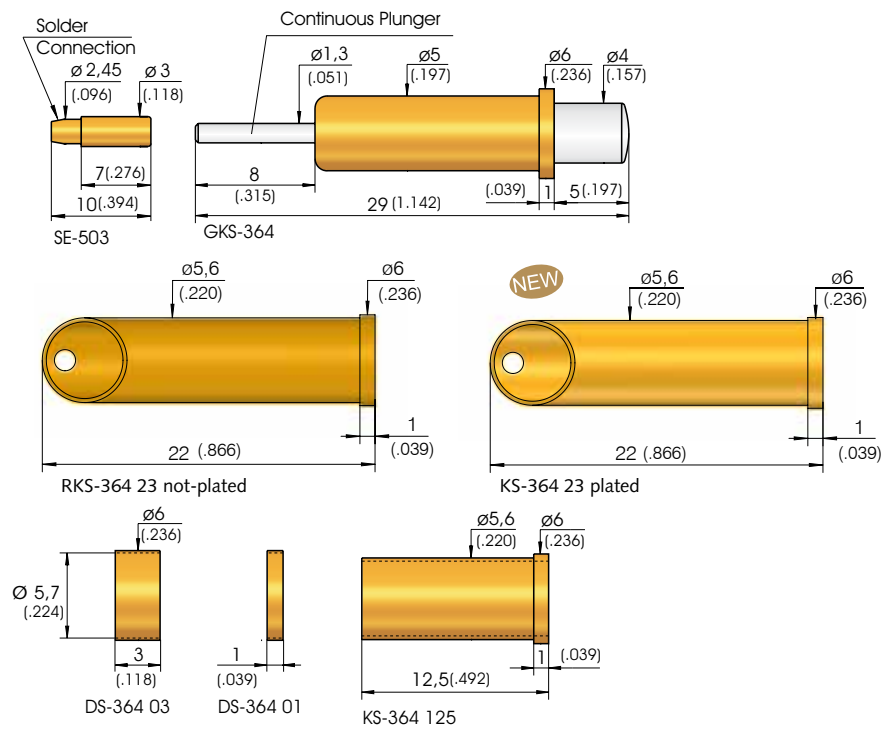

## Available Tip Styles

Material	Tip Style	Plating	Further Versions	
			$\varnothing$	$\varnothing$ (inch)
2 01*		N		
2 04		N		
2 05		N		
2 06		N		

\* Angle of Tip 60°

### Mechanical Data

**Working Stroke:** 4,0 mm (.157)  
**Maximum Stroke:** 5,0 mm (.197)  
**Spring Force at Work. Stroke:** 1,5 N (5.4oz)  
**alternative:** 0,6 N (2.2oz); 3,0 N (10.8oz), 8,0 N (28.9oz)

### Materials

**Plunger:** Steel, nickel-plated  
**Barrel:** Brass, gold-plated  
**Spring:** Steel, gold-plated or Stainless Steel\*\*  
**Receptacles:**  
 RKS-364 23: Brass, not plated  
 KS-364 125: Brass, gold-plated

### Electrical Data

**Current Rating, Conn. to Plunger:** 15-20 A  
**Current Rating, Connection to KS:** 5 - 8 A  
**R<sub>i</sub> typical, Connection to Plunger:** < 10 mΩ  
**R<sub>i</sub> typical, Connection to KS:** < 30 mΩ  
 (\*\* < 100 mΩ)

### Mounting Hole Size

**with Receptacle:**  $\varnothing$  5,59 - 5,60 mm (.2201 - .2205)  
**without Receptacle:**  $\varnothing$  5,00 mm (.1969)

### Operating Temperature

**Standard:** -40° up to +80° C  
**\*\*with 1,5 and 3,0 N-Spring:** -100° up to +200° C

## Ordering Example

	Series	Tip Material 2 = Steel	Tip Style	Tip Diameter (1/100 mm)	Plating N = Nickel	Spring Force (dN)	Collar Height (mm)
Test Probe:	G K S	3 6 4	2 0 4	4 0 0	N	1 5	0 1
Receptacles:	R K S - 3 6 4 2 3	K S - 3 6 4 2 3	K S - 3 6 4 1 2 5				
Spacer for Receptacle:	D S - 3 6 4 0 3						
Lamellar Plug: (for plugging onto the end of the Plunger)	S E - 5 0 3						

Grid:  
≥ 6,50 mm  
≥ 260 Mil

Installation Height: 6,0 mm (.236) resp. 11,0 mm (.433)  
Recommended Stroke: 3,2 mm (.126) reps. 8,0 mm (.315)

## Mounting and Functional Dimensions

### GKS 365

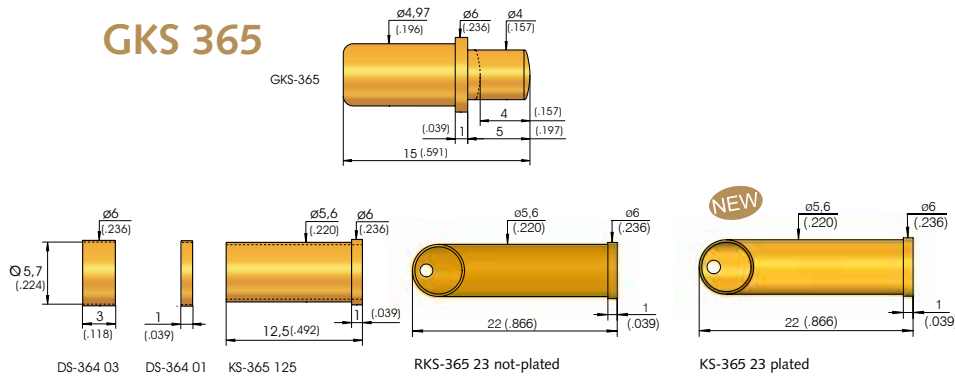

### Available Tip Styles GKS 365

Material	Tip Style	Plating	Further Versions	
			∅	∅ (inch)
2 04		N		
1 05		A		
2 06		A		
1 13 *		N		
1 13S **		A		

\* No radial Forces allowed. Plunger can get stuck  
\*\* Ordering Example: GKS-365 113 400 A xx01 S

### GKS 366

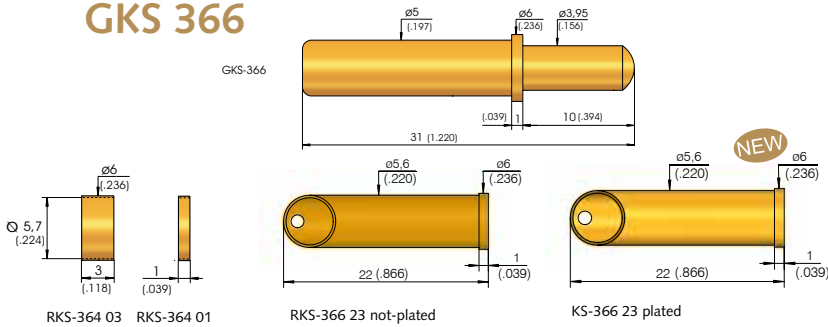

### Available Tip Styles GKS 366

Material	Tip Style	Plating	Further Versions	
			∅	∅ (inch)
1 05		N		
3 05		A		
3 56 *		A		

\* Total Length = 30 mm, maximum Stroke 9,0 mm

#### Mechanical Data GKS 365

**Working Stroke:** 3,2 mm (.126)  
**Maximum Stroke:** 4,0 mm (.157)  
**Spring Force at Work. Stroke:** 1,5 N (5.4oz)  
**alternative:** 0,6 N (2.2oz); 3,0 N (10.8oz), 4,0 N (14.4oz); 8,0 N (28.9oz)

#### Mechanical Data GKS 366

**Working Stroke:** 8,0 mm (.315)  
**Maximum Stroke:** 10,0 mm (.394)  
**Spring Force at Work. Stroke:** 1,5 N (5.4oz)  
**alternative:** 3,0 N (10.8oz); 6,0 N (21.6oz); 8,0 N (28.9oz); 16,0 N (57.5oz)

#### Electrical Data

**Current Rating:** 5 - 8 A  
**R<sub>i</sub> typical:** < 30 mΩ (\*\* < 100 mΩ)

#### Materials

**Plunger:** Brass or Steel, gold- or nickel-plated  
**Barrel:** Brass, gold-plated  
**Spring:** Steel, gold-plated or Stainless Steel\*\*

#### Receptacle for GKS-365:

RKS-365 23: Brass, not plated  
KS-365 125: Brass, gold-plated

#### Receptacle for GKS-366:

RKS-364 23: Brass, not plated  
KS-364 125: Brass, gold-plated

#### Operating Temperature

**Standard:** -40° up to +80° C  
**\*\*with 8,0 N-Spring:** -100° up to +200° C (GKS-365)

#### Mounting Hole Size

**with Receptacle:** ∅ 5,59 - 5,60 mm (.2201 - .2205)  
**without Receptacle for GKS-365:** ∅ 4,97 mm (.1957)  
**without Receptacle for GKS-366:** ∅ 5,00 mm (.1969)

#### Note:

Other comparable Versions on request.

## Ordering Example

Series	Tip Material 1 = Brass 2 = Steel	Tip Style	Tip Diameter (1/100 mm)	Plating A = Gold N = Nickel	Spring Force (dN)	Collar Height (mm)	Special Designation "S"
Test Probe:	G K S	3 6 5	1 0 5	4 0 0	A	1 5	0 1
Test Probe:	G K S	3 6 6	1 0 5	4 0 0	N	1 5	0 1
Receptacles for GKS-365:	R K S - 3 6 5 2 3	K S - 3 6 5 2 3 A					
Receptacles for GKS-366:	R K S - 3 6 6 2 3	K S - 3 6 6 1 2 5		K S - 3 6 6 2 3			
Spacer for Receptacle:	D S - 3 6 4 0 1	D S - 3 6 4 0 3					

e-type® Probes  
ICT / FCT  
Bead Probes  
Fine Pitch  
Metric Stand.  
Solderable  
Short-stroke  
Flying Probes  
DKS  
SKS  
PKS / PSK  
RF / Dipole Test Probes  
HSS  
Fixture customizing  
Tools  
Cable Test Probes

# Spring-loaded Test Probes for Medical Technology



The increasing quality demands in the Medical Technology require high-grade solutions. If conventional contacts cannot satisfy the application requirements, then the usage of spring-loaded Test Probes from INGUN becomes necessary. The design of an INGUN Test Probe, which is based on many years of experience, consists of a Barrel, a contacting Plunger and a spiral-shaped Compression Spring, offers a wide range of advantages.

## Your demands – our solutions

### Advantages of spring-loaded Test Probes:

- Balancing out of heights and tolerances
- Compensation of errors in regard to parallelism and unevenness.
- Long-life cycle
- Resistant to impact and vibration
- Assembly also in restricted areas and conditions
- High level of conductivity
- Especially adapted gold-plating
- Very good chemical resistance
- Available in small and large quantities
- Standard and customized solutions

### Application areas for spring-loaded Contacts:

- Battery charging
- Signal Transfer Contact
- Transferring of RF signals
- Transferring of high-current
- Every type of mechanical and electrical application

You can find typical series for Medical Technology here in the catalog: GKS-064, 364, 365, 366, 761 M, 913 (M), 941, 961, 967 (M), 970, 986, HSS-520 (M)

*Example of battery charging contact (cross-section)*

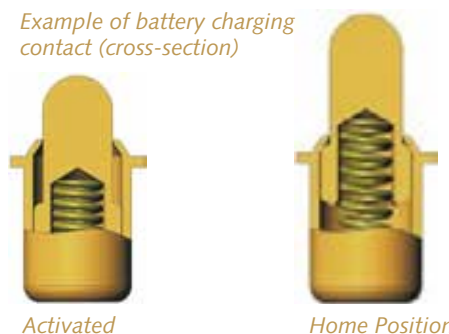

# Solderable Probes

Spring-loaded Test Probes can be used not only for test purposes in the ICT/FCT field but can also be soldered directly into or onto PC-Boards and Electronic Units. In such cases the Test Probes normally provide a current or allow an exchange of the Unit during maintenance without any soldering work. The Test Probes are soldered directly into the PC-Board and are used without a Receptacle.

**Note: Soldering of the Test Probes demands greater care. High temperatures are not allowed to get inside the barrel, because otherwise the spring could be damaged.**



# Solderable Probes

GKS-941	66
GKS-064	66
GKS-986	66



# GKS 941/GKS 064/GKS 986

Solderable Test Probes

**Grid:**

≥ 1,91 mm

≥ 75 Mil

**Installation Height:** 17,5 mm (.689)

**Recommended Stroke:** 3,2 mm (.126)

## GKS 941

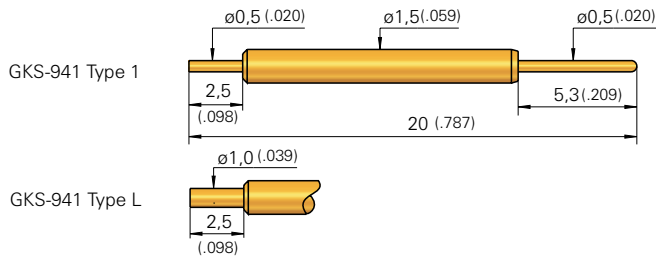

### Available Tip Styles

Material	Tip Style	Plating	Further Versions	
			∅	∅ (inch)
3	01	R	∅ 0,50 (.020)	
3	05	A	∅ 0,50 (.020)	

## GKS 064

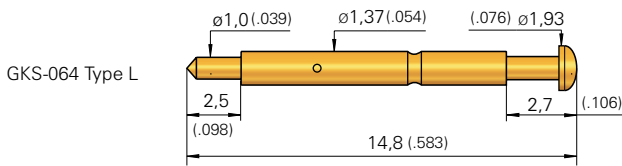

**Grid:**

≥ 2,54 mm

≥ 100 Mil

**Installation Height:** 12,3 mm (.484)

**Recommended Stroke:** 1,4 mm (.055)

### Available Tip Styles

Material	Tip Style	Plating	Further Versions	
			∅	∅ (inch)
3	05	A	∅ 1,93 (.076)	

## GKS 986

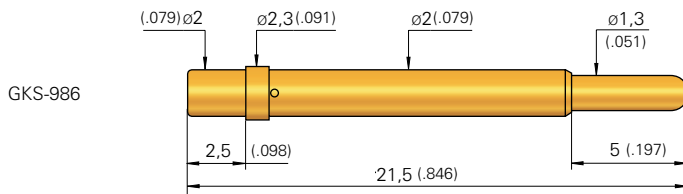

**Grid:**

≥ 2,54 mm

≥ 100 Mil

**Installation Height:** 19,0 mm (.748)

**Recommended Stroke:** 3,0 mm (.118)

### Available Tip Styles

Material	Tip Style	Plating	Further Versions	
			∅	∅ (inch)
1	05	A	∅ 1,30 (.051)	

### Mechanical Data

	GKS 941	GKS 064	GKS 986
<b>Working Stroke:</b>	3,2 mm (.126)	1,4 mm (.055)	3,0 mm (.118)
<b>Maximum Stroke:</b>	4,0 mm (.157)	1,7 mm (.067)	5,0 mm (.197)
<b>Spring Force at Work. Stroke:</b>	*0,8 N (2.9oz)	0,4 N (1.4oz)	*1,0 N (3.6oz)
<b>alternative:</b>	1,7 N (6.1oz); 3,5 N (12.6oz)	0,2 N (0.7oz); 0,6 N (2.2oz)	

### Operating Temperature

<b>Standard:</b>	-40° up to +80° C
<b>*with 0,8 N + 1,0 N-Spring:</b>	-100° up to +200° C

### Electrical Data

	GKS 941	GKS 064	GKS 986
<b>Current Rating:</b>	5 - 8 A	5 - 8 A	5 - 8 A
<b>R<sub>i</sub> typical:</b>	<100 mΩ	<100 mΩ	<100 mΩ

### Other Solderable Test Probes:

see GKS-913 and others on request

### Materials

	GKS 941	GKS 064	GKS 986
<b>Plunger:</b>	BeCu, gold- or rhodium-plated	see GKS 941	Brass, gold-plated
<b>Barrel:</b>	Brass, gold-plated	see GKS 941	Brass, gold-plated
<b>Spring:</b>	Steel, gold-plated *0,8 N, Stainless Steel, gold-plated	see GKS 941	Steel, gold-plated *0,8 N, Stainless Steel, gold-plated

### Warning:

Soldering the Probes demands great care. High temperatures must not reach the inside of the barrel, because this could destroy the spring.

## Ordering Example

	Series	Tip Material 1 = Brass 3 = BeCu	Tip Style	Tip Diameter (1/100 mm)	Plating A = Gold R = Rhodium	Spring Force (dN)	Collar Height (mm)	Type „1“ resp. „L“
Test Probe with Terminal Post ∅ 0,5 or 1,0 mm:	G K S	9 4 1	3 0 1	0 5 0	R	0 8	0 0	1 or L
Test Probe with Terminal Post ∅ 1,0 mm:	G K S	0 6 4	3 0 5	1 9 3	A	0 4	0 0	L
Test Probe GKS-986:	G K S	9 8 6	1 0 5	1 3 0	A	1 0	0 1	

# Short-stroke Probes / Charging Probes

Short-stroke Probes are used as battery contacts or as a transfer pin in charging units. The Test Probes have not only a very compact design but also a short installation height in conjunction with a high spring-force.

For usage directly on the PC-Board, INGUN recommends the series **GKS-967** with a closed barrel end, so that no solder can get into the barrel during the soldering process.

Should the Test Probes need to be exchanged sometimes, then these Test Probes can be installed with a Receptacle.

Due to the extremely short design of the Receptacle (only 2.5mm long), exchange solutions are possible even when installed directly in the PC-Board.

Special versions as well as non-magnetic variants are available on request.

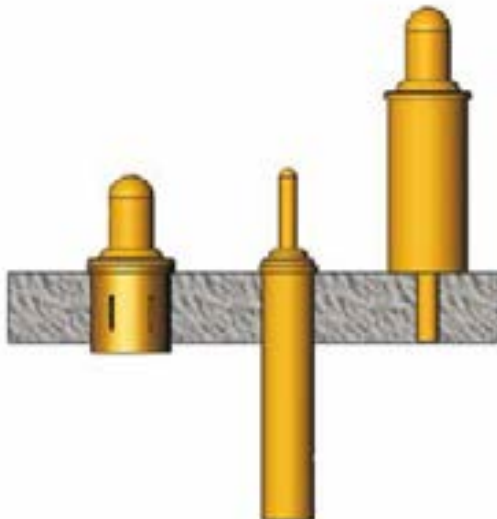

# Short-stroke Probes / Charging Probes

GKS-967 / 967 M	68
GKS-761M	69
GKS-970	69
GKS-961	69

# GKS 967

Short-stroke and Charging Test Probes

**Grid:**

≥ 3,00 mm

≥ 120 Mil

**Installation Height:** 2,6 resp. 4,1 mm (.102/ .161)

**Recommended Stroke:** 1,0 mm (.039)

## Mounting and Functional Dimensions

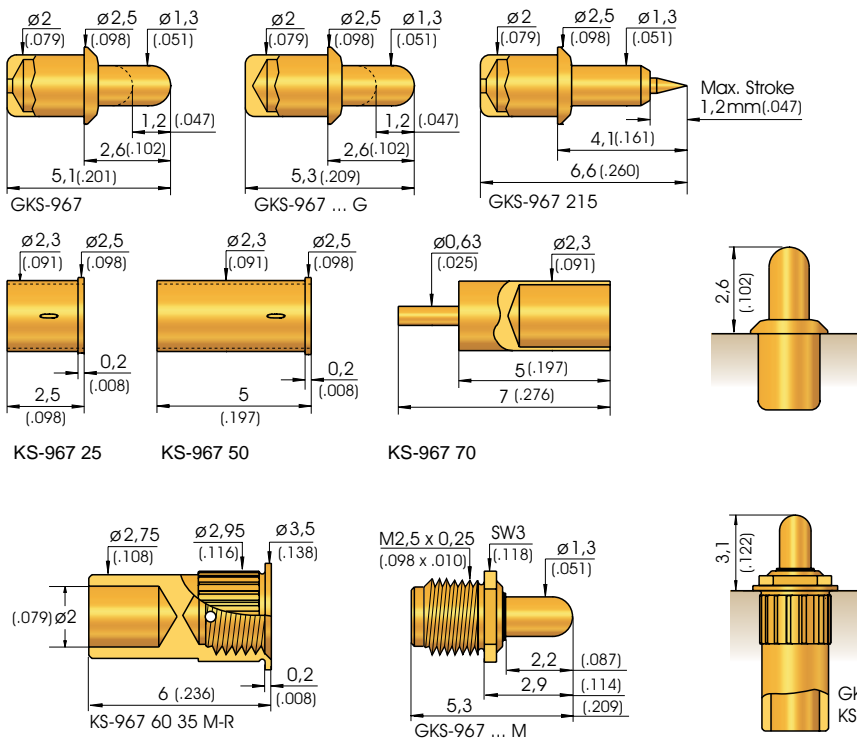

## Available Tip Styles

Material	Tip Style	Plating	Further Versions	
			∅	∅ (inch)
3 02		A		
3 03		A		
3 04		A		
3 05		A		
3 06		A		
2 15*		A		

\* Installation Height: 4,1 mm (.161)

### Mechanical Data

**Working Stroke:** 1,0 mm (.039)  
**Maximum Stroke:** 1,2 mm (.047)  
**Spring Force at Work. Stroke:** 2,0 N (7.2oz)  
**alternative:** 1,0 N (3.6oz)

### Electrical Data

**Current Rating:** 5 - 8 A  
**R<sub>i</sub> typical:** < 10 mΩ  
 (\* < 100 mΩ)

### Materials

**Plunger:** BeCu or steel, gold-plated  
**Barrel:** Brass, gold-plated  
**Spring:** Stainless Steel\*, Steel, gold-plated  
**Receptacle:** Brass, gold-plated

### Mounting Hole Size

**GKS 967**  
**in CEM1 and FR4**  
**with Receptacle:** ∅ 2,28 - 2,29 mm  
 (.0898 - .0902)  
**without Receptacle:** ∅ 2,00 mm (.0787)

### Mounting Hole Size

**GKS 967 ... M**  
**in CEM1 und FR4**  
**with Receptacle:** ∅ 2,92 - 2,94 mm  
 (.1150 - .1157)

### Operating Temperature

**Standard:** -40° up to +80° C  
**\*with Special Designation „C“ or „G“:**  
 -100° up to +200° C (1,0 N; 2,0 N)

**Note:**

GKS-967 ... M will be screwed into Receptacle KS-967 60 35 M-R; using special tools (see Page 170/171).

Recommended Screw-in Torque:  
 Min.: 3 Ncm / Max.: 5 Ncm

## Ordering Example

	Series	Tip Material 1 = Brass 3 = BeCu	Tip Style	Tip Diameter (1/100 mm)	Plating A = Gold R = Rhodium	Spring Force (dN)	Collar Height (mm)	Type „C“, „G“, „M“ or „MC“
Test Probe:	G K S	9 6 7	3	0 4	1 3 0	A	2 0	0 1
Receptacles:	K S - 9 6 7 2 5	K S - 9 6 7 5 0	K S - 9 6 7 7 0					
Test Probe (Page 69):	G K S	7 6 1	3	0 5	0 8 0	A	1 0	0 1 M
Receptacle (Page 69):	K S - 7 6 1 6 0 3 5 M - R							
Test Probe (Page 69):	G K S	9 7 0	3	0 5	1 3 0	A	2 0	0 1
Test Probe (Page 69):	G K S	9 6 1	3	0 5	0 5 0	A	0 6	0 1
Receptacle (Page 69):	K S - 9 6 1 3 5							

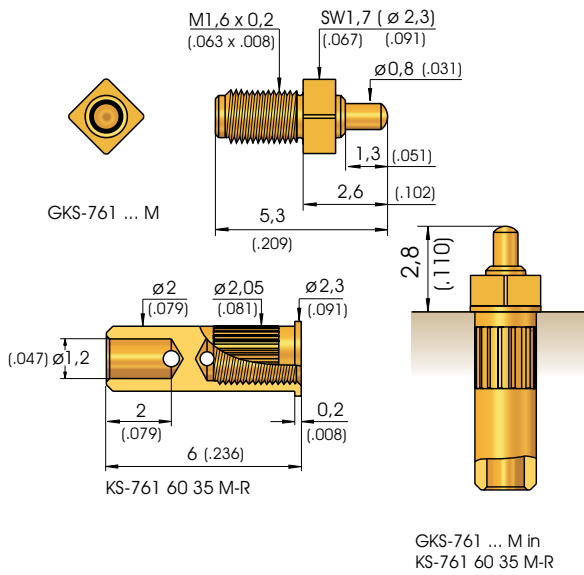

**Note:**  
GKS-761 ... M will be screwed into Receptacle KS-761 60 35 M-R; using special tools (see Page 170/171).

Recommended Screw-in Torque:  
Min.: 3 Ncm / Max.: 5 Ncm

## GKS 761 M

**Grid:**  
≥ 2,54 mm  
≥ 100 Mil

**Installation Height:** 2,6 mm (.102) resp. 2,8 mm (.110)  
**Recommended Stroke:** 1,0 mm (.039)

### Available Tip Styles

Material	Tip Style	Plating	Further Versions	
			∅	∅ (inch)
3 05		A	∅ 0,80 (.032)	

## GKS 970

**Grid:**  
≥ 3 mm  
≥ 120 Mil

**Installation Height:** 2,6 mm (.102) bzw. 5,1 mm (.201)  
**Recommended Stroke:** 1,0 mm (.039) bzw. 2,8 mm (.110)

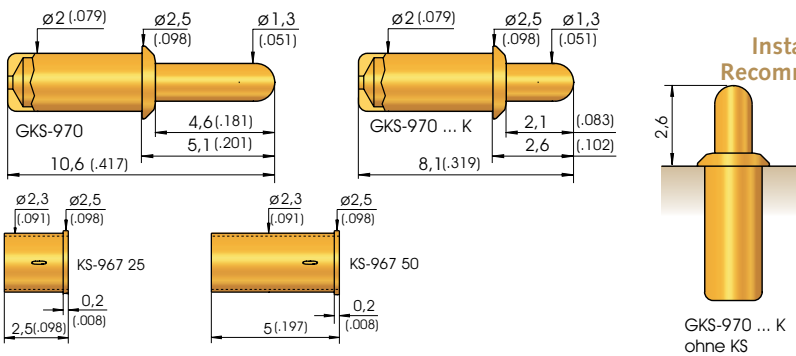

### Available Tip Styles

Material	Tip Style	Plating	Further Versions	
			∅	∅ (inch)
3 05		A	∅ 1,30 (.051)	

## GKS 961

**Grid:**  
≥ 1,91 mm  
≥ 75 Mil

**Installation Height:** 2,8 mm (.110)  
**Recommended Stroke:** 1,0 mm (.039)

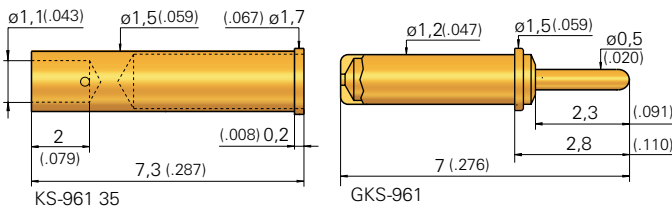

### Available Tip Styles

Material	Tip Style	Plating	Further Versions	
			∅	∅ (inch)
3 05		A	∅ 0,50 (.020)	

Mechanical Data		Mechanical Data		Mechanical Data	
GKS 761 M		GKS 961		GKS 970 (970...K)	
<b>Working Stroke:</b>	1,0 mm (.039)	<b>Working Stroke:</b>	1,0 mm (.039)	<b>Work. Stroke:</b>	2,8 mm (.110) (1,0 mm(.039))
<b>Maximum Stroke:</b>	1,2 mm (.047)	<b>Maximum Stroke:</b>	1,3 mm (.051)	<b>Max. Stroke:</b>	3,3 mm (.130) (1,7 mm (.067))
<b>Spring Force at Work.Stroke:</b>	1,0 N (3.6oz)	<b>Spring Force at Work.Stroke:</b>	0,6 N (2.2oz)	<b>Spring Force at Work.Stroke:</b>	1,0 N (3.6oz); 2,0 N (7.2oz); (2,0 N (7.2oz))
<b>Electrical Data</b>		<b>Electrical Data</b>		<b>Electrical Data</b>	
GKS 761 M		GKS 961		GKS 970	
<b>Current Rating:</b>	5 A	<b>Current Rating:</b>	2 A	<b>Current Rating:</b>	5 - 8 A
<b>R<sub>j</sub> typical:</b>	< 20 mΩ	<b>R<sub>j</sub> typical:</b>	< 100 mΩ	<b>R<sub>j</sub> typical:</b>	< 20 mΩ * < 100 mΩ
<b>Materials</b>		<b>Materials</b>		<b>Materials</b>	
GKS 761 M		GKS 961		GKS 970	
<b>Plunger:</b>	BeCu, gold-plated	<b>Plunger:</b>	BeCu, gold-plated	<b>Plunger:</b>	BeCu, gold-plated
<b>Barrel:</b>	Brass, gold-plated	<b>Barrel:</b>	Brass, gold-plated	<b>Barrel:</b>	Brass, gold-plated
<b>Spring:</b>	Steel, gold-plated	<b>Spring:</b>	Stainless Steel, gold-plated	<b>Spring:</b>	Stainless Steel, Steel, gold-plated
<b>Receptacle:</b>	Brass, gold-plated	<b>Receptacle:</b>	Brass, gold-plated	<b>Receptacle:</b>	Brass, gold-plated
<b>Mounting Hole Size</b>		<b>Mounting Hole Size</b>		<b>Mounting Hole Size</b>	
GKS 761 M		GKS 961		GKS 970	
<b>in CEM1 and FR4</b>		<b>in CEM1 and FR4</b>		<b>in CEM1 and FR4</b>	
<b>with KS-761 60 35 M-R</b>		<b>with Receptacle:</b>		<b>with Receptacle:</b>	
∅ 2,00 - 2,02 mm (.0787 - .0866)		∅ 1,49 - 1,50 mm (.0587 - .0591)		∅ 2,28 - 2,29 mm (.0898 - .0902)	
		<b>without Receptacle:</b>		<b>without Receptacle:</b>	
		∅ 1,2 mm (.0472)		∅ 2,0 mm (.0787)	
<b>Operating Temperature</b>		<b>Operating Temperature</b>		<b>Operating Temperature</b>	
Standard:		Standard:		Standard:	
-40° up to +80° C		-100° up to +200° C		-40° up to +80° C *with Special Designation „C“: -100° up to +200° C (1,0 N; 2,0 N)	

e-type® Probes  
ICT / FCT  
Bead Probes  
Fine Pitch  
Metric Stand.  
Solderable  
Short-stroke  
Flying Probes  
DKS  
SKS  
PKS / PSK  
RF / Dipole Test Probes  
HSS  
Fixture customizing  
Tools  
Cable Test Probes



# Flying Probes

---

For usage with Flying Probe Systems from Scorpion/Acculogic and Digitaltest INGUN recommends the series GKS-112 MD.

The geometry of the barrel was especially designed for this special Probe so that maximum precision and contacting accuracy is achieved. A special beading design enables contacting in a grid of 0.15 mm.

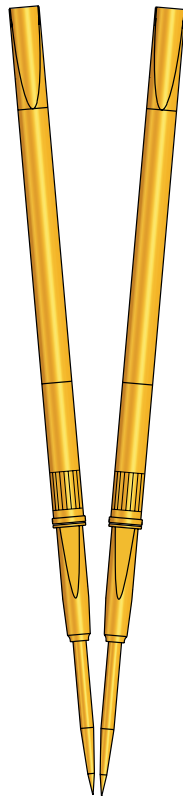

# Flying Probes

GKS-112 MD

72



# GKS 112 MD

Test Probes for Flying Probe  
Test Systems Scorpion/Acculogic and Digitaltest

## Grid:

≥ 2,54 mm  
≥ 100 Mil

Installation Height: 14,7 - 21,6 mm (.579 - .850)

Recommended Stroke: 4,0 mm (.157)

## Mounting and Functional Dimensions

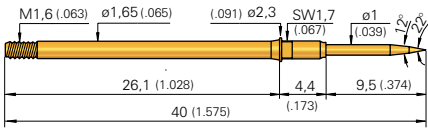

GKS-112 201 112 A xx05 MD

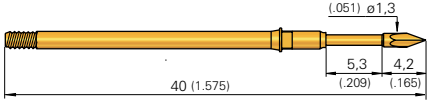

GKS-112 291 130 A xx05 MD

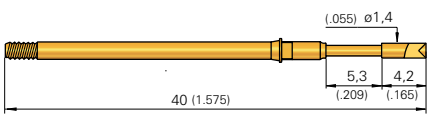

GKS-112 253 140 A xx05 MD

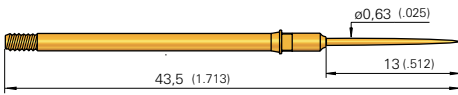

GKS-112 259 060 A xx05 MD

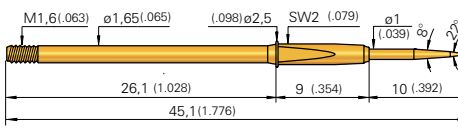

GKS-112 201 108 A xx10 MDL

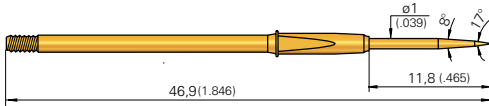

GKS-112 251 108 A xx10 MDL

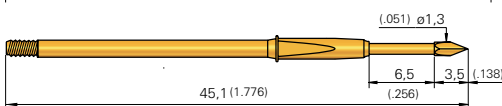

GKS-112 291 130 A xx10 MDL

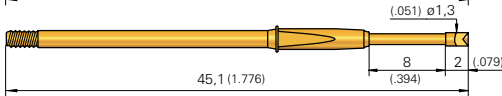

GKS-112 303 130 A xx10 MDL

Type	Oper. stroke in mm (inch)	Max. Stroke in mm (inch)	Inst.- Height with KS in mm (inch)
01...05 MD	4,0 (.157)	8,0 (.315)	14,7 (.579)
91...05 MD	4,0 (.157)	5,3 (.209)	14,7 (.579)
53...05 MD	4,0 (.157)	5,3 (.209)	14,7 (.579)
59...05 MD	4,0 (.157)	8,0 (.315)	18,2 (.717)
01...10 MDL	4,0 (.157)	8,0 (.315)	19,8 (.780)
51...10 MDL	4,0 (.157)	8,0 (.315)	21,6 (.850)
91...10 MDL	4,0 (.157)	6,5 (.256)	19,8 (.780)
03...10 MDL	4,0 (.157)	8,0 (.315)	19,8 (.780)

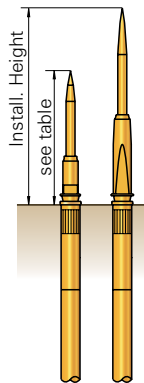

### Materials

**Plunger:** Steel or BeCu, gold-plated  
**Barrel:** Brass, gold-plated  
**Spring:** Steel, gold-plated  
**Receptacle:** Brass, gold-plated

### Mechanical Data

**Spring Force at Work. Stroke:** 1,5 N (5.4oz)  
**alternative:** 0,6 (2.2oz); 0,8 (2.9oz); 2,25 (8.1oz); 3,0 N (10.8oz)

## Available Tip Styles

Version GKS-112 ... 05 MD

Material	Tip Style	Plating	Further Versions	
			Ø	Ø (inch)
2 01		A	Ø 1,12 (.044)	
2 91		A	Ø 1,30 (.051)	
2 53		A	Ø 1,40 (.055)	
2 59		A	Ø 0,60 (.024)	

## Available Tip Styles

Version GKS-112 ... 10 MDL

Material	Tip Style	Plating	Further Versions	
			Ø	Ø (inch)
2 01		A	Ø 1,08 (.043)	
2 51		A	Ø 1,08 (.043)	
2 91		A	Ø 1,30 (.051)	
3 03		A	Ø 1,30 (.051)	

### Note:

GKS-112 ... MD and MDL will be screwed in KS-112 ... M using special Tools > see example below and other tools on Page 170/171.

Receptacles KS-112 ... M:  
see Page 132.

Recommended Screw-in Torque:  
Min.: 3 Ncm / Max.: 5 Ncm

### Electrical Data

**Current Rating:** 5 - 8 A  
**R<sub>i</sub> typical:** < 20 mΩ

### Operating Temperature

**Standard:** -40° up to +80° C

### Mounting Hole Size

**for KS-112 xx M and KS-112 xx M-T**  
**in CEM 1 and FR 4:** Ø 1,99 mm (.0783)  
**for KS-112 xx M-R**  
**in CEM 1 and FR 4:** Ø 2,00 - 2,02 mm (.0787 - .0795)

## Ordering Example

Series	Tip Material	Tip Style	Tip Diameter	Plating	Spring Force	Collar Height	Special Designation
	2 = Steel 3 = BeCu		(1/100 mm)	A = Gold	(dN)	(mm)	alternative „MDL“

Test Probe:

G K S 1 1 2 2 0 1 1 1 2 A 1 5 0 5 M D

Receptacles (see Page 132):

K S - 1 1 2 3 0 M - T    K S - 1 1 2 3 0 M - R

Receptacles for Leakage test (see Page 132):

K S - 1 1 2 3 0 M

Screw-in Tool for GKS-112 ... 05 MD:

B I T - G K S 1 1 2 M - B

Screw-in Tool for GKS-112 ... 10 MDL:

B I T - G K S 1 1 2 M - B - F P

# Rotating Probes

In the case of badly contaminated components or e.g. anodized aluminium and similar surfaces, common Test Probes cannot guarantee a reliable contact.

To enable reliable contacting of such surfaces INGUN recommends Rotating Probes that have a rotating plunger, which digs itself into the surface. The rotating movement of the Plunger provides reliable breaking open of the surface. However, maintenance should take into consideration that this could lead to a higher level of contamination due to particles set free during contacting.

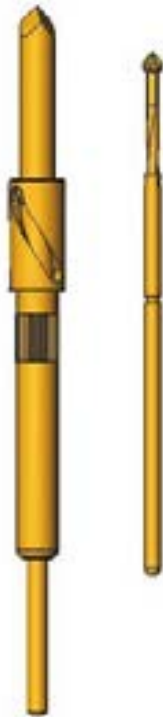

# Rotating Probes

DKS-050	74
DKS-075	74
DKS-100	74
GKS-725	75
GKS-713	76

# DKS Rotating Probe

Test Probes for problematic contacting demands

## Grid:

≥ 1,27/1,91/2,54 mm

≥ 50/75/100 Mil

Installation Height: 16,0 mm (.630) / variable

Recommended Stroke: 4,3 mm (.169)

## Mounting and Functional Dimensions

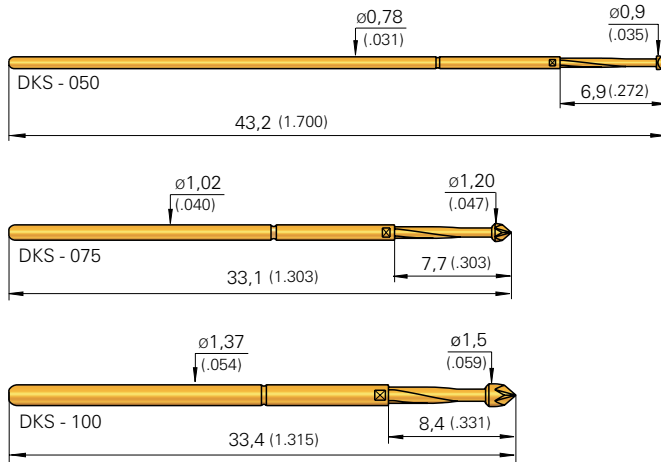

**Collar Height and Installation Height, Receptacles, Electrical Data, Mounting Hole Sizes and Materials:**  
see compatible Standard Probe Series

DKS	Compatible Probe	Page
DKS-050	GKS-050	25
DKS-075	GKS-075	26/27
DKS-100	GKS-100	28/29

### Mechanical Data

**Working Stroke:** 4,3 mm (.169)

**Maximum Stroke:** 6,35 mm (.250)

### Spring Forces of DKS-050

**Spring Force at Work. Stroke:** 1,5 N (5.4oz)  
**alternative:** 2,0 N (7.2oz)

### Spring Forces of DKS-075

**Spring Force at Work. Stroke:** 1,0 N (3.6oz)  
**alternative:** 2,0 N (7.2oz)

### Spring Forces of DKS-100

**Spring Force at Work. Stroke:** 1,0 N (3.6oz)  
**alternative:** 2,0 N (7.2oz) ; 3,0 N (10.8oz)

### Materials

**Plunger:** BeCu or Steel , gold-plated

**Barrel:** Nickel-Silver or Bronze, gold-plated

**Spring:** Steel, gold-plated

**Receptacle:** Nickel-Silver or Brass, gold-plated

### Operating Temperature

**Standard:** -40° up to +80° C

### Tools:

Insertion and Extraction Tools for GKS and KS see Page 118.

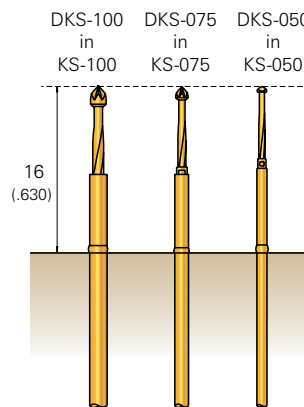

## Available Tip Styles

DKS-050

Material	Tip Style	Plating	Further Versions	
			$\varnothing$	$\varnothing$ (inch)
2	07	G	$\varnothing 0,90$ (.035)	

## Available Tip Styles

DKS-075

Material	Tip Style	Plating	Further Versions	
			$\varnothing$	$\varnothing$ (inch)
2	17	G	$\varnothing 1,20$ (.047)	
3	07	G	$\varnothing 0,76$ (.030)	

## Available Tip Styles

DKS-100

Material	Tip Style	Plating	Further Versions	
			$\varnothing$	$\varnothing$ (inch)
2	17	G	$\varnothing 1,50$ (.059)	
3	07	G	$\varnothing 1,00$ (.039)	

## Ordering Example

Series	Tip Material 2 = Steel 3 = BeCu	Tip Style	Tip Diameter (1/100 mm)	Plating G = Aurun	Spring Force (dN)	Collar Height (mm)
--------	---------------------------------------	-----------	----------------------------	----------------------	----------------------	-----------------------

Test Probes:

D	K	S	0	5	0	2	0	7	0	9	0	G	1	5	0	0
D	K	S	0	7	5	2	1	7	1	2	0	G	2	0	0	0
D	K	S	1	0	0	2	1	7	1	5	0	G	2	0	0	0

Grid:  
 ≥ 2,54 mm  
 ≥ 100 Mil

Installation Height: 13,0 resp. 16,0 mm (.512/ .630)  
 Recommended Stroke: 4,8 resp. 4,0 mm (.189/ .157)

## Mounting and Functional Dimensions

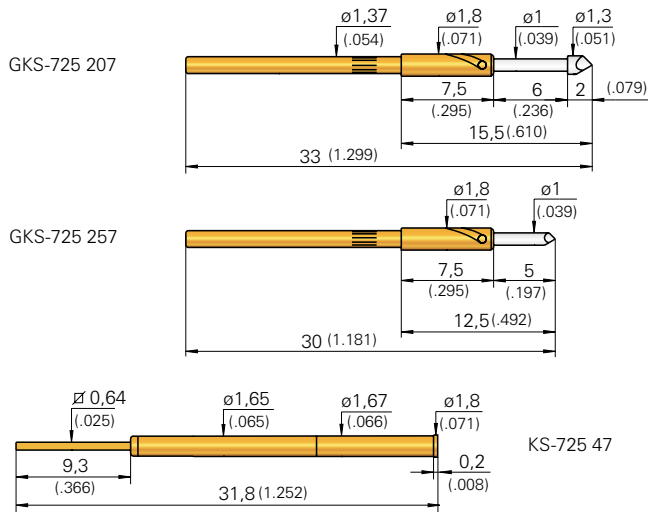

## Available Tip Styles

Material	Tip Style	Plating	Further Versions	
			$\phi$	$\phi$ (inch)
2	57* *3 mm (.118) shorter	R	$\phi 1,00$ (.039)	
2	07	R	$\phi 1,30$ (.051)	

## Collar Height and Installation Height

Tip Style	Installation Height with KS (inch)	Working Stroke (inch)	Maximum Stroke (inch)
07	16 mm (.630)	4,8 (189)	6,0 mm (.236)
57*	13 mm (.512)	4,0 (157)	5,0 mm (.197)

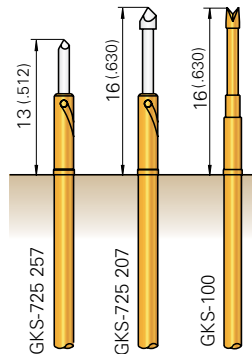

## Mechanical Data

**Working Stroke:** see table above  
**Maximum Stroke:** see table above  
**Spring Force at Work. Stroke:** 1,5 N (5.4oz)

## Materials

**Plunger:** Steel, rhodium-plated  
**Barrel:** Brass, gold-plated  
**Spring:** Steel, gold-plated  
**Receptacle:** Brass, gold-plated

## Electrical Data

**Current Rating:** 3 - 4 A  
**R<sub>i</sub> typical:** < 20 m $\Omega$

## Mounting Hole Size

**in Material CEM 1 and FR 4:**  
**with Receptacle:**  $\phi$  1,67 mm (.0657)  
**without Receptacle:**  $\phi$  1,37 mm (.0539)

## Note:

The Knurl on the Rotating Test Probe guarantees sure fitting in the Receptacle or in the Probe Plate.

The Receptacle KS-725 47 can be used with the standard Test Probe series GKS-100 (see assembly drawing).

## Tools:

Insertion and Extraction Tools for GKS and KS see Page 118.

## Ordering Example

Series	Tip Material 2 = Steel	Tip Style	Tip Diameter (1/100 mm)	Plating R = Rhodium	Spring Force (dN)	Collar Height (mm)	Type
--------	---------------------------	-----------	----------------------------	------------------------	----------------------	-----------------------	------

Test Probe:

G K S 7 2 5 2 0 7 1 3 0 R 1 5 0 7 S

Receptacle:

K S - 7 2 5 4 7

# GKS 713

Rotating Test Probe with continuous Plunger

## Grid:

≥ 4,50 mm

≥ 177 Mil

Installation Height: 13,0 resp. 18,0 mm (.512/ .709)

Recommended Stroke: 4,0 mm (.157)

## Mounting and Functional Dimensions

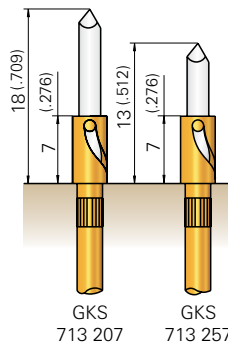
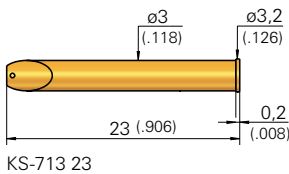
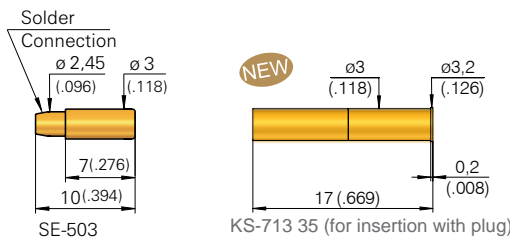
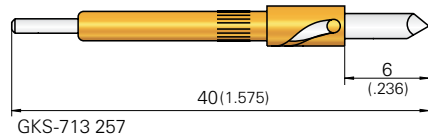
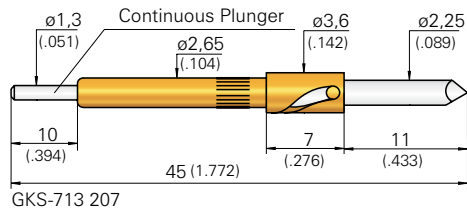

### Collar Height and Installation Height

GKS	Installation Height
713 206/207	18 mm (.709)
713 256/257	13 mm (.512)

### Mechanical Data

**Working Stroke:** 4,0 mm (.157)  
**Maximum Stroke:** 5,0 mm (.197)  
**Spring Force at Work. Stroke:** 1,5 N (5.4oz)  
**alternative:** 3,0 N (10.8oz); 5,0 N (18.1oz)

### Electrical Data

**Current Rating, Connection to KS:** 5 - 8 A  
**Current Rating, Conn. to Plunger:** 8 A  
**R<sub>i</sub> typical, Connection to KS:** < 30 mΩ  
**R<sub>i</sub> typical, Connection to Plunger:** < 10 mΩ

### Materials

**Plunger:** Steel, rhodium-plated  
**Barrel:** Brass, gold-plated  
**Spring:** Steel, gold-plated  
**Receptacle:** Brass, gold-plated

### Mounting Hole Size

**with Receptacle:** ∅ 2,98 - 2,99 mm (.1173 - .1177)  
**without Receptacle:** ∅ 2,66 mm (.1047)

### Note:

The Knurl on the Rotating Test Probe guarantees sure fitting in the Receptacle or in the Probe Plate.

### Tools:

Insertion and Extraction Tools for GKS and KS see Page 118.

Material	Tip Style	Plating	Further Versions	
			∅	∅ (inch)
2 07		R		
2 57*		R		
2 06		R	4,00	(.157)
2 56*		R		

\* 5 mm (.197) shorter

## Ordering Example

Series      Tip Material      Tip Style      Tip Diameter (1/100 mm)      Plating R = Rhodium      Spring Force (dN)      Collar Height (mm)

Test Probe:

G K S 7 1 3 2 0 6 2 2 5 R 1 5 0 7

Receptacle:

K S - 7 1 3 2 3      K S - 7 1 3 3 5

Lamellar Plug:

(for plugging onto the end of the Plunger)

S E - 5 0 3

# Switching Probes

INGUN Switching Probes are so-called "closing probes", i.e. the interrupted circuit is closed when the plunger is activated. The plunger is pushed down past the actual switching point to provide the necessary contact force. The stated rated current can be transferred in the state 2 (closed).

### Application Examples

- Presence-check of components on a PC-Board (see following section)
- Presence-check of the PC-Board on the Test Fixture
- Compact switching unit for assembly in many areas
- Signal input for procedure check of moving items on automates and other machines
- Electroless check with insulated tip

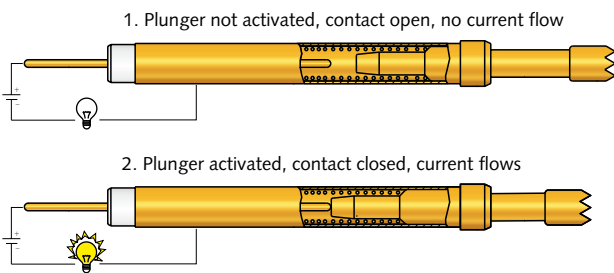

### "Quick-exchange" Receptacle for Switching Probes

To simplify the changing of Switching Probes - especially in the case of maintenance – so-called "Quick-exchange Receptacle" are available for the most common series (i.e. SKS-215 and SKS-415/465).

### Advantages

- One-time wiring of the Receptacle at the time of customizing the Test Fixture or Unit
- Insertion of the SKS from above (Test Fixture need not be opened)
- Reduction of the maintenance costs
- No wiring faults in the case of maintenance

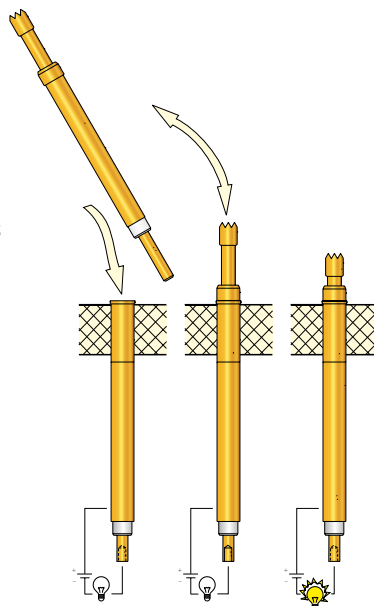

# Switching Probes

SKS-100	78
SKS-215	79
SKS-415	80
SKS-425	81
SKS-419	82
SKS-429	82

Screw-in SKS from page 147 on



# SKS 100

Switching Probe

**Grid:**

≥ 2,54 mm

≥ 100 Mil

**Installation Height:** 16,4 / 19.1 mm (.646/ .752)

**Switching Path:** 4,0 mm (.157)

## Mounting and Functional Dimensions

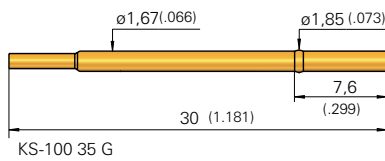
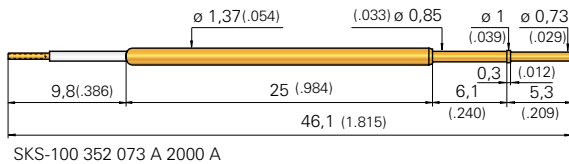
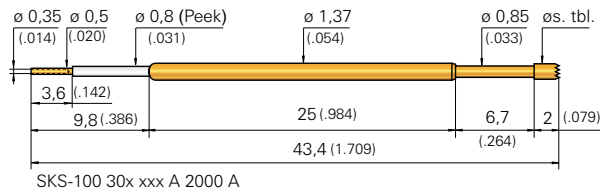

### Collar Height and Installation Height

To adjust the Installation Height Receptacles with a Press-ring are used. The Receptacles can be inserted up to the Press-ring or with the Press-ring pressed into the mounting hole.

Tip Style	Installation Height with KS (inch)	Maximum Stroke (inch)
02	16,4 mm (.646) / var.	6,3 mm (.248)
06		
52	19,1 mm (.752) / var.	6,0 mm (.236)

### Mechanical Data

**Switching Path:** 4,0 mm (.157) ± 0,2 (.008)

**Recomm. Working Stroke:** 5,0 mm (.197)

**Maximum Stroke:** 6,0 mm (.236)  
resp. 6,3 mm (.248)

**Spring Force at Switch. Point:** 1,0 N (3.6oz)

**Spring Force at Work. Stroke:** 2,0 N (7.2oz)

### Electrical Data

**Current Rating:** 3 A  
(see page 77)

### Materials

**Plunger:** BeCu, gold-plated

**Barrel:** Bronze, gold-plated

**Spring:** Steel, gold-plated

**Receptacle:** Nickel-silver, gold-plated

**Contact Terminal:** Brass, gold-plated

**Insulator:** Peek

### Mounting Hole Size

**when pressing the Pressring into the Mounting hole**

**in CEM 1 and FR 4:** ∅ 1,70 - 1,75 mm (.0669 - .0689)

**Press-ring as a Collar-stop**

**in CEM 1:** ∅ 1,68 - 1,69 mm (.0661-.0665)

**in FR 4:** ∅ 1,69 - 1,70 mm (.0665-.0669)

## Available Tip Styles

Material	Tip Style	Plating	Further Versions	
			∅	∅ (inch)
0 02		A		
3 02		A		
3 06		A		
3 52		A		

SKS-100 X02 100 ...  
SKS-100 306 100 ...  
in KS-100 35 G

SKS-100 352 073 ...  
in KS-100 35 G

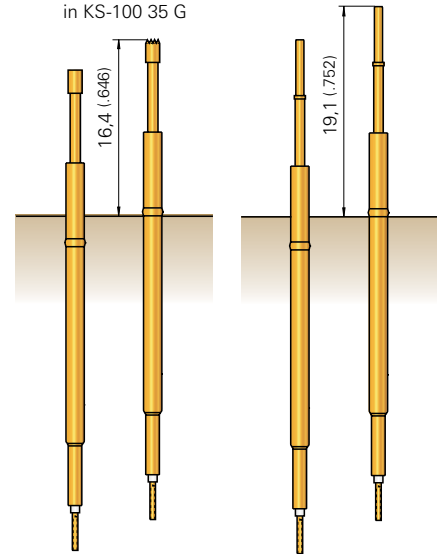

### Application Areas:

- combined component test with presence check
- active switching element

### Warning:

Do not solder the cable to the crimp points of the Receptacle.

### Tools:

Insertion and Extraction Tools for SKS and KS see Page 118.

## Ordering Example

Series	Tip Material 0 = Delrin 3 = BeCu	Tip Style	Tip Diameter (1/100 mm)	Plating A = Gold	Spring Force at Working Stroke (dN)	Collar Height (mm)	Type
--------	--	-----------	----------------------------	---------------------	---	-----------------------	------

Test Probe:

SKS 100 3 06 100 A 20 00 A

Receptacle:

KS-100 35 G

**Grid:**  
 ≥ 2,54 mm  
 ≥ 100 Mil

**Installation Height:** 10,0 mm (.394)  
**Switching Path:** 1,5 mm (.059)

## Mounting and Functional Dimensions

### SKS-215

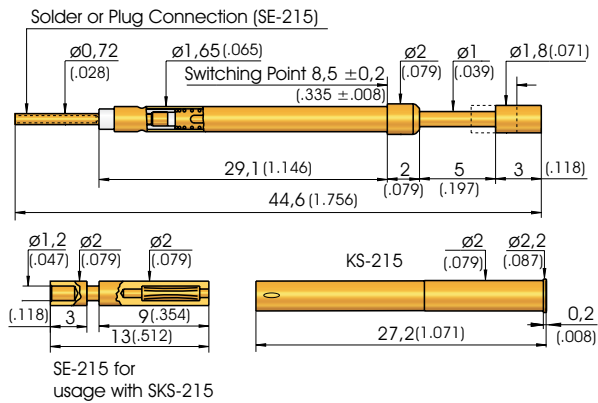

### SKS-215 ... E

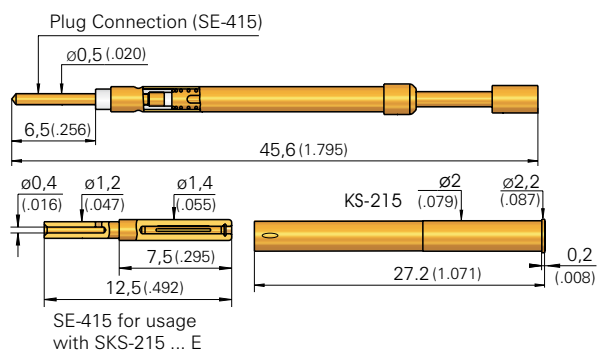

### Quick-exchange System with SKS-215 ... E

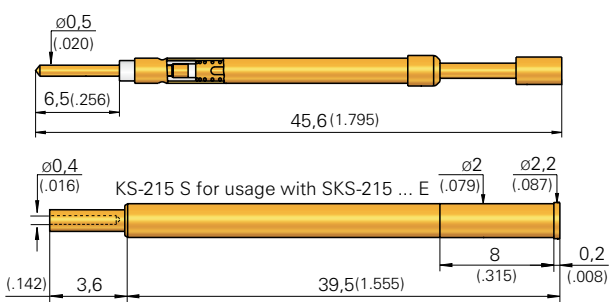

#### Mechanical Data

**Switching Path:** 1,5 mm (.059) ± 0,2 (.008)  
**Maximum Stroke:** 5,0 mm (.197)  
**Spring Force:** 0,8 / 1,5 / 3,0 N  
**Spring Force at Switch.Point:** 0,23N (0.8oz); 0,45 N (1.6oz); 0,9 N (3.2oz)  
**Spring Force at 80% Stroke:** 0,8 N (2.9oz); 1,5 N (5.4oz); 3,0 N (10.8oz)

#### Materials

**Plunger:** BeCu, gold- or nickel-plated (or gold-plated with Insulator Cap)  
**Barrel:** Brass, gold-plated  
**Spring:** Steel, gold-plated  
**Receptacle:** Brass, gold-plated  
**Contact Terminal:** Brass, gold-plated

#### Electrical Data

**Current Rating:** 3 A  
 (see page 77)

#### Mounting Hole Size

**with Receptacle:** s. KS-112 Page 50  
**without Receptacle:** ∅ 1,65 mm (.0650)

## Available Tip Styles

Material	Tip Style	Plating	Further Versions	
			∅	∅ (inch)
0 02		A		
3 02		A	1,00	(.039)
3 03		A		
NEW 3 05		A	0,80	(.031)
3 05		A		
3 06		N		
NEW 3 19		A		

#### Collar Height and Installation Height

The Installation Height of the Tip (Dimension without KS) is determined by the Collar Height.

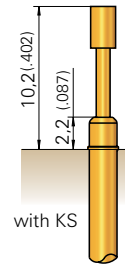

Collar Height	Installation Height (without Receptacle)
02	10,0 mm (.394)

#### Application Areas:

- combined component test with presence check
- active switching element

#### Warning:

Do not solder the cable to the crimp points of the Receptacle.

The Receptacle KS-215 S enables easy changing of the Switching Probe without removing the wiring connection. This Receptacle can only be used with SKS-215 ... E.

#### Note:

The special Tool "SW/ZW GKS-112" must be used to install the Switching Probe (see Page 118).

#### Note:

Screw-in Version see SKS-215 M on Page 148.

## Ordering Example

Series	Tip Material	Tip Style	Tip Diameter (1/100 mm)	Plating	Spring Force at 80% Stroke (dN)	Collar Height (mm)	Type (alternative E)
SKS	0 = Delrin 3 = BeCu	215	302	A = Gold N = Nickel	30	02	

Test Probe:

SKS 215 302 180 A 30 02

Receptacle:

KS-215 KS-215 S

Lamellar Plug:

SE-215

# SKS 415

Switching Probe

**Grid:**

≥ 3,50 mm

≥ 140 Mil

**Installation Height:** 10,2 - 24,7 mm (.402 - .972)

**Switching Path:** 1,7 mm (.067)

## Mounting and Functional Dimensions

### SKS-415 ... 2

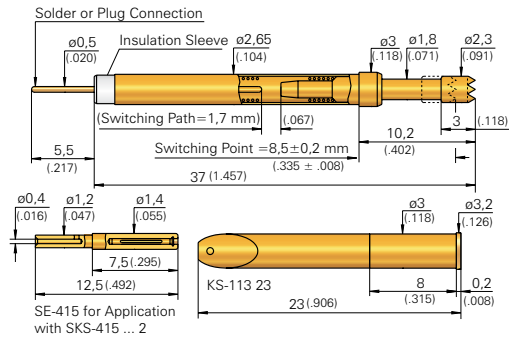

### SKS-415 ... E

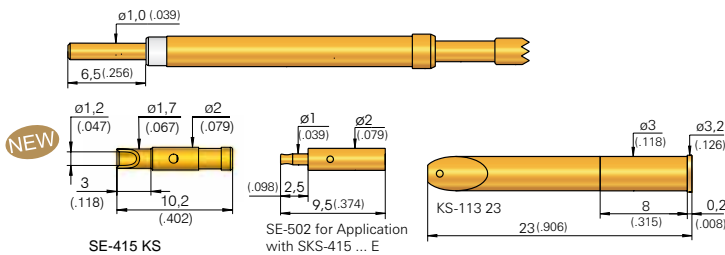

### Quick-exchange System with SKS-415 ... 02 E

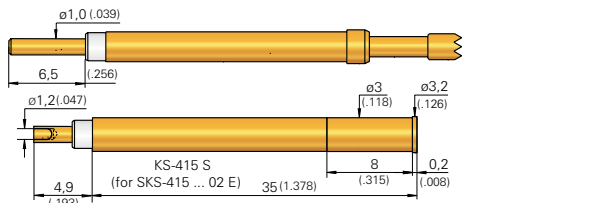

Collar Height	Installation Height (without KS) with Tip Style 02/03/06	Installation Height (without KS) with Tip Style 53/56
02	10,2 mm (.402)	16,7 mm (.657)
05**	13,2 mm (.520)	19,7 mm (.776)
10**	18,2 mm (.717)	24,7 mm (.972)

\*\* not usable with KS-415 S

#### Mechanical Data

**Switching Path:** 1,7 mm (.067) ± 0,2 (.008)  
**Maximum Stroke:** 5,2 mm (.205)  
**Spring Force at Switch.Point:** 0,7 N (2.5oz)  
**Spring Force 80% Stroke:** 2,3 N (8.3oz)

#### Materials

**Plunger:** BeCu, gold-plated (or gold-plated with Insulator Cap)  
**Barrel:** Brass, gold-plated  
**Spring:** Steel, gold-plated  
**Receptacle:** Brass, gold-plated

#### Electrical Data

**Current Rating:** 5 A (see page 77)

#### Mounting Hole Size

**with Receptacle:** ø 2,98 - 2,99 mm (.1173 - .1177)  
**without Receptacle:** ø 2,65 mm (.1043)

## Ordering Example

	Series	Tip Material	Tip Style	Tip Diameter (1/100 mm)	Plating	Spring Force at 80% Stroke (dN)	Collar Height (mm)	Type (alternative E)
Test Probe:	SKS	415	306	230	A	23	02	2
Receptacle:	KS-113 23	KS-415 S						
Lamellar Plugs:	SE-415	SE-502	SE-415 KS					

## Available Tip Styles

Material	Tip Style	Plating	Further Versions	
			ø	ø (inch)
0 02		A	5,00 2,30	(.197) (.091)
3 02		A		
3 02		A		
3 03		A		
3 06		A		
3 06		A		
3 06		A	4,00	(.157)
3 19		A		
3 53*		A		
3 56*		A		
3 56*		A		
3 56*		A		

\* Tip Length 9,5 mm (.374)

#### Collar Height and Installation Height

To adjust the Installation Height (Dimension without KS) Test Probes with different Collar Heights are available.

#### Note:

The Receptacle can be used from Grid 4,50 mm (177 Mil) up.

#### Screw-in Version:

see SKS-465 MF and SKS-465 SF on Page 149/150.  
 The Receptacle KS-415 S enables easy changing of the Switching Probe SKS-415 ... 02 E without removing the wiring connection.

#### Tools:

Insertion and Extraction Tools for SKS and KS see Page 118.

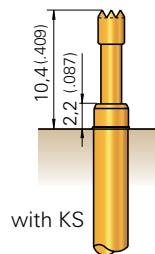

**Grid:**  
 ≥ 3,50 mm  
 ≥ 140 Mil

**Installation Height:** 13,0 mm (.512)  
**Switching Path:** 2,4 mm (.094)

### Mounting and Functional Dimensions

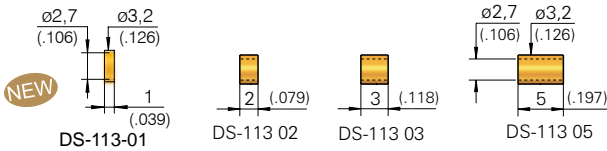
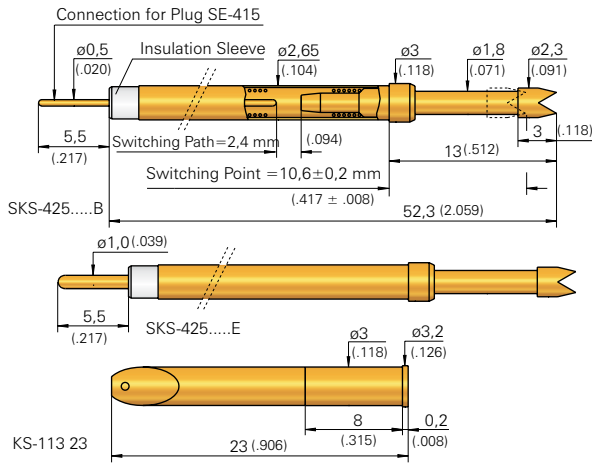

SE-415 for usage with SKS-425 ... B    SE-502 for usage with SKS-425 ... E

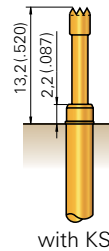
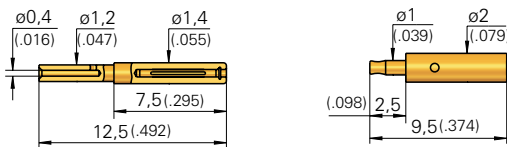

#### Collar Height and Installation Height

The Installation Height of the Tip (Dimension without KS) is determined by the Collar Height.

Collar Height	Installation Height (without Receptacle)
02	13,0 mm (.512)

**Note:**  
 The Receptacle can be used from Grid 4,5 mm (180 Mil) up.

**Tools:**  
 Insertion and Extraction Tools for GKS and KS see Page 118.

#### Mechanical Data

**Switching Path:** 2,4 mm (.094) ± 0,2 (.008)  
**Maximum Stroke:** 8,0 mm (.315)  
**Spring Force at Switch Point:** 0,9 N (3.2oz)  
**Spring Force 80% Stroke:** 2,5 N (9.0oz)

#### Electrical Data

**Current Rating:** 5 A  
 (see page 77)

#### Materials

**Plunger:** BeCu, gold-plated  
 (or gold-plated with Insulator Cap)  
**Barrel:** Brass, gold-plated  
**Spring:** Steel, gold-plated  
**Receptacle:** Brass, gold-plated

#### Mounting Hole Size

**with Receptacle:** ∅ 2,98 - 2,99 mm  
 (.1173 - .1177)  
**without Receptacle:** ∅ 2,65 mm (.1043)

### Ordering Example

Series	Tip Material	Tip Style	Tip Diameter (1/100 mm)	Plating	Spring Force at 80% Stroke (dN)	Collar Height (mm)	Type (alternative E)
SKS	0 = Delrin 3 = BeCu	4 2 5	3 0 4	2 3 0	A	2 5	0 2 B
Receptacle:	KS - 1 1 3 2 3						
Spacers:	DS - 1 1 3 0 2		DS - 1 1 3 0 3		DS - 1 1 3 0 5		
Lamellar Plugs:	SE - 4 1 5		SE - 5 0 2				

e-type® Probes  
 ICT / FCT  
 Bead Probes  
 Fine Pitch  
 Metric Stand.  
 Solderable  
 Short-stroke  
 Flying Probes  
 DKS  
 SKS  
 PKS / PSK  
 RF / Dipole Test Probes  
 HSS  
 Fixture customizing  
 Tools  
 Cable Test Probes

# SKS 419 / 429

Switching Probe with long Stroke, high Stability

## Grid:

≥ 7,5/10,0 mm

≥ 300/400 Mil

Installation Height: 27,0 mm (1.063)

Switching Path: 2,0 mm (.079)

## Mounting and Functional Dimensions

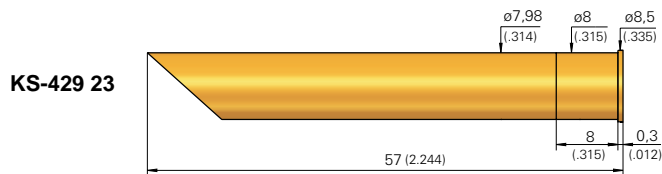
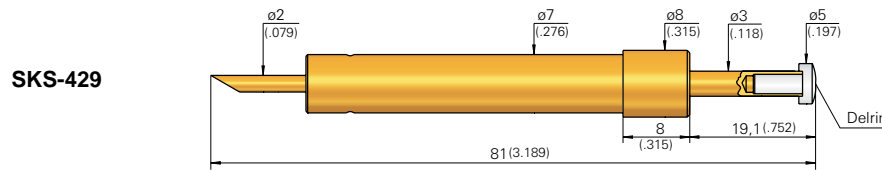
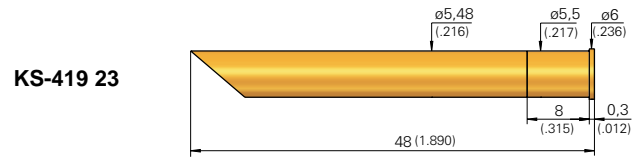
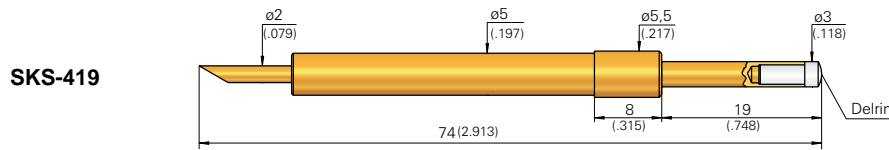

### SKS 419

#### Mechanical Data

**Switching Path:** 2,0 mm (.079) ± 0,2 (.008)  
**Maximum Stroke:** 14,0 mm (.551)  
**Spring Force at Switch.Point:** 2,6 N (9.4oz)  
**Spring Force 80% Stroke:** 5,2 N (18.8oz)  
**Spring Force max. Stroke:** 6,5 N (26.0oz)

#### Electrical Data

**Current Rating:** 5 A  
 (see Page 77)

#### Mounting Hole Size

**with Receptacle:** ø 5,49 mm (.2161)  
**without Receptacle:** ø 5,00 mm (.1969)

#### Materials

**Plunger:** BeCu, gold-plated  
 with Insulator Cap (Delrin)  
**Barrel:** Brass, gold-plated  
**Spring:** Steel, gold-plated  
**Receptacle:** Brass, gold-plated

### SKS 429

#### Mechanical Data

**Switching Path:** 2,0 mm (.079) ± 0,2 (.008)  
**Maximum Stroke:** 16,0 mm (.630)  
**Spring Force at Switch.Point:** 2,9N (10.5oz)  
**Spring Force 80% Stroke:** 6,4 N (23.2oz)  
**Spring Force max. Stroke:** 8,0 N (31.0oz)

#### Electrical Data

**Current Rating:** 5 A  
 (see page 77)

#### Mounting Hole Size

**with Receptacle:** ø 7,99 mm (.3146)  
**without Receptacle:** ø 7,00 mm (.2756)

#### Materials

**Plunger:** BeCu, gold-plated  
 with Insulator Cap (Delrin)  
**Barrel:** Brass, gold-plated  
**Spring:** Steel, gold-plated  
**Receptacle:** Brass, gold-plated

#### Tools:

The special Insertion tools for SKS must be used to install the Switching Probes (see Page 118).

## Ordering Example

	Series	Tip Material 0 = Delrin	Tip Style	Tip Diameter (1/100 mm)	Plating A = Gold	Spring Force at max. Stroke (dN)	Collar Height (mm)								
Test Probe:	SKS	4	1	9	0	0	5	3	0	0	A	6	5	0	8
Test Probe:	SKS	4	2	9	0	0	5	5	0	0	A	8	0	0	8
Receptacle for SKS-419:	KS	4	1	9	2	3									
Receptacle for SKS-429:	KS	4	2	9	2	3									

# Pneumatic Test Probes and Switching Probes

Pneumatic Test Probes are operated with compressed air. Before activation, the plunger is in the home position. On applying the compressed air, the plunger shoots out. The spring inside the barrel retrieves the plunger after releasing the compressed air.

### Application Examples

- Individual contacting of single test points
- Can be controlled individually or in groups
- Contacting of test points, which are difficult to access
- Flexible application as a type of push-rod in Test Fixtures
- Movement of components in explosive areas (instead of Electro-Motors)

### Advantages

- Fixtureless contacting possible
- Later enhancement of test points (layout change) possible
- Individual set-up of the test procedures possible
- Quick set-up of flexible test requirements
- In the case of a small number of test points, cheap alternative to a Test Fixture
- High level of contacting accuracy due to short installation height and stationary basic set-up

1. Compressed air 0 bar, Plunger at home-position



2. Compressed air 6 bar, Plunger shoots out, working-position



# Pneumatic Test Probes / Switching Probes

PKS-355 M	84
PKS-388 M	85
PSK-350 M Pneumatic Switching Probe	86
PKS-171	87
PKS-200	88
PKS-220	89
PKS-299	90
PKS-300	91
PKS-399	92
PKS-420	93
PKS Accessories	94+95



# PKS 355 M

Screw-in Pneumatic Test Probe

Grid:

≥ 3,5 mm

≥ 140 Mil

Installation Height (with KS): 5,7 mm (.224)

Recommended Stroke: 6,0 mm (.236)

## Mounting and Functional Dimensions

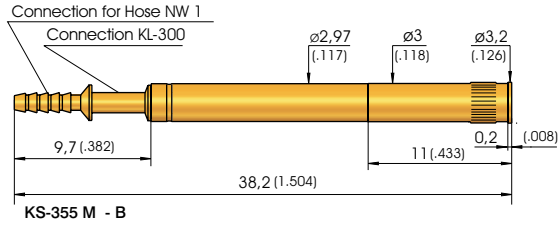
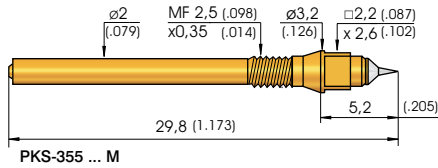

### Assembly PKS-355 M with quick-exchange System KS-355 M - B

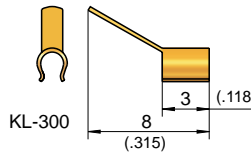
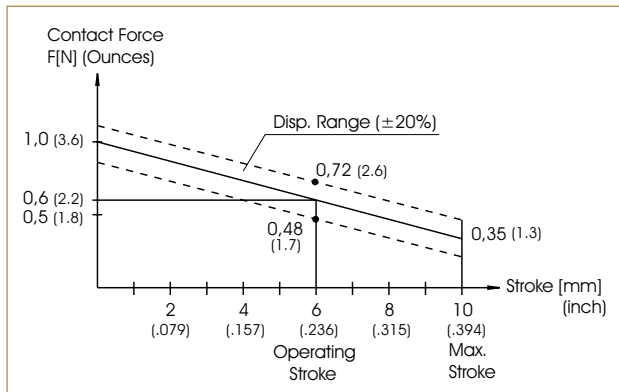
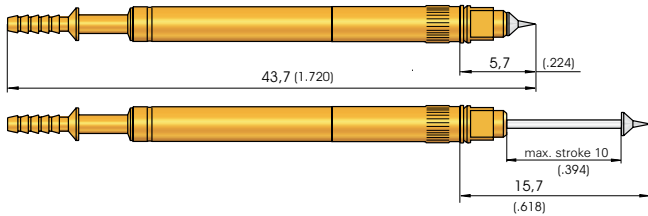

## Available Tip Styles

Material	Tip Style	Plating	Further Versions	
			∅	∅ (inch)
2 01 ***		R	∅ 1,50 (.059)	
2 04 **		R	∅ 1,30 (.051)	
2 06 **		A	∅ 1,00 (.039)	
2 33 **		A	∅ 1,30 (.051)	
2 91 *		A	∅ 1,00 (.039)	

Collar Diameter:

\* = 1,20 mm (.047)

\*\* = 1,30 mm (.051)

\*\*\* = 1,50 mm (.059)

\*\*\*\* = 1,80 mm (.071)

### Note:

Electrical and pneumatic connections are carried out only once at the time of customizing. The exchangeable unit PKS-355 M is screwed into the ready-wired and pneumatically connected up Receptacle KS-355 M-B. The Test Probe can be changed from above. The Test Fixture must not be opened. The wiring and pneumatic connections are not affected.

### Note:

Pneumatic Accessories and general Instructions see Page 94/95.

### Note to PKS-355 M and KS-355 M-B:

PKS-355 M are screwed into KS-355 M-B using special tools (see Page 170/171).

Recommended Screw-in Torque:  
Min.: 10 Ncm / Max.: 20 Ncm

### Mechanical Data

**Working Stroke:** 6,0 mm (.236)  
**Maximum Stroke:** 10,0 mm (.394)  
**Cont. Force at Work.Stroke:** 0,6 N (2.2oz)  
**Operating Medium:** Compressed Air (filtered, oil-free)  
**Operating Pressure:** 6 bar (86 psi)

### Materials

**Plunger:** Steel, rhodium- or gold-plated  
**Barrel:** Brass, gold-plated  
**Restoring Spring:** Steel, gold-plated  
**Receptacle:** Brass, gold-plated  
**O-Rings:** Perbunan

### Electrical Data

**Current Rating:** 1 - 2 A  
**R<sub>i</sub> typical:** < 30 mΩ

### Mounting Hole Size for Receptacle

**in CEM 1:** ∅ 3,15 - 3,17 mm (.1240-.1248)  
**in FR 4:** ∅ 3,17 - 3,18 mm (.1248-.1252)

## Ordering Example

Series	Tip Material	Tip Style	Tip Diameter (1/100 mm)	Plating	Spring Force (dN)	Collar Height (mm)	Type
	2 = Steel			A = Gold R = Rhodium			

Test Probe:

PKS 355 2 01 150 R 06 02 M

Receptacle for PKS-355 M:

KS - 355 M - B

Clip Connection with Solder Terminal for KS-355:

KL - 300

**Grid:**  
 ≥ 5,08 mm  
 ≥ 200 Mil

**Installation Height (with KS):** 6,1 mm (.240)  
**Recommended Stroke:** 12,0 mm (.472)

### Mounting and Functional Dimensions

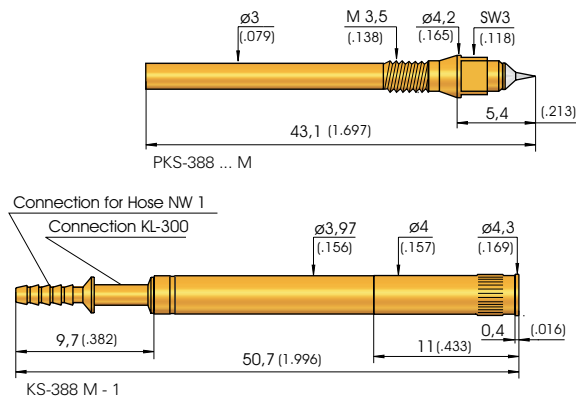

### Assembly PKS-388 M with quick-exchange System KS-388 M-1

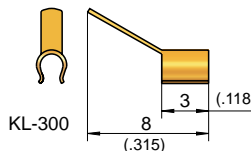
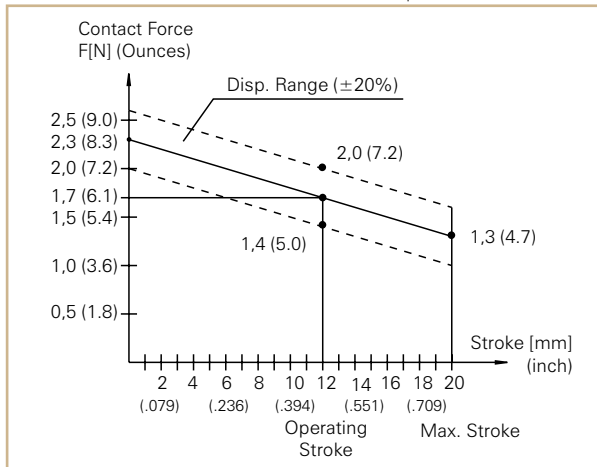
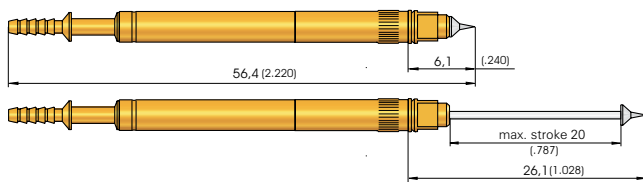

### Available Tip Styles

Material	Tip Style	Plating	Further Versions	
			Ø	Ø (inch)
2	01**	R	Ø 2,00 (.079)	
3	02	A	Ø 2,50 (.098)	
2	04**	R	Ø 1,30 (.051)	2,00 (.079)
2	15**	A	Ø 2,00 (.079)	

\* pressed-in HM-Tip, Installation Height with KS: 7,1 mm (.280)  
 \*\* Collar Diameter: 2,0 mm (.0799)

### Available Tip Styles

#### Special Versions without Collar

Material	Tip Style	Plating	Further Versions	
			Ø	Ø (inch)
2	01***	R	Ø 1,50 (.059)	
2	04***	R	Ø 1,50 (.059)	
3	05***	A	Ø 1,30 (.051)	

\*\*\* Shaft Diameter 1,50 mm (.059)

#### Note:

For High-Current Applications up to 10 A order with Special Designation "MH".

#### Note:

Electrical and pneumatic connections are carried out only once at the time of customizing. The exchangeable unit PKS-388 M is screwed into the ready wired and pneumatically connected up Receptacle KS-388 M-1. The Test Probe can be changed from above. The Test Fixture must not be opened. The wiring and pneumatic connections are not affected. Pneumatic Accessories and general Instructions see Page 94/95.

**Note to PKS-388 M and KS-388 M-1:** PKS-388 M are screwed into KS-388 M-1 using special tools (see Page 170/171).

Recommended Screw-in Torque: Min.: 10 Ncm / Max.: 20 Ncm

#### Mechanical Data

**Working Stroke:** 12,0 mm (.472)  
**Maximum Stroke:** 20,0 mm (.787)  
**Cont. Force at Work. Stroke:** 1,7 N (6.1oz)  
**Operating Medium:** Compressed Air (filtered, oil-free)  
**Operating Pressure:** 6 bar (86 psi)

#### Materials

**Plunger:** Steel or BeCu, rhodium- or gold-plated  
**Barrel:** Brass, gold-plated  
**Restoring Spring:** Steel, gold-plated  
**Receptacle:** Brass, gold-plated  
**O-Rings:** Perbunan

#### Electrical Data

**Current Rating:** 2 - 3 A  
**R<sub>i</sub> typical:** < 30 mΩ

#### Mounting Hole Size

**in CEM 1 and FR 4:** Ø 4,00 - 4,02 mm (.1575 - .1583)

### Ordering Example

Series	Tip Material 2 = Steel 3 = BeCu	Tip Style	Tip Diameter (1/100 mm)	Plating A = Gold R = Rhodium	Spring Force (dN)	Collar Height (mm)	Type
--------	---------------------------------------	-----------	----------------------------	------------------------------------	----------------------	-----------------------	------

Test Probe:

PKS 388 2 01 2 00 R 17 02 M

Receptacle for PKS-388:

KS - 388 M - 1

Clip Connection with Solder Terminal:

KL - 300

# PSK 350 M

Screw-in Pneumatic Switching Probe (opener)

**Grid:**

≥ 3,5 mm

≥ 140 Mil

**Installation Height (with KS):** 5,7 mm (.224)

**Switching Path:** 6,0 mm (.236)

## Mounting and Functional Dimensions

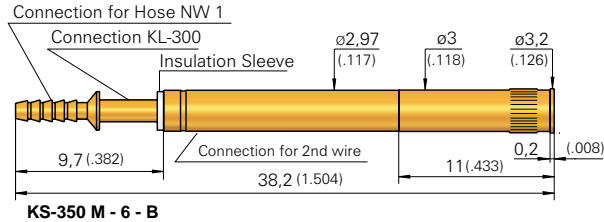
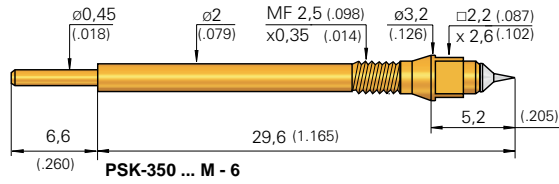

### Assembly PSK-350 M with quick-exchange System KS-350 M-6-B

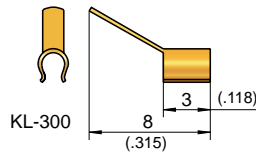
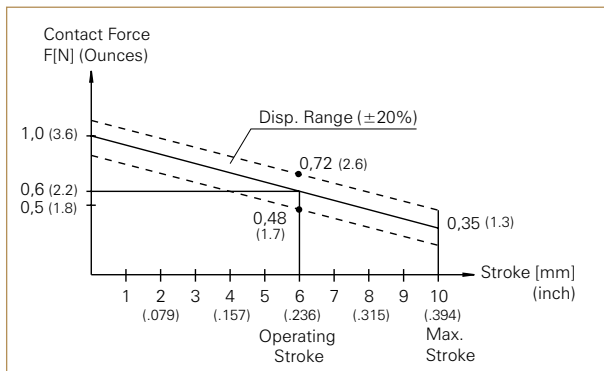
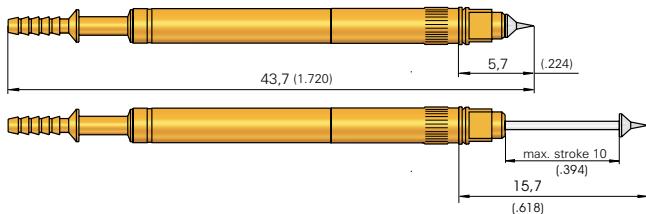

## Available Tip Styles

Material	Tip Style	Plating	Further Versions	
			∅	∅ (inch)
2 01 ***		R	∅ 1,50 (.059)	
3 02		A	∅ 2,00 (.079)	
2 04 **		R	∅ 1,30 (.051)	
2 06 **		A	∅ 1,00 (.039)	
2 33 **		A	∅ 1,30 (.051)	
2 91 *		A	∅ 1,00 (.039)	

Collar Diameter:

\* = 1,20 mm (.047)

\*\* = 1,30 mm (.051)

\*\*\* = 1,50 mm (.059)

\*\*\*\* = 1,80 mm (.071)

### Functionality:

The pneumatic Switching Probe PSK 350 is designed as an „opener“. In the home position there is an electric contact between the Pneumatic Probe and the Terminal of the Receptacle. After 6 mm (.236) Stroke this connection is interrupted.

### Note:

Electrical and pneumatic connections are carried out only once at the time of customizing. The exchangeable unit PSK-350 M is screwed into the ready wired and pneumatically connected up Receptacle KS-350 M-6-B. The Test Probe can be changed from above. The Test Fixture must not be opened. The wiring and pneumatic connections are not affected.

Pneumatic Accessories and general Instructions see Page 94/95).

**Note to PSK-350 M and KS-350 M-6-B:** PSK-350 M are screwed into KS-350 M-6-B using special tools (see Page 170/171).

Recommended Screw-in Torque:  
Min.: 10 Ncm / Max.: 20 Ncm

### Mechanical Data

**Switch. Path/Work. Stroke:** 6,0 mm (.236)

**Maximum Stroke:** 10,0 mm (.394)

**Cont. Force at Work.Stroke:** 0,6 N (2.2oz)

**Operating Medium:** Compressed Air (filtered, oil-free)

**Operating Pressure:** 6 bar (86 psi)

### Materials

**Plunger:** Steel, rhodium- or gold-plated

**Barrel:** Brass, gold-plated

**Restoring Spring:** Steel, gold-plated

**Receptacle:** Brass, gold-plated

**O-Rings:** Perbunan

**Insulation:** Peek

**Terminal:** Brass, gold-plated

### Electrical Data

**Current Rating:** 1 - 2 A

**R<sub>i</sub> typical:** < 30 mΩ

### Mounting Hole Size for Receptacle

**in CEM 1:** ∅ 3,15 - 3,17 mm (.1240-.1248)

**in FR 4:** ∅ 3,17 - 3,18 mm (.1248-.1252)

## Ordering Example

Series	Tip Material	Tip Style	Tip Diameter (1/100 mm)	Plating	Spring Force (dN)	Collar Height (mm)	Type
	2 = Steel 3 = CuBe			A = Gold R = Rhodium			

Test Probe:

PSK 350 2 04 130 R 06 02 M-6

Receptacle for PSK-350 ... M-6:

KS-350 M-6-B

Clip-Connection with Solder Terminal for KS-350:

KL-300

**Grid:**  
 ≥ 1,91 mm  
 ≥ 75 Mil

**Installation Height:** 5,5 mm (.217)  
**Recommended Stroke:** 6,0 mm (.236)

### Mounting and Functional Dimensions

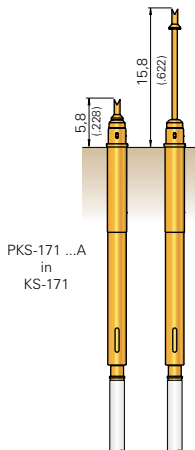
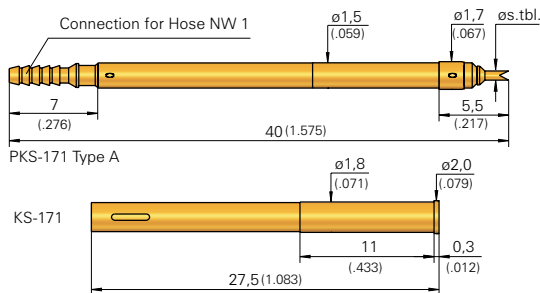

Available Tip Styles					
Material	Tip Style	Tip Diameter	Plating	Further Versions	
				Ø	Ø (inch)
2	04*	Ø 1,00 (.039)	A		
2	14*	Ø 0,50 (.020)	A		
3	19	Ø 1,50 (.059)	A		
2	91*	Ø 1,00 (.039)	A		

\* Diameter of Collar: 1,3 mm (.051)

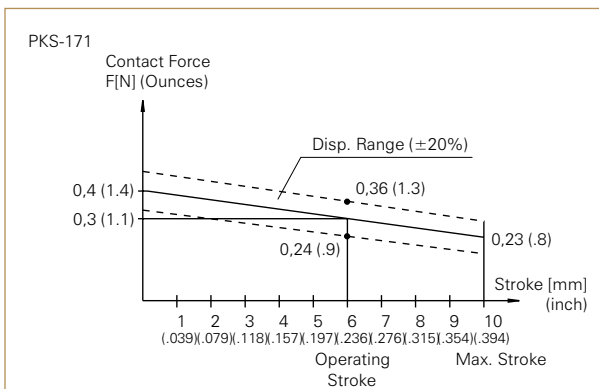
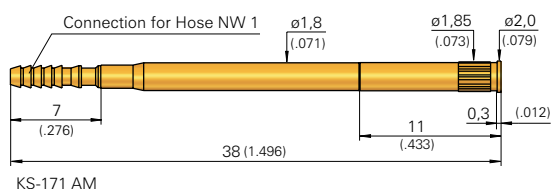
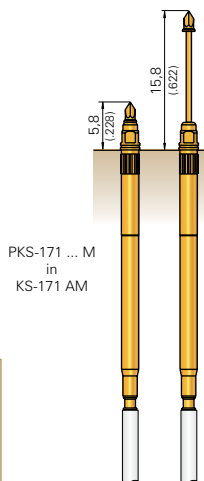
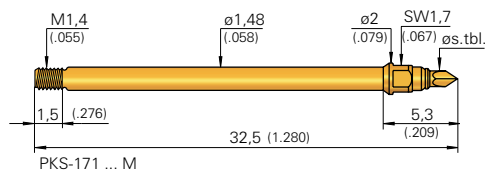

**Note to PKS-171 M and KS-171 AM:**  
 PKS-171 M are screwed into KS-171 AM using special tools (see Page 170/171).  
 Recommended Screw-in Torque:  
 Min.: 2 Ncm / Max.: 3 Ncm

**Warning:**  
 Do not solder the cable to the crimp points of the Receptacle.

**Note:**  
 The assembly in Grid 1,91 mm (75 Mil) is only possible up to a double row, and then only without use of Receptacles.

**Note:**  
 The Receptacles can be used from Grid 2,54 mm (100 Mil) up.

**Note:**  
 Pneumatic Accessories and general Instructions see Page 94/95.

**Mechanical Data**  
**Switch. Path/Work. Stroke:** 6,0 mm (.236)  
**Maximum Stroke:** 10,0 mm (.394)  
**Cont. Force at Work.Stroke:** 0,3 N (1.1oz)  
**Operating Medium:** Compressed Air (filtered, oil-free)  
**Operating Pressure:** 6 bar (86 psi)

**Materials**  
**Plunger:** Steel, gold-plated  
**Barrel:** Brass, gold-plated  
**Restoring Spring:** Steel, gold-plated  
**Receptacle:** Brass, gold-plated  
**O-Rings:** Perbunan

**Electrical Data**  
**Current Rating:** 1 - 2 A  
**R<sub>i</sub> typical:** < 30 mΩ

**Mounting Hole Size**  
**with Receptacle KS-171:** Ø 1,79 - 1,80 mm (.0705 - .0709)  
**with Receptacle KS-171 AM:** Ø 1,80 - 1,82 mm (.0709 - .0717)  
**without Receptacle:** Ø 1,49 mm (.0587)

### Ordering Example

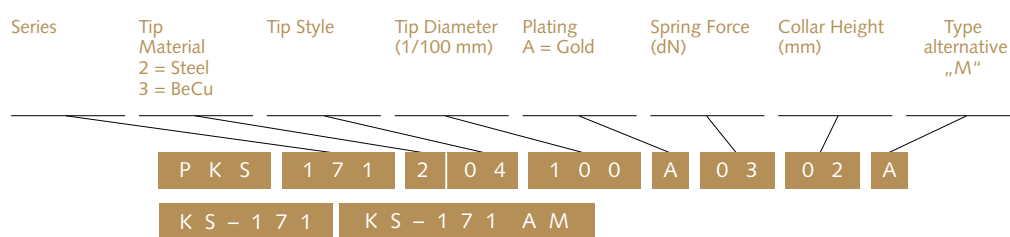

e-type® Probes  
 ICT / FCT  
 Bead Probes  
 Fine Pitch  
 Metric Stand.  
 Solderable  
 Short-stroke  
 Flying Probes  
 DKS  
 SKS  
 PKS / PSK  
 RF / Dipole Test Probes  
 HSS  
 Fixture customizing  
 Tools  
 Cable Test Probes

# PKS 200

Pneumatic Test Probe

## Grid:

≥ 2,54 mm

≥ 100 Mil

Installation Height: 5,5 mm (.217)

Recommended Stroke: 6,0 mm (.236)

## Mounting and Functional Dimensions

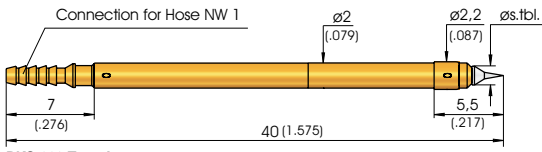

PKS-200 Type A

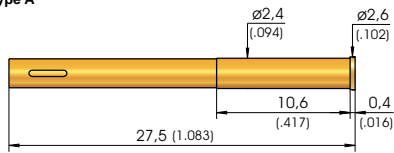

KS-200

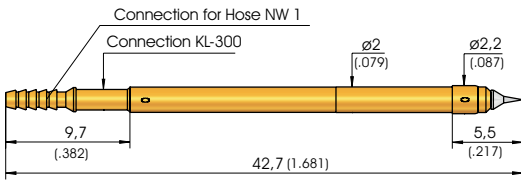

PKS-200 Type B

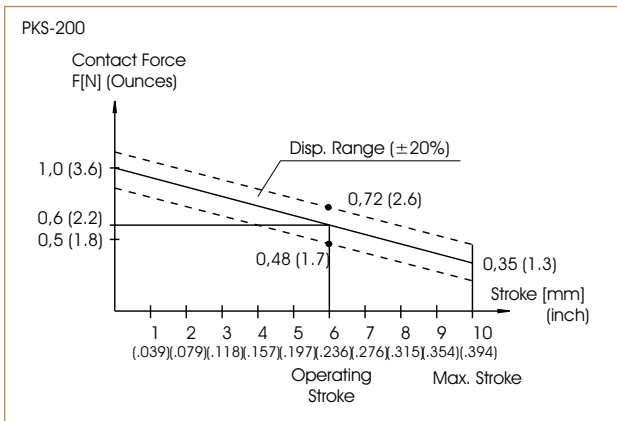
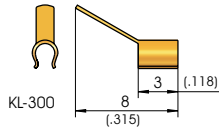

### Mechanical Data

**Working Stroke:** 6,0 mm (.236)  
**Maximum Stroke:** 10,0 mm (.394)  
**Cont. Force at Work.Stroke:** 0,6 N (2.2oz)  
**Operating Medium:** Compressed Air (filtered, oil-free)  
**Operating Pressure:** 6 bar (86 psi)

### Materials

**Plunger:** Steel, rhodium- or gold-plated  
**Barrel:** Brass, gold-plated  
**Restoring Spring:** Steel, gold-plated  
**Receptacle:** Brass, gold-plated  
**O-Rings:** Perbunan

### Electrical Data

**Current Data:** 1 - 2 A  
**R<sub>i</sub> typical:** < 30 mΩ

### Mounting Hole Size

**with Receptacle:** ø 2,38 - 2,39 mm (.0937 - .0941)  
**without Receptacle:** ø 2,00 mm (.0787)

## Available Tip Styles

Material	Tip Style	Plating	Further Versions	
			ø	ø (inch)
2 01 ***		R	ø 1,50 (.059)	
2 04 **		R	ø 1,30 (.051)	
2 06 **		A	ø 1,00 (.039)	
2 33 **		A	ø 1,30 (.051)	
2 91 *		A	ø 1,00 (.039)	

### Collar Diameter:

\* = 1,20 mm (.047)

\*\*\* = 1,50 mm (.059)

\*\* = 1,30 mm (.051)

\*\*\*\* = 1,80 mm (.071)

### Warning:

Do not solder the cable to the crimp points of the Receptacle.

### Note:

The assembly in Grid 2,54 mm (100 Mil) is only possible up to a double row, and then only without use of Receptacles and KL-300. Then pre-wired PKS-200 ... V (with flexible Wire AWG 34, Length 500 mm (20.000")) must be used.

### Note:

The Receptacles and KL-300 can be used from Grid 3,00 mm (120 Mil) up.

### Note:

Pneumatic Accessories and general Instructions see Page 94/95.

## Ordering Example

Series	Tip Material	Tip Style	Tip Diameter (1/100 mm)	Plating	Spring Force (dN)	Collar Height (mm)	Type (alternative B or V)
PKS	2 = Steel	01	150	R = Rhodium	06	02	A

Test Probe:

PKS 200 2 01 150 R 06 02 A

Receptacle for PKS-200:

KS - 200

Clip Connection with Solder Terminal for Series 200:

KL - 300

**Grid:**  
 ≥ 2,54 mm  
 ≥ 100 Mil

**Installation Height:** 5,5 mm (.217)  
**Recommended Stroke:** 6,0 mm (.236)

### Mounting and Functional Dimensions

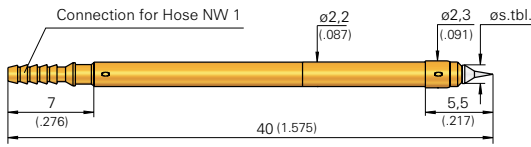

PKS-220 Type A

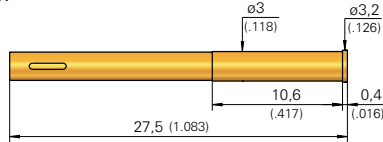

KS-220

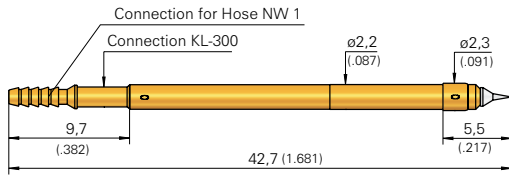

PKS-220 Type B

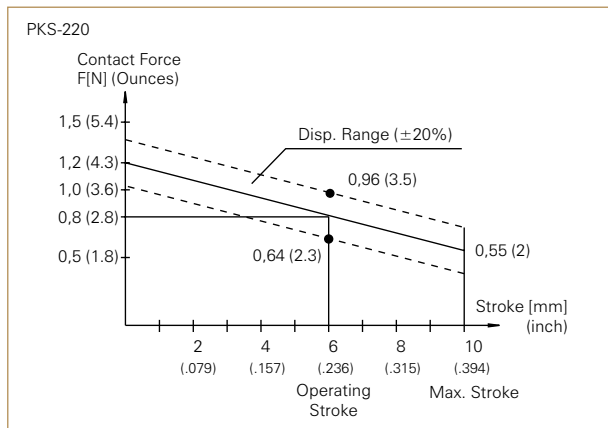
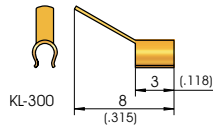

#### Mechanical Data

**Working Stroke:** 6,0 mm (.236)  
**Maximum Stroke:** 10,0 mm (.394)  
**Cont. Force at Work.Stroke:** 0,8 N (2.9oz)  
**Operating Medium:** Compressed Air (filtered, oil-free)  
**Operating Pressure:** 6 bar (86 psi)

#### Electrical Data

**Current Data:** 2 - 3 A  
**R<sub>i</sub> typical:** < 30 mΩ

#### Materials

**Plunger:** Steel or BeCu, rhodium- or gold-plated  
**Barrel:** Brass, gold-plated  
**Restoring Spring:** Steel, gold-plated  
**Receptacle:** Brass, gold-plated  
**O-Rings:** Perbunan

#### Mounting Hole Size

**with Receptacle:** ø 2,98 - 2,99 mm (.1173 - .1177)  
**without Receptacle:** ø 2,20 mm (.0866)

### Available Tip Styles

Material	Tip Style	Plating	Further Versions	
			ø	ø (inch)
2 01 **		R	ø 1,50 (.059)	
3 03		R	ø 2,00 (.079)	
2 04 *		R	ø 1,30 (.051)	
2 05 ***		A	ø 1,00 (.039)	
2 06		A	ø 2,50 (.098)	
3 06		R	ø 2,00 (.079)	
2 07		R	ø 2,00 (.079)	
2 91 ** **		N	ø 1,00 (.039)	

**Collar Diameter:**  
 \* = 2,00 mm (.079)      \*\* = 1,50 mm (.059)  
 \*\*\* = 1,30 mm (.051)      \*\*\*\* = 1,20 mm (.047)

#### Warning:

Do not solder the cable to the crimp points of the Receptacle.

#### Note:

The assembly in Grid 2,54 mm (100 Mil) is only possible up to a double row, and then only without use of Receptacles and KL-300. The Receptacle and KL-300 can be used from Grid 3,5 mm (140 Mil) up.

#### Note:

Pneumatic Accessories and general Instructions see Page 94/95.

### Ordering Example

Series	Tip Material	Tip Style	Tip Diameter (1/100 mm)	Plating	Spring Force (dN)	Collar Height (mm)	Type (alternative B)
PKS	2 = Steel	01	150	A = Gold	08	02	A

Test Probe:

PKS 220 2 01 150 R 08 02 A

Receptacle for PKS-220:

KS - 220

Clip Connection with Solder Terminal for Series 220:

KL - 300



# PKS 299

Pneumatic Test Probe

## Grid:

≥ 3,50 mm

≥ 140 Mil

Installation Height: 5,5 mm (.217)

Recommended Stroke: 12,0 mm (.472)

## Mounting and Functional Dimensions

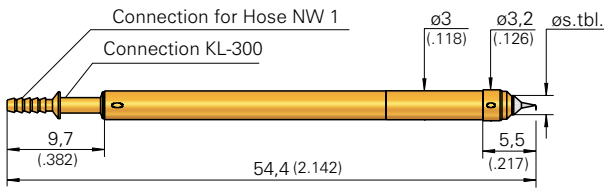

PKS-299 Type B

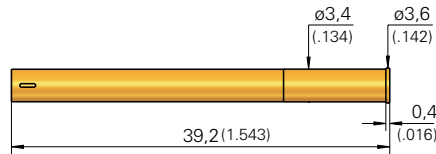

KS-299

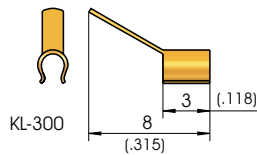

KL-300

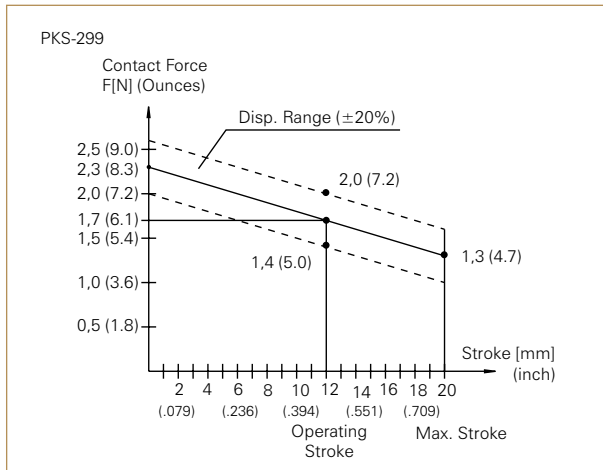

## Available Tip Styles

Material	Tip Style	Plating	Further Versions	
			∅	∅ (inch)
2	01**	R		
3	02	A		
2	04**	R	2,00	(.079)
2	15**	A		

\* pressed-in HM-Tip, Installation Height 6,5 mm (.256)

\*\* Collar Diameter: 2,0 mm (.079)

## Available Tip Styles

### Special Versions without Collar

Material	Tip Style	Plating	Further Versions	
			∅	∅ (inch)
2	01***	R		
2	04***	R		
3	05***	A		

\*\*\* Shaft Diameter: 1,50 mm (.059)

## Warning:

Do not solder the cable to the crimp points of the Receptacle.

## Note:

For High-Current Applications up to 10 A, order with Special Designation „BH“ (Terminal „B“).

## Note:

The Receptacle can be used from Grid 4,00 mm (160 Mil) up.

## Note:

Pneumatic Accessories and general Instructions see Page 94/95.

## Mechanical Data

**Working Stroke:** 12,0 mm (.472)  
**Maximum Stroke:** 20,0 mm (.787)  
**Cont. Force at Work.Stroke:** 1,7 N (6.1oz)  
**Operating Medium:** Compressed Air (filtered, oil-free)  
**Operating Pressure:** 6 bar (86 psi)

## Materials

**Plunger:** Steel or BeCu, rhodium- or gold-plated  
**Barrel:** Brass, gold-plated  
**Restoring Spring:** Steel, gold-plated  
**Receptacle:** Brass, gold-plated  
**O-Rings:** Perbunan

## Electrical Data

**Current Rating:** 2 - 3 A (see Note below)  
**R<sub>i</sub> typical:** < 30 mΩ

## Mounting Hole Size

**with Receptacle:** ∅ 3,38 - 3,39 mm (.1331 - .1335)  
**without Receptacle:** ∅ 3,00 mm (.1181)

## Ordering Example

Series	Tip Material	Tip Style	Tip Diameter (1/100 mm)	Plating	Spring Force (dN)	Collar Height (mm)	Type (alternative B or BH)
2 = Steel	3 = BeCu	A = Gold	R = Rhodium				

Test Probe:

P K S 2 9 9 2 0 1 2 0 0 R 1 7 0 2 B

Test Probe for usage up to 10 A:

P K S 2 9 9 2 0 4 1 3 0 R 1 7 0 2 BH

Receptacle for PKS-299:

K S - 2 9 9

Clip connection with Solder Terminal:

K L - 3 0 0

**Grid:**  
 ≥ 3,50 mm  
 ≥ 140 Mil

**Installation Height:** 5,5 mm (.217)  
**Recommended Stroke:** 6,0 mm (.236)

### Mounting and Functional Dimensions

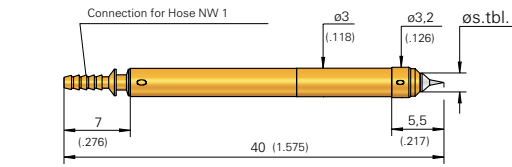

PKS-300 Type A

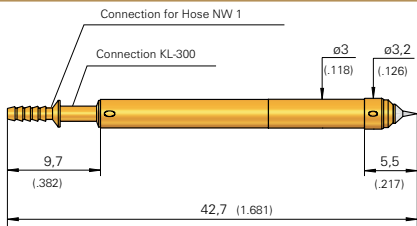
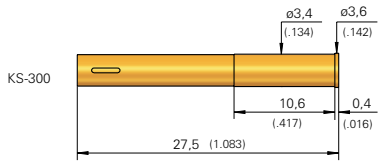

PKS-300 Type B

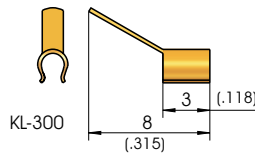
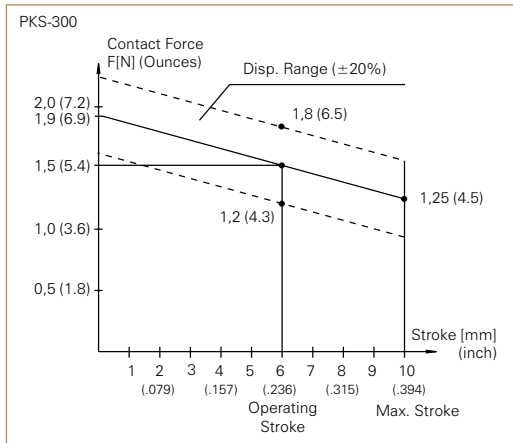

### Available Tip Styles

Material	Tip Style	Plating	Further Versions	
			∅	∅ (inch)
2 01 **		R		
2 04 **		R	2,00	(.079)
2 05 **		R	1,30	(.051)
2 06 **		A	2,50 3,50	(.098) (.138)
2 15*		A		
2 33 **		A		
2 91 **		A		

\* pressed-in HM-Tip, Installation Height 6,5 mm (.256)  
 \*\* Collar Diameter: 2,0 mm (.079)

#### Mechanical Data

**Working Stroke:** 6,0 mm (.236)  
**Maximum Stroke:** 10,0 mm (.394)  
**Contact Force at Work.Stroke:** 1,1 N (4.0oz) or 1,5 N (5.4oz)  
**Operating Medium:** Compressed Air (filtered, oil-free)  
**Operating Pressure:** 6 bar (86 psi)

#### Materials

**Plunger:** Steel, rhodium- or gold-plated  
**Barrel:** Brass, gold-plated  
**Restoring Spring:** Steel, gold-plated  
**Receptacle:** Brass, gold-plated  
**O-Rings:** Perbunan

#### Electrical Data

**Current Rating:** 2 - 3 A (up to 10 A see Note below)  
**R<sub>i</sub> typisch:** < 30 mΩ

#### Mounting Hole Size

**with Receptacle:** ∅ 3,38 - 3,39 mm (.1331 - .1335)  
**without Receptacle:** ∅ 3,00 mm (.1181)

#### Warning:

Do not solder the cable to the crimp points of the Receptacle.

#### Note:

For High-Current Applications up to 10 A, order with Special Designation „AH“ (Terminal „A“) resp. „BH“ (Terminal „B“).

#### Note:

The Receptacle can be used from Grid 4,00 mm (160 Mil) up.

#### Note:

Pneumatic Accessories and general Instructions see Page 94/95.

#### \*\*\* Note:

Tip 15, 01, 91 F = 1,1 N (4.0oz)  
 Tip 04, 05, 06, 33 F = 1,5 N (5.4oz)

### Ordering Example

Series	Tip Material	Tip Style	Tip Diameter (1/100 mm)	Plating	Spring Force (dN)	Collar Height (mm)	Type (alternative AH, B, BH)
2 = Steel				A = Gold R = Rhodium			

Test Probe:

PKS 300 2 01 200 R 11 02 A

Test Probe for usage up to 10 A:

PKS 300 2 06 130 A 15 02 AH

Receptacle for PKS-300:

KS - 300

Clip Connection with Solder Terminal for Series 300:

KL - 300

# PKS 399

Pneumatic Test Probe

## Grid:

≥ 4,50 mm

≥ 177 Mil

Installation Height: 5,5 mm (.217)

Recommended Stroke: 12,0 mm (.472)

## Mounting and Functional Dimensions

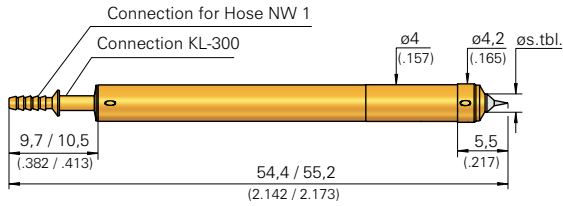

PKS-399 Type 1: with Connection for Hose NW 1

PKS-399 Type 2: with Connection for Hose NW2 (lengths see 2nd value)

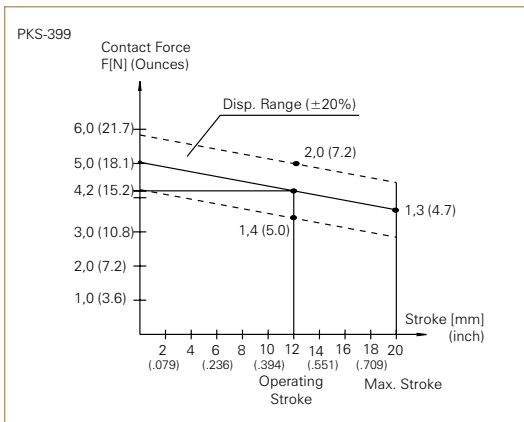
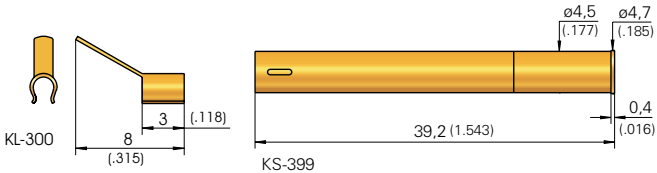

## Available Tip Styles

Material	Tip Style	Plating	Further Versions	
			∅	∅ (inch)
2	01**	R	∅ 2,00 (.079)	
3	02	A	∅ 2,50 (.098)	
2	04**	R	∅ 1,30 (.051)	2,00 (.079)
2	15*	A	∅ 2,00 (.079)	

\* pressed-in HM-Tip, Installation Height 6,5 mm (.256)

\*\* Collar Diameter: 2,0 mm (.079)

## Available Tip Styles

### Special Versions without Collar

Material	Tip Style	Plating	Further Versions	
			∅	∅ (inch)
2	01***	R	∅ 1,50 (.059)	
2	04***	R	∅ 1,50 (.059)	
3	05***	A	∅ 1,30 (.051)	

\*\*\* Shaft Diameter: 1,50 mm (.059)

### \*\*\*\* Note:

Tip 01, 15 F = 3,7 N (13.4oz)  
 Tip 02, 04, 05 F = 4,2 N (15.2oz)

### Warning:

Do not solder the cable to the crimp points of the Receptacle.

### Mechanical Data

**Working Stroke:** 12,0 mm (.472)  
**Maximum Stroke:** 20,0 mm (.787)  
**Cont. Force at Work.Stroke:** 3,7 N (13.4oz) or 4,2 N (15.2oz)\*\*\*\*  
**Operating Medium:** Compressed Air (filtered, oil-free)  
**Operating Pressure:** 6 bar (86 psi)

### Materials

**Plunger:** Steel or BeCu, rhodium- or gold-plated  
**Barrel:** Brass, gold-plated  
**Restoring Spring:** Steel, gold-plated  
**Receptacle:** Brass, gold-plated  
**O-Rings:** Perbunan

### Note:

For High-Current Applications up to 10 A, order with Special Designation „1H“ (Terminal „1“) resp. „2H“ (Terminal „2“).

### Note:

The Receptacle can be used from Grid 5,08 mm (200 Mil) up.

### Electrical Data

**Current Rating:** 2 - 3 A (up to 10 A see Note below)  
**R<sub>i</sub> typisch:** < 30 mΩ

### Mounting Hole Size

**with Receptacle:** ∅ 4,48 - 4,49 mm (.1764 - .1768)  
**without Receptacle:** ∅ 4,00 mm (.1575)

### Note:

Pneumatic Accessories and general Instructions see Page 94/95.

## Ordering Example

Series	Tip Material	Tip Style	Tip Diameter (1/100 mm)	Plating	Spring Force (dN)	Collar Height (mm)	Type (alternative 2 or 2H)
PKS	2 = Steel	01	2,00	R = Rhodium	3,7	0,2	1

Test Probe:

PKS 399 2 01 200 R 37 02 1

Test Probe for usage up to 10 A:

PKS 399 2 04 130 R 42 02 1H

Receptacle for PKS-399:

KS - 399

Clip Connection with Solder Terminal for Type 1:

KL - 300

**Grid:**  
 ≥ 4,50 mm  
 ≥ 177 Mil

**Installation Height:** 5,5 mm (.217)  
**Recommended Stroke:** 6,0 mm (.236)

### Mounting and Functional Dimensions

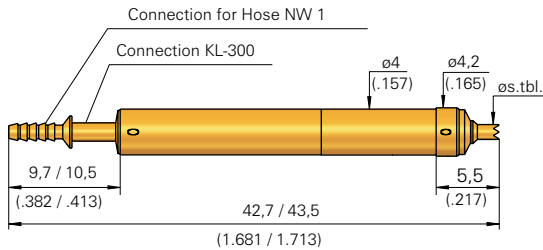

PKS-420 Type 1: with Connection for Hose NW 1

PKS-420 Type 2: with Connection for Hose NW2 (lengths see 2nd value)

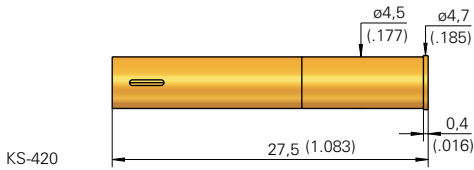

KS-420

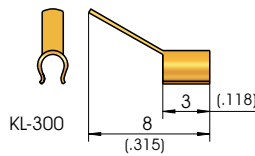
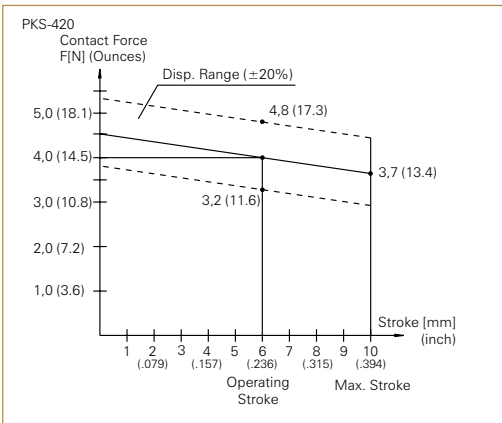

### Available Tip Styles

Material	Tip Style	Tip Diameter	Plating	Further Versions	
				Ø	Ø (inch)
2	01**	Ø 2,00 (.079)	R		
2	04**	Ø 1,30 (.051)	R	2,00	(.079)
2	05	Ø 2,50 (.098)	R	1,30**	(.051)
2	06**	Ø 1,30 (.051)	A	2,50	(.098)
2	15*	Ø 2,00 (.079)	A	3,50	(.138)
2	33**	Ø 1,30 (.051)	A		
2	91**	Ø 1,30 (.051)	A		

\* pressed-in HM-Tip, Installation Height 6,5 mm (.256)  
 \*\* Collar Diameter: 2,0 mm (.079)

#### Warning:

Do not solder the cable to the crimp points of the Receptacle.

#### Note:

For High-Current Applications up to 10 A, order with Special Designation „1H“ (Terminal „1“) resp. „2H“ (Terminal „2“).

#### Note:

The Receptacle can be used from Grid 5,08 mm (200 Mil) up.

#### Note:

Pneumatic Accessories and general Instructions see Page 94/95.

#### \*\*\* Note:

Tip 15, 01, 91 F = 3,7 N (13.4oz)  
 Tip 04, 05, 06, 33 F = 4,2 N (15.2oz)

#### Mechanical Data

**Working Stroke:** 6,0 mm (.236)  
**Maximum Stroke:** 10,0 mm (.394)  
**Cont. Force at Work.Stroke:** 3,7 N (13.4oz) or 4,2 N (15.2oz)\*\*  
**Operating Medium:** Compressed Air (filtered, oil-free)  
**Operating Pressure:** 6 bar (86 psi)

#### Materials

**Plunger:** Steel, rhodium- or gold-plated  
**Barrel:** Brass, gold-plated  
**Restoring Spring:** Steel, gold-plated  
**Receptacle:** Brass, gold-plated  
**O-Rings:** Perbunan

#### Electrical Data

**Current Rating:** 2 - 3 A (up to 10 A see Note below)  
**R<sub>i</sub> typisch:** < 30 mΩ

#### Mounting Hole Size

**with Receptacle:** Ø 4,48 - 4,49 mm (.1764 - .1768)  
**without Receptacle:** Ø 4,00 mm (.1575)

### Ordering Example

	Series	Tip Material 2 = Steel	Tip Style	Tip Diameter (1/100 mm)	Plating A = Gold R = Rhodium	Spring Force (dN)	Collar Height (mm)	Type (alternative 2 or 2H)
Test Probe:	PKS	4	20	2	06	130	A	42021
Test Probe for usage up to 10 A:	PKS	4	20	2	04	130	R	42021H
Receptacle for PKS-420:	KS	4	20					
Clip Connection with Solder Terminal for Type 1:	KL	3	00					

Pneumatic Test Probes can be actuated and controlled individually or in groups.

## Possible set-up and layout:

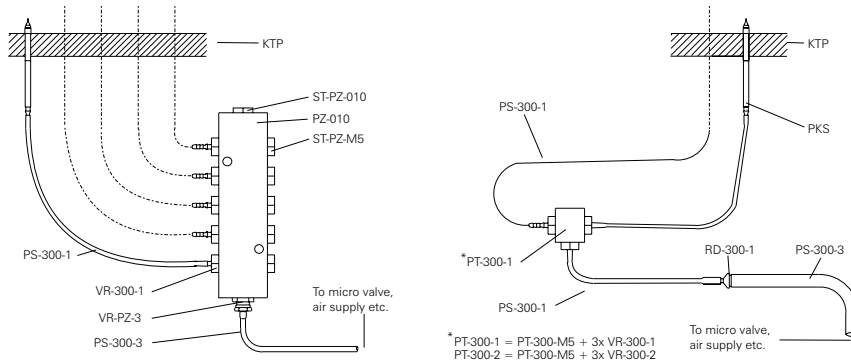

## General Notes:

To connect up Pneumatic Probes, a compressed-air hose with a normal width of 1 mm (NW1) or 2 mm (NW2) is necessary. A range of adapters (see table below) are offered to establish air feed lines from commercially available compressed-air hose NW3 or from compressed-air distributors with threaded terminals M5.

The hose NW1 should only be used for short distances. The larger diameter of 3 mm guarantees good Operating Pressure.

The electrical connection is established by first soldering the wire to the Clip KL-300 and then fixing the Clip onto the end of the Pneumatic Probe. (Refer to marked positions in the drawings on the previous data sheets).

To avoid damage to the ends of the hose, only use a special cutter tool.

The various connections plates are controlled via micro-valves. Instead of a micro-valve a sealing plate (DP-1) can be used to seal the air outlet holes.

Item	tech. Designation	Order No.
Reducer piece	NW 3 / NW 1	RD-300-1
Reducer piece	NW 1 / NW 2	RD-300-1-2
Reducer piece	NW 3 / NW 2	RD-300-2
Threaded Terminal	M 5 / NW 1	VR-300-1
Threaded Terminal	M 5 / NW 2	VR-300-2
Threaded Terminal	M 5 / NW 3	VR-300-3
Threaded Terminal	M 3 / NW 1	VR-200-1
Threaded Terminal	M 3 / NW 2	VR-200-2
Threaded Terminal	M 3 / NW 3	VR-200-3
T-Piece (without Threaded Term.)	3 x M 5	PT-300-M5
T-Piece incl. 3 x VR-300-1	3 x NW 1	PT-300-1
T-Piece incl. 3 x VR-300-2	3 x NW 2	PT-300-2
Ten-fold Distributor	10 x M 5	PZ-010
Compressed-air Hose, Ø <sub>i</sub> 1,2; Ø <sub>o</sub> 2,0	NW 1	PS-300-1
Compressed-air Hose, Ø <sub>i</sub> 2,0; Ø <sub>o</sub> 3,9	NW 2	PS-300-2
Compressed-air Hose, Ø <sub>i</sub> 2,6; Ø <sub>o</sub> 4,0	NW 3	PS-300-3
Special Cutting Tool		SS-010
Dummy Plug for Distributor	B1/8	ST-PZ-010
Dummy Plug for Distributor	M 5	ST-PZ-M 5
Plug for Distributor	M 5-1/8a	ST-PZ-VR
Terminal for Hose NW 3	NM 5-PK 3	VR-PZ-3
Terminal for Hose NW 4	NM 5-PK 4	VR-PZ-4
3/2 Micro-Valve 12V (0,95 W)		MV 12
3/2 Micro-Valve 24V (0,95 W)		MV 24
Single-connection Plate	for 1 Valve	ASP-1
Multi-connection Plate	for 2-10 Valves	ASP-X
Sealing Plate	for conn. Plate	DP-1
Silencer	M3	28574
Silencer	M5	3981

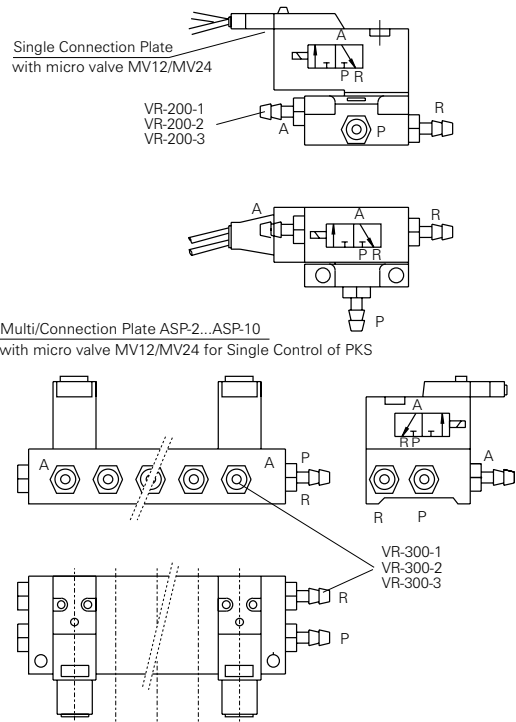

**Ordering Example:** To activate and control 5 pcs. Series PKS-300 simultaneously

5	PKS-300 xxx xxx x xx02 x	
x m	PS-300-1	Compressed-air Hose NW 1
1	PZ-010	Ten-fold Distributor
1	ST-PZ-010	Dummy Plug
1	VR-PZ-3	Terminal for Hose NW 3
5	VR-300-1	Terminal for Hose NW 1
x m	PS-300-3	Compressed-air Hose NW 3
1	MV 24	Micro-Valve 24V (incl. Stecker)
1	ASP-1	Single-connection Plate MV
2	VR-200-3	Terminal for Hose NW 3
5	ST-PZ-M5	Dummy Plug for Distributor





# The new RF-Probes Catalog

Optimal test solutions for your ambitious analog and digital RF-Applications.



*Besides general mechanical and electrical data, INGUN provides Scattering Parameter for several product types.*

**You can find a downloadable version of the RF-Probes catalog 2012/2013 on our website [www.ingun.com](http://www.ingun.com)**

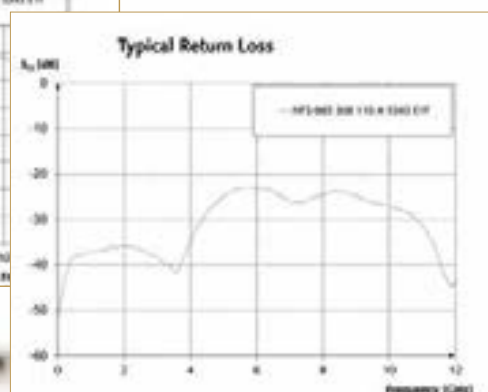
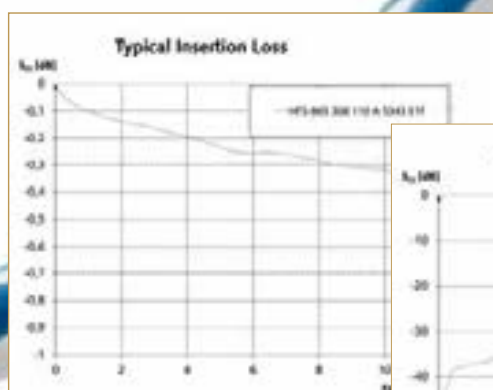

# Radio-frequency Test Probes/ Dipole Test Probes

Radio-frequency Test Probes are mainly used for measuring high-frequency signals (up to 6 GHz.). These Test Probes are designed co-axially, i.e. the measurement signals flow via the inner conductor and the outer conductor is used for the shielding of the signals. For the connection to the Test System the applicable co-axial cables are available.



### Application Examples:

- Sensitive measurement tasks with high measurement frequencies
- 4-pole measurements
- Contacting of common RF-Plugs and RF-Jacks
- Contacting of RF Test Points on PC-Boards
- Available in non-rotating version with a cut-out on the GND-Tip (i.e. for when the signal track on the PC-Board has been laid out accordingly)

### Advantages

- Very good measurement reliability
- Compact and stable design
- Modular design for flexible exchange of individual components (Note: in the series HFS-810 the inner and outer conductors are interchangeable)
- Large variety of different tip-styles for various RF-Plugs and RF-Jacks

# Radio-frequency Test Probes/ Dipole Test Probes

HFS <b>NEW</b>	
PC-Board Contacting (PCB)	98
HFS <b>NEW</b>	
Connector Contacting	99
HFS-010	100
HFS-110	101

# Radio-frequency Test Probes

Contacting of PC-Boards (PCB)

Frequency: up to 6 GHz  
Impedance: 50 Ω or 75 Ω

## Contacting of PC-Board Layouts with different test points

For a complete overview of all available testing solutions for contacting PC-Boards please see current RF-Catalog.



PCB-coax-closed



PCB-coax-open



PCB-coax-kidney-shaped

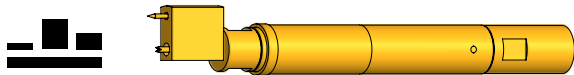

PCB Signal-Ground Structures

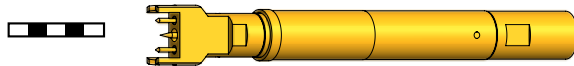

PCB Contacting from the side

## Customizing and connecting example

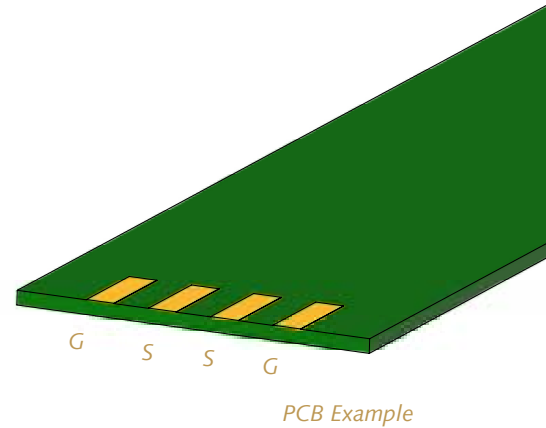
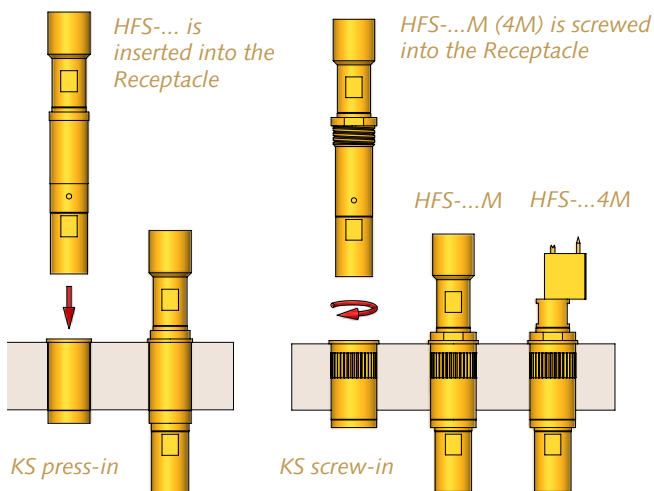

The HFS-...4M variants with asymmetric contacting tip have special securing crimps on the Probe. Subsequently, after the Probe has been screwed in completely, it can be rotated backwards into the right position within a range of 360°.

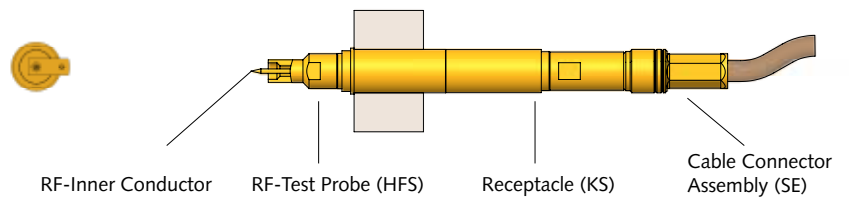

## Contacting of Connectors



## Customizing and connecting example

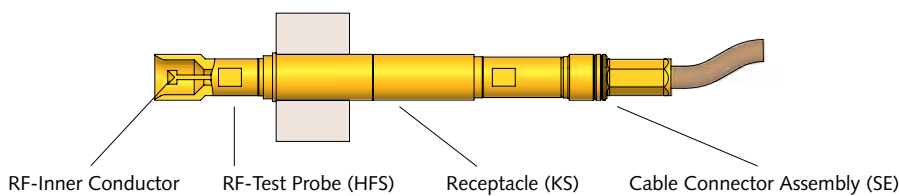

For a complete overview of all available testing solutions for contacting Connectors please see current RF-Catalog.

# HFS 010

Coaxial Dipole Probe/RF-Test Probe, 50 Ω, 200 MHz

## Grid:

≥ 2,54 mm

≥ 100 Mil

Installation Height: 9,5 mm (.374)

Recommended Stroke: 5,5 mm (.217)

## Mounting and Functional Dimensions

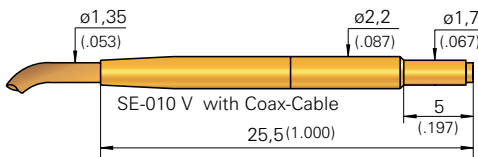
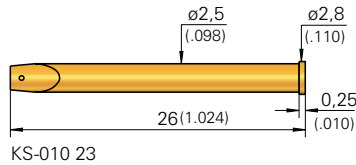
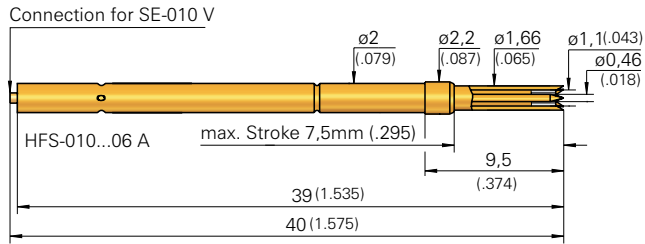

## Available Tip Styles

Inner Conductor

Material	Tip Style	Plating	Further Versions	
			∅	∅ (inch)
3 51		A		
3 54		A		

## Available Tip Styles

Outer Plunger

02	
06	

### Mechanical Data

<b>Working Stroke:</b>	5,5 mm (.217)
<b>Maximum Stroke:</b>	7,5 mm (.295)
<b>Spring Force at Working Stroke</b>	
- Outer Conductor:	1,2 N (4.3oz)
- Inner Conductor:	0,8 N (2.9oz)

### Materials

<b>Plunger:</b>	BeCu, gold-plated
<b>Barrel:</b>	Brass, gold-plated
<b>Spring:</b>	Steel, gold-plated
<b>Receptacle:</b>	Brass, gold-plated
<b>Insulation:</b>	Delrin

### Note:

The Receptacle KS-010 23 can be used from Grid 3,00 mm (120 Mil) up.

### Electrical Data

<b>Frequency Range:</b>	up to 200 MHz
<b>Current Rating:</b>	3 A
<b>R<sub>i</sub> typical:</b>	< 20 mΩ
<b>Impedance Test Probe:</b>	25 - 30 Ω
	200 MHz
<b>Impedance Cable:</b>	50 Ω/200 MHz
	90 pf/m

### Mounting Hole Size

<b>with Receptacle:</b>	∅ 2,48 - 2,49 mm (.0976 - .0980)
<b>without Receptacle:</b>	∅ 2,00 mm (.0787)

### Operating Temperature

<b>Standard:</b>	-40 up to +80 °C
------------------	------------------

### Note:

The Inner Conductor has a fixed connection with the Probe and therefore cannot be changed.

The spring-loaded Outer Plunger of the HFS-010 is also available with a shorter assembly-length on request.

## Ordering Example

Series	Tip Material	Tip Style	Tip Diameter (1/100 mm)	Plating	Spring Force (dN)	Outer Plunger (alternative 06)	Type
HFS	3 = BeCu	010	3 51	A = Gold	20	02	A
Test Probe:							
Plug with RF-Coaxial Cable pre-wired, Length 0,75 m (Special Length on request):							
Receptacle:							

Grid:  
 ≥ 4,50 mm  
 ≥ 177 Mil

Installation Height: 9,5 mm (.374)  
 Recommended Stroke: 4,0 mm (.157)

## Mounting and Functional Dimensions

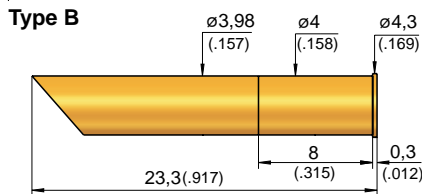
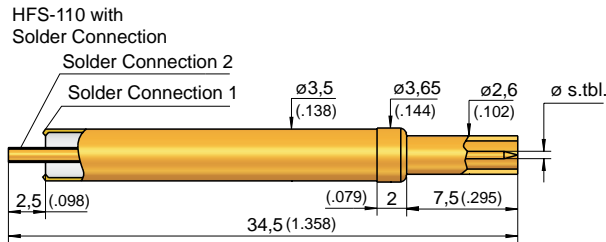
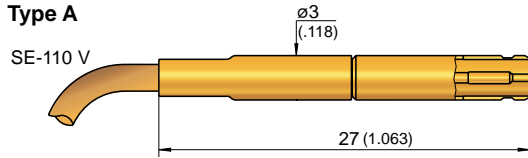
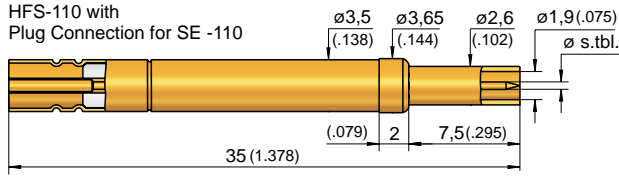

		Available Tip Styles Inner Conductor			
Material	Tip Style	Plating	Further Versions		
			∅	∅ (inch)	
3	01	A	∅ 0,50 (.020)		
3	02	A	∅ 0,50 (.020)		
3	03	A	∅ 1,15 (.045)		
3	04	A	∅ 1,15 (.045)		
3	05	A	∅ 1,15 (.045)		
3	06	A	∅ 1,15 (.045)		
3	07	A	∅ 1,00 (.039)		
3	08	A	∅ 1,15 (.045)		

		Available Tip Styles Outer Plunger	
02			
06			

### Mechanical Data

Working Stroke: 4,0 mm (.157)  
 Maximum Stroke: 5,0 mm (.197)  
 Spring Force at Working Stroke  
 - Outer Conductor: 3,0 N (10.8oz)  
 - Inner Conductor: 1,5 N (5.4oz)

### Materials

Plunger: BeCu, gold-plated  
 Barrel: Brass, gold-plated  
 Spring: Steel, gold-plated  
 Receptacle: Brass, gold-plated  
 Insulation: Teflon

### Electrical Data

Frequency Range: up to 700 MHz  
 Current Rating: 2 - 3 A  
 R<sub>i</sub> typical: < 20 mΩ  
 Impedance Test Probe: 50 Ω  
 Impedance SE-110 V with cable: 50 Ω

### Mounting Hole Size

with Receptacle: ∅ 3,98 - 3,99 mm (.1567 - .1571)  
 without Receptacle: ∅ 3,50 mm (.1378)

### Operating Temperature

Standard: -40 up to +80 °C

**Note:**  
 The Inner Conductor has a fixed connection with the Probe and therefore cannot be changed.

## Ordering Example

Series	Tip Material 3 = BeCu	Tip Style	Tip Diameter (1/100 mm)	Plating A = Gold	Spring Force (dN) Outer Conductor	Outer Plunger (alternative 06)	Type (alternativ B)	
HFS	110	3	04	115	A	30	02	A
SE-110V		Cable Type: RG 178 B/U						
KS-11023								

Test Probe:

Plug with RF-Coaxial Cable pre-wired,  
 Length 0,75 m (Special Length on request):

Receptacle:



## INGUN Radio-frequency Test Fixtures

The INGUN Radio-frequency Test Fixtures are developed and manufactured in accordance to customer demands. They allow testing of highly sensitive PC-Boards without electro-magnetic noise influences.

The UUT is completely shielded to the outside; both for the measurement as well as to protect the operator. Because the attenuation values determine the volume of the test chamber, then these must be known to enable design and manufacturing of the RF Fixture.

The signals, which must be measured on the PC-Board, are passed from the inside through the RF-cover to the outside via INGUN RF-Probes and then on to the Test System.

**More details about RF Test Fixtures can be found in our new Test Fixtures Catalog – or simply call us!**



*Radio-frequency Test Fixture  
based on MA 2111 with ATS  
2111/HF*

# High-current Test Probes

In the case of high-current Test Probes, the plunger is split in two sections. During the stroke movement, the two plunger sections are deflected away from each other in the radial direction. This leads to the enlargement of the contact zones, i.e. the signal transfer areas. This then allows higher currents to be applied.

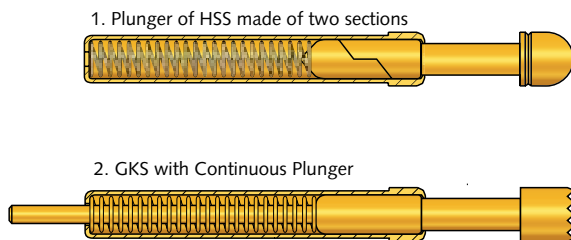

Alternatively to this standard high-current Test Probe design, such Test Probes with a continuous plunger (i.e. with a tail-end on the plunger) can also be used. Due to the direct signal flow, this design provides a very constant and stable low resistance. However, when using such a design, it must be taken into consideration that the cable (which is connected to the tail-end of the plunger) is constantly under stress due to the movement. This handicap is also apparent when using highly flexible, braided cable.

# High-current Test Probes

HSS-118	104
HSS-120	105
HSS-520/520 M	106
HSS-150	107
HSS-2259	108
HSS-2513	108
HSS-2516	108
HSS-2526	108
HSS-2532	108

Screw-in HSS from page 143 on

# HSS 118

High Current Probe up to 16 A

## Grid:

≥ 2,54 mm

≥ 100 Mil

Installation Height: 10,3 resp. 18,3 mm (.406/ .720)

Recommended Stroke: 4,0 mm (.157)

## Mounting and Functional Dimensions

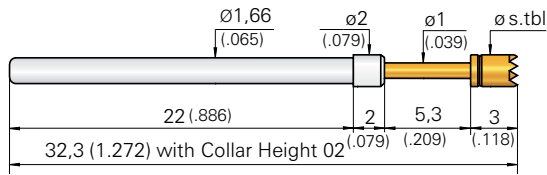

### Collar Height and Installation Height

The Installation Height of the Tip (Dimension without Receptacle) is determined by the Collar Height.

Collar Height	Installation Height
02	10,3 mm (.406)
03	11,3 mm (.445)
04	12,3 mm (.484)
05	13,3 mm (.524)
06	14,3 mm (.563)
07	15,3 mm (.602)
08	16,3 mm (.642)
09	17,3 mm (.681)
10	18,3 mm (.720)

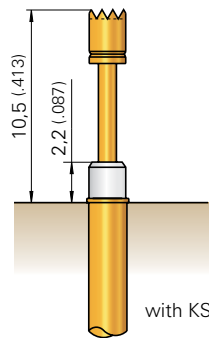

with KS

### Mechanical Data

For Tip Styles with Diameter ≥ 1 mm (.039)

Working Stroke: 4,0 mm (.157)

Maximum Stroke: 5,3 mm (.209)

For Tip Styles with Diameter ≤ 1 mm (.039)

Maximum Stroke: 8,0 mm (.315)

Spring Force at Work. Stroke: 1,5 N (5.4oz)

alternative: 0,8 N (2.9oz)\*\*\*;

2,25 N (8.1oz)

### Electrical Data

Current Rating: max. 16 A

with Spring Force ≥ 1,5 N + Plunger of BeCu

\*\*\* Spring force < 1.5 N are not recommended for high-current applications

R<sub>i</sub> typical: < 10 mΩ

### Materials

Plunger: BeCu or Steel, gold-plated

Barrel: Brass, silver-plated

Spring: Steel, gold-plated or Stainless Steel

Receptacle: Brass, gold-plated

### Mounting Hole Size

HSS-118 and KS-112 xx

with Receptacle: see KS-112, Page 50

without Receptacle: ø 1,65 mm (.0650)

### Operating Temperature

Standard: -100° up to +200° C

## Available Tip Styles

Material	Tip Style	Plating	Further Versions	
			ø	ø (inch)
3 02		A	ø 1,00 (.039)	
3 03		A	ø 2,00 (.079)	
3 05		A	ø 0,80 (.031)	0,65 (.026)
3 05		A	ø 1,00 (.039)	
3 05*		S	ø 2,00 (.079)	
3 06		A	ø 2,00 (.079)	1,30 (.051) 1,60 (.063) 1,80 (.071) 2,50 (.098) 3,50 (.138)
2 14		A	ø 1,30 (.051)	
3 17		A	ø 1,75 (.069)	2,00 (.079)
3 19		A	ø 2,00 (.079)	
3 53**		S	ø 2,00 (.079)	

\* pressed-in Silver stud

\*\* pressed-in Silver stud, Tip Length 3,5 mm (.138)

Installation Height plus 0,5 mm (.020)

### Applications:

- High-current transfer during Functional Test
- Power-Supply-Test
- Burn-in-Test
- Contacting element in permanent use
- Usage with AC and DC

### Note:

HSS-118 are used with Receptacles of the Series KS-112 (see Page 50).

Insertion and Extraction Tools for HSS and KS see Page 118.

### Note:

Screw-in Version see HSS-118 ... M on Page 144.

## Ordering Example

Series	Tip Material 2 = Steel 3 = BeCu	Tip Style	Tip Diameter (1/100 mm)	Plating A = Gold S = Silver	Spring Force (dN)	Collar Height (mm)
--------	---------------------------------------	-----------	----------------------------	-----------------------------------	----------------------	-----------------------

Test Probe:

H S S 1 1 8 3 1 7 1 7 5 A 1 5 0 2

Receptacles for HSS-118:

K S - 1 1 2 3 0      K S - 1 1 2 4 7

**Grid:**  
 ≥ 4,00 mm  
 ≥ 160 Mil

**Installation Height:** 10,3/13,3/18,3 mm (.406 - .720)  
**Recommended Stroke:** 4,0 mm (.157)

### Mounting and Functional Dimensions

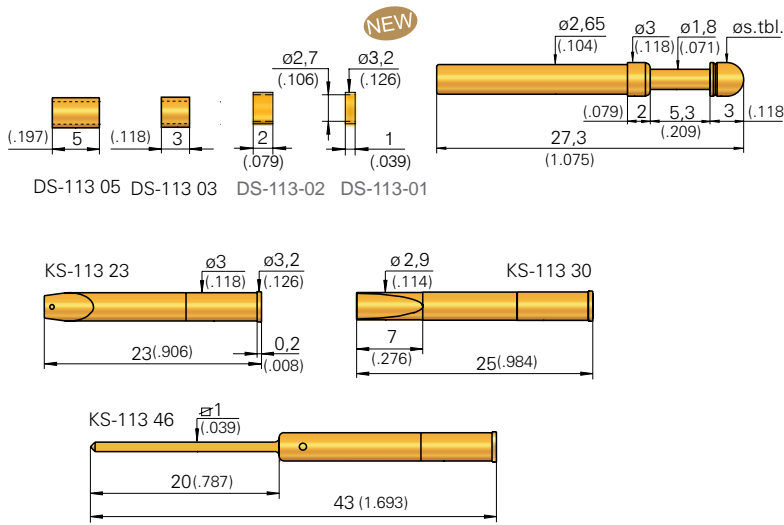

#### Collar Height and Installation Height

The Installation Height of the Tip (Dimension without Receptacle) is determined by the Collar Height.

Collar Height	Installation Height (without Receptacles)
02	10,3 mm (.406)
05	13,3 mm (.524)
10	18,3 mm (.720)

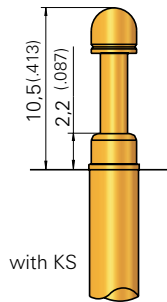

#### Mechanical Data

**Working Stroke:** 4,0 mm (.157)  
**Maximum Stroke:** 5,3 mm (.209)  
**Spring Force at Work. Stroke:** 1,5 N (5.4oz)  
**alternative:** 1,0 N (3.6oz)\*\*\*; 2,25 N (8.1oz); 3,0 N (10.8oz)

#### Electrical Data

**Current Rating:** max. 24 A  
 with Spring Force ≥ 1,5 N + Plunger of BeCu  
 \*\*\*\* Spring force < 1.5 N are not recommended for high-current applications  
**R<sub>i</sub> typical:** < 10 mΩ

#### Operating Temperature

**Standard:** -100° up to +200° C

#### Materials

**Plunger:** BeCu or Steel, gold-plated  
**Barrel:** Brass, gold-plated  
**Spring:** Steel, gold-plated or Stainless Steel  
**Receptacle:** Brass, gold-plated

#### Mounting Hole Size

**HSS-120 and KS-113:**  
**with Receptacle:** ∅ 2,98 - 2,99 mm (.1173 - .1177)  
**without Receptacle:** ∅ 2,65 mm (.1043)

### Available Tip Styles

Material	Tip Style	Plating	Further Versions	
			∅	∅ (inch)
3 02		A	4,00	(.157)
3 03		A		
3 05		A		
3 05		A	3,00	(.118)
3 05**		S		
3 06		A	3,00 4,00	(.118) (.157)
3 17		A		
3 19		A		
2 51*		A		
3 53***		S		
3 55*		A		

\* Tip Length 5 mm (.197) - Installation Height with Collar Height 02: 12,5 mm (.492)  
 \*\* pressed-in Silver stud  
 \*\*\* pressed-in Silver stud, Tip Length 3,5 mm (.138) Installation Height plus 0,5 mm (.020)

#### Applications:

- High-current transfer during Functional Test
- Power-Supply-Test
- Burn-in-Test
- Contacting element in permanent use
- Usage with AC and DC

#### Tools:

Insertion and Extraction Tools for HSS see Page 118.

#### Note:

Screw-in Version see HSS-120 ... M on Page 145.

### Ordering Example

Series	Tip Material	Tip Style	Tip Diameter (1/100 mm)	Plating	Spring Force (dN)	Collar Height (mm)
	2 = Steel 3 = BeCu			A = Gold S = Silver		
Test Probe:	HSS	120	306	300	A	1502
Receptacles for HSS-120:	KS-11330	KS-11323	KS-11346			

# HSS 520 / 520 M

Short-Stroke High-Current Probe up to 24 A

**Grid:**

≥ 4,0 mm

≥ 160 Mil

**Installation Height:** 7,2 mm (.283)

**Recommended Stroke:** 2,8 mm (.110)

## Mounting and Functional Dimensions

### HSS-520

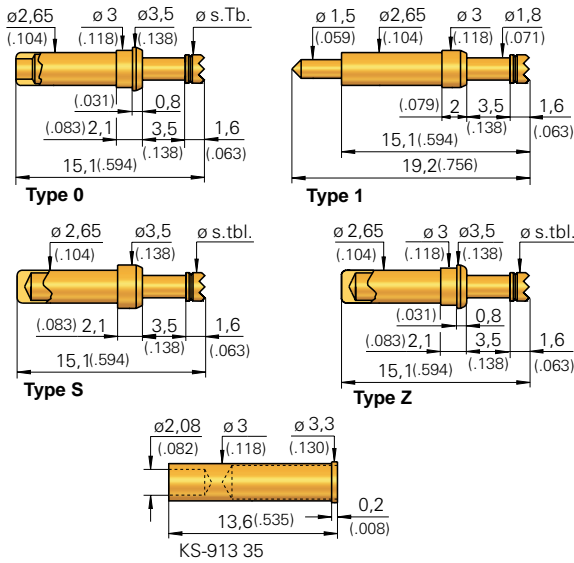

## Available Tip Styles

Material	Tip Style	Plating	Further Versions	
			∅	∅ (inch)
3 06		A	∅ 2,30 (.091)	
3 06		A	∅ 3,50 (.138)	

### HSS-520 ... M

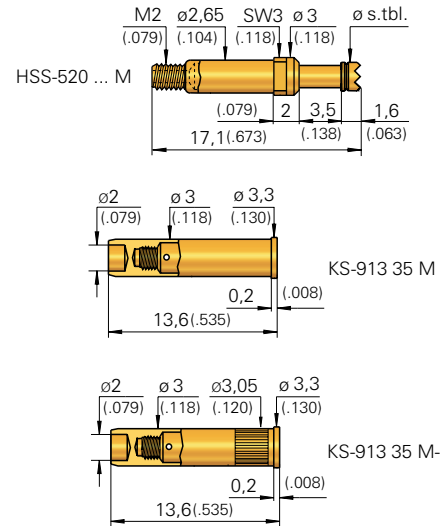

### Mechanical Data

**Working Stroke:** 2,8 mm (.110)  
**Maximum Hub:** 3,5 mm (.138)  
**Spring Force at Work. Stroke:** 1,5 N (5.4oz)

### Materials

**Plunger:** BeCu, gold-plated  
**Barrel:** Brass, gold-plated  
**Spring:** Stainless Steel  
**Receptacle:** Brass, gold-plated

### Electrical Data

**Current Rating:** 24 A  
**R<sub>i</sub> typical:** < 20 mΩ

### Mounting Hole Size

**in Material CEM 1 and FR 4:**  
**for KS-913 35:** ∅ 2,98 - 2,99 mm (.1173 - .1177)  
**for KS-913 35 M-R:** ∅ 3,00 - 3,02 mm (.1181 - .1189)  
**without Receptacle:** ∅ 2,65 mm (.1043)

### Collar Height and Installation Height

The Installation Height of the Tip is determined by the Collar Height.

Collar Height	Installation Height
02	7,2 mm (.283)

**Note:**

- Typ Version
- 0 End of Probe Barrel open; with reduced collar ∅ 3 mm
- 1 End of Probe Barrel with solder terminal
- M End of Probe Barrel with thread M2 for KS-913 35 M (-R)
- S End of Probe Barrel closed; can be soldered into PCB
- Z End of Probe Barrel closed; can be soldered into PCB; with reduced collar ∅ 3 mm

Warning: Soldering the Probes demands great care. High temperatures must not reach the inside of the barrel, because this could destroy the spring.

The Receptacle KS-913 35 can only be combined with the Probe Types 0, S and Z. The Receptacle KS-913 35 M can only be combined with the Probe Type M.

**Tools:**

Insertion and Extraction Tools for GKS and KS see Page 118.

**Note:**

HSS-520 ... M will be screwed into Receptacle KS-913 35 M (-R), using special tools (see Page 170/171).

Recommended Screw-in Torque:  
 Min.: 5 Ncm / Max.: 10 Ncm

## Ordering Example

Series	Tip Material	Tip Style	Tip Diameter (1/100 mm)	Plating	Spring Force (dN)	Collar Height (mm)	Type
	3 = BeCu			A = Gold R = Rhodium			1, 0, S, M, Z

Test Probe:

H S S 5 2 0 3 0 6 2 3 0 A 1 5 0 2 M

Receptacles:

K S - 9 1 3 3 5 K S - 9 1 3 3 5 M K S - 9 1 3 3 5 M - R

**Grid:**  
 ≥ 5,08 mm  
 ≥ 200 Mil

**Installation Height:** 10,8 / 13,8 mm (.425/ .543)  
**Recommended Stroke:** 4,4 / 7,4 mm (.173/ .291)

### Mounting and Functional Dimensions

#### HSS-150

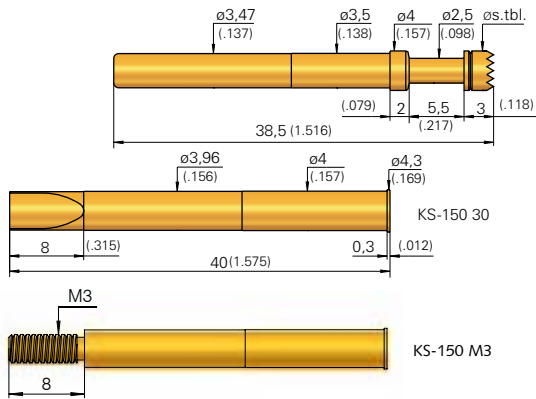

#### HSS-150 ... H

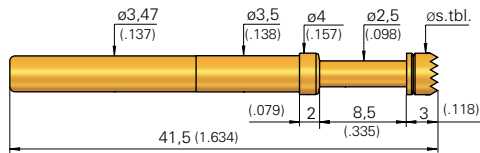

#### Collar Height and Installation Height

The Installation Height of the Tip is determined by the Collar Height.

Collar Height	Installation Height (with Receptacles)
02	10,8 mm (.425)
02 H	13,8 mm (.543)

#### Mechanical Data

**Working Stroke:** 4,4 mm (.173)  
 Typ "H": 7,4 mm (.291)  
**Maximum Stroke:** 5,5 mm (.217)  
 Typ "H": 8,5 mm (.335)  
**Spring Force at Work. Stroke:** 3,0 N (10.8oz)  
**alternative:** 5,0 N (18.1oz);  
 10 N (36 oz; „99“ in ordering number)

#### Electrical Data

**Current Rating (at room temperature):** 50 A  
 (for short loads up to 80 A)  
**R<sub>i</sub> typisch:** ≤ 10 mΩ

#### Operating Temperature

**Standard:** -100° up to +200° C

#### Materials

**Plunger:** BeCu, gold-plated or Silver stud  
**Barrel:** Brass, gold-plated  
**Spring:** Stainless Steel  
**Receptacle:** Brass, gold-plated

#### Mounting Hole Size

**HSS-150 and KS-150:**  
**with Receptacle:** ∅ 3,98 - 3,99 mm  
 (.1567 - .1571)  
**without Receptacle:** ∅ 3,50 mm (.1378)

#### Note:

Screw-in Version see HSS-150 ... M on Page 146.

### Available Tip Styles

Material	Tip Style	Plating	Further Versions	
			∅	∅ (inch)
3	02	A		
3	03	A		
3	05*	S		
3	06	A	3,00	(.118)
3	17	A		
3	19	A		

\* pressed-in Silver stud

### Available Tip Styles

Special Version HSS-150 ... H

Material	Tip Style	Plating	Further Versions	
			∅	∅ (inch)
3	02	A		
3	05*	S		
3	06	A		
3	17	A		

Total Length 41,5 mm (1.634), Special Designation "H"

\* pressed-in Silver stud

#### Applications:

- High-current transfer during Functional Test
- Power-Supply-Test
- Burn-in-Test
- Contacting element in permanent use
- Usage with AC and DC

#### \* Tip Style 05 S

The pressed-in silver stud prevents burning or welding of the test probe to the test point.

### Ordering Example

Series	Tip Material 3 = BeCu	Tip Style	Tip Diameter (1/100 mm)	Plating A = Gold S = Silver	Spring Force (dN)	Collar Height (mm)	Special Designation (alternative "H")
Test Probe:	HSS	150	305	400	S	30	02
Test Probe:	HSS	150	306	400	A	30	02H
Receptacles for HSS-150:	KS-150	30	KS-150	M3			



# HSS 2259-2532

High-Current Probe from 25 A up to 400 A

Installation Heights: see below  
Recommended Stroke: 7,0 mm (.276)

## High Current Test Probe

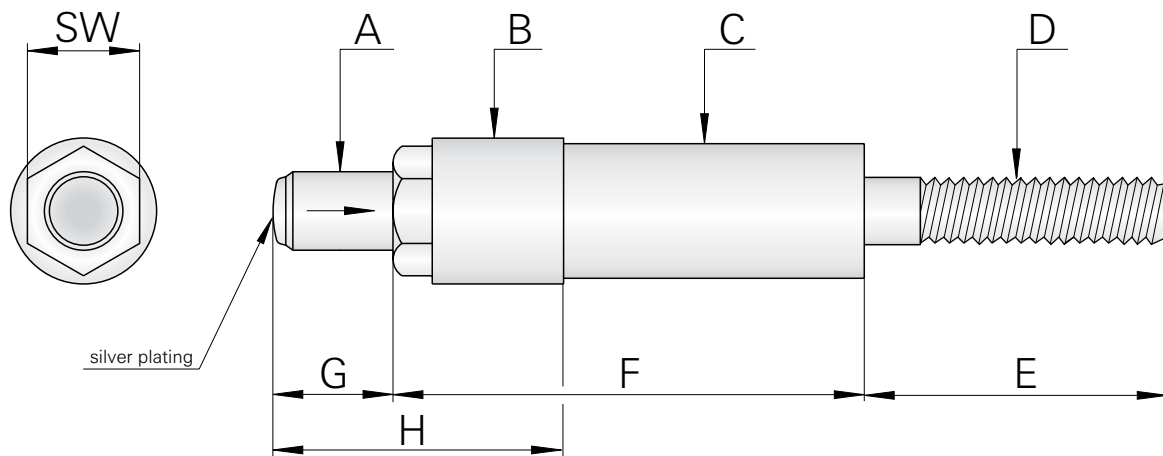

Order-No.	Maxim. Current (A)	Transition Resistance (mΩ)	Spring Force Pre-Load N (oz)	Spring Force Work. Stroke N (oz)	Ø A mm (inch)	Ø B mm (inch)	Ø C mm (inch)	D (Thread)	E mm (inch)	F mm (inch)	G mm (inch)	H mm (inch)	SW Spanner Size	Silver Plating mm (inch)
2259	25	1,0	5 (18.1)	10 (36.0)	4,9 (.193)	9 (.354)	9 (.354)	M5	20 (.787)	28 (1.102)	9,5 (.374)	37,5 (1.476)	SW 7 (.276)	Ø 4 (.157)
2513	35	0,7	6 (21.7)	12 (43.2)	7 (.276)	13 (.512)	12 (.472)	M6	27 (1.063)	42 (1.654)	10,5 (.413)	25,7 (1.012)	SW 10 (.394)	Ø 6 (.236)
2516	100	0,5	7 (25.2)	17 (61.2)	9 (.354)	16 (.630)	15 (.591)	M6	27 (1.063)	42,2 (1.661)	12 (.472)	27 (1.063)	SW 12 (.472)	Ø 6 (.236)
2526	200	0,3	38 (136.8)	58 (208.8)	16 (.630)	26 (1.024)	25 (.984)	M8	27 (1.063)	52 (2.047)	11 (.433)	40 (1.575)	SW 20 (.787)	3 x Ø 6 3 x (.236)
2532	400	0,1	70 (252.0)	116 (417.6)	25,9 (1.020)	32 (1.260)	32 (1.260)	M14	51 (2.01)	52 (2.047)	11 (.433)	63 (2.480)	-	3 x Ø 8 3 x (.315)

### Mechanical Data

**Working Stroke:** 7,0 mm (.276)  
**Maximum Stroke:** see Table above - column "G"

### Electrical Data

see Table above

### Operating Temperature

+1° up to +80° C

### Materials

**Plunger:** Brass, silver-plated  
Silver-plating on the Contact Surface  
**Barrel:** Brass, silver-plated  
**Spring:** Stainless Steel

## Contacting Terminal for High Current Test Probes (with silver plating)

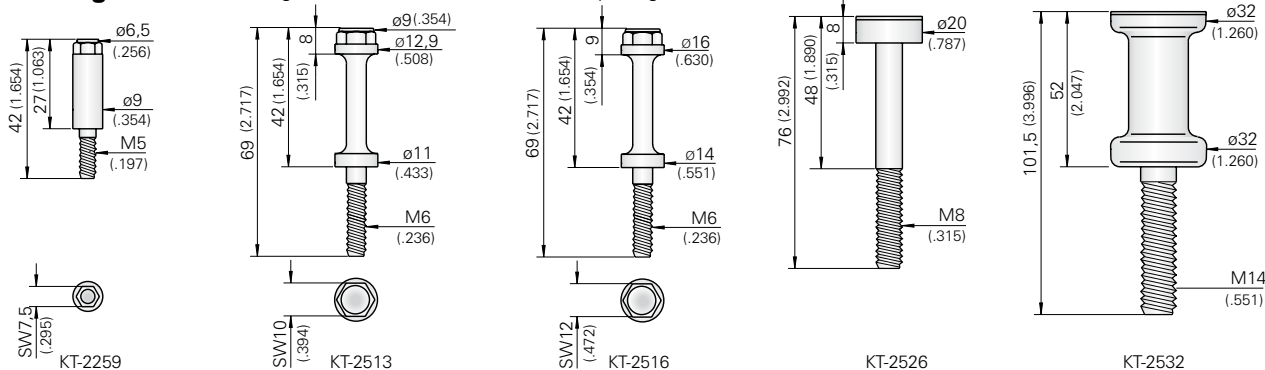

## Ordering Example

Test Probe:

H S S 2 2 5 9

Contact Terminal:

K T 2 2 5 9

### Materials

**Contact Terminals:** Brass, silver-plated  
Silver-plating on the Contact Surface

# Fixture Customizing

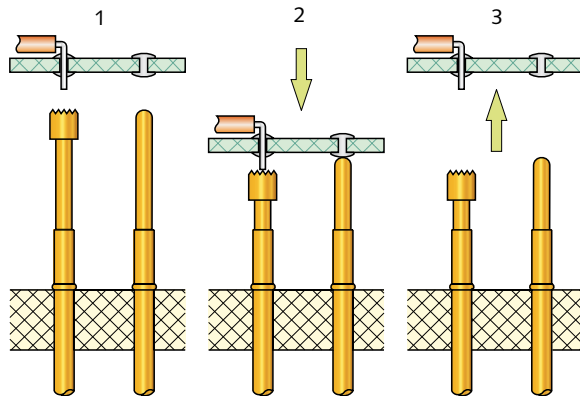

## Stroke-measuring Probe (HMS)

To check the stroke of a Test Fixture this type of Test Probe can be used. These Test Probes are assembled in such a way that the plunger can be pushed down but will not come out again on its own. Subsequently the stroke of the Test Fixture after activation can be measured.

### Instructions for use:

1. Insert HMS instead of a standard Test Probe
2. Activate the Test Fixture. Subsequently, the plunger of the HMS is pressed down. Crimps on the barrel secure the plunger in the activated position.
3. After de-activation of the Test Fixture the working stroke of the HMS can be measured.

After measuring, the plunger can be pulled out again using only little force. Such a Stroke-measuring Probe can be used many times.

# Interfaces / Customizing

GKS-945	110
GKS-946	110
GKS-938	110
GKS-100	110
GKS-100 357 ...	110
GKS-100 307 150 ...	110
GKS-100 306 229 ...	110
Contact Terminal KT	111
GKS-925 TJA	112
HMS ff.	112
HMS-075	112
HMS-100	112
HMS-422	112
GKS-416	113
GKS-102	113
GKS-504	113
GKS-414	113
Test Fixtures accessories <span style="border: 1px solid black; border-radius: 50%; padding: 2px;">NEW</span>	114–116

# Interface Probes

for GenRad/Pylon Augat, R & S, Teradyne, Factron and Agilent/HP 3070 Test Systems

## Mounting and Functional Dimensions

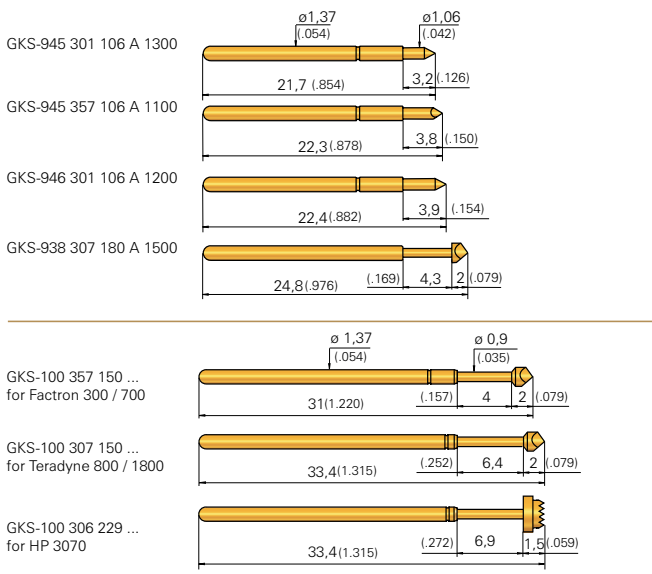

### Receptacles

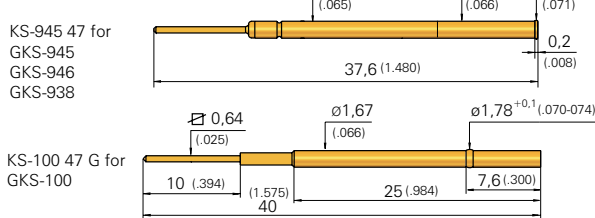

### Mechanical Data

Type	Work. Stroke mm (inches)	Max. Stroke mm (inches)	Spring Force at Work. Stroke N (oz)	Installation Height mm (inches)
945 301	2,1 (.083)	3,2 (.126)	1,3 N (4.7oz)	3,7 (.146) *
945 357	2,6 (.102)	3,2 (.126)	1,1 N (4.0oz)	4,3 (.169) *
946 301	3,2 (.126)	3,9 (.154)	1,2 N (4.3oz)	4,4 (.173) *
938 307	3,6 (.142)	4,3 (.169)	1,5 N (5.4oz)	6,8 (.268) *
100 357	3,0 (.118)	4,0 (.157)	1,2 (Ord.-No.=10)	13,6 (.535) / variable **
100 ...	4,3 (.169)	6,35 (.250)	1,0/2,0/2,25/3,0	16,0 (.630) / variable **

\*with KS-945 47    \*\* with KS-100 47 G

### Mounting Hole Size \*\*\*

for KS-945 47:  
- in CEM 1 using collar  $\varnothing 1,68 - 1,69$  mm (.0661 - .0665)

for KS-100 47 G:  
- Press-ring inserted  $\varnothing 1,70 - 1,75$  mm (.0669 - .0689)

### Electrical Data

Current Rating: 4 - 5 A  
R<sub>i</sub> typical: 20 mΩ

### Materials

Plunger: BeCu, gold-plated  
Barrel: Nickel-Silver or Bronze, gold-plated  
Spring: Steel, gold-plated

### Collar Height and Installation Height

The Installation Height is variable, depending on position of the Press-ring is set.

## Ordering Example

Series	Tip Material	Tip Style	Tip Diameter (1/100 mm)	Plating	Spring Force (dN)	Collar Height (mm)	Special Designation (see Note)
Test Probe:	3 = BeCu			A = Gold			
Receptacle for GKS 945 / 946 / 938:							
Receptacle for GKS-100:							

GKS-945 / 946 for GenRad/Pylon Augat/R&S-Interfaces				
Material	Tip Style	Plating	Further Versions	
			$\varnothing$	$\varnothing$ (inch)
3 01		A	$\varnothing 1,06$ (.042)	
3 57		A	$\varnothing 1,06$ (.042)	

GKS-938				
Material	Tip Style	Plating	Further Versions	
			$\varnothing$	$\varnothing$ (inch)
3 07		A	$\varnothing 1,80$ (.071)	

GKS-100 for Factron 300/700 Interface				
Material	Tip Style	Plating	Further Versions	
			$\varnothing$	$\varnothing$ (inch)
3 57		A	$\varnothing 1,50$ (.059)	

GKS-100 for Teradyne 800/1800 Interface				
Material	Tip Style	Plating	Further Versions	
			$\varnothing$	$\varnothing$ (inch)
3 07		A	$\varnothing 1,50$ (.059)	

GKS-100 for Agilent/HP 3070 Interface				
Material	Tip Style	Plating	Further Versions	
			$\varnothing$	$\varnothing$ (inch)
3 06		A	$\varnothing 2,29$ (.090)	

### \*\*\* Services:

Customized Contact Blocks drilled according to customer demands (and matching certain INGUN Receptacles) are available from INGUN.

### Note:

To order Test Probes with bent barrel end, use Special Designation „B“ (Banana).  
Contacting Terminals for various Interfaces on request.

**Grid:**  
 ≥ 2,54 mm  
 ≥ 100 Mil

# Contact Terminals

for Interfaces and Transfer Fields

e-type®  
Probes

ICT / FCT

Bead Probes

Fine Pitch

Metric Stand.

Solderable

Short-stroke

Flying Probes

DKS

SKS

PKS / PSK

RF / Dipole Test Probes

HSS

Fixture customizing

Tools

Cable Test Probes

## Contact Terminals with Collar Height: 3 mm (.118)

### KT-254 W-E03 (wire-wrap)

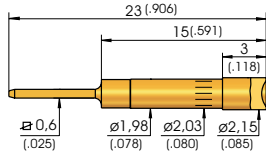

### KT-254 W3 E03 (wire-wrap)

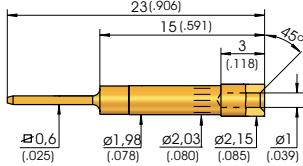

### KT-254 L-E03 (Solder)

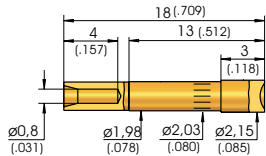

### KT-254 L3 E03 (Solder)

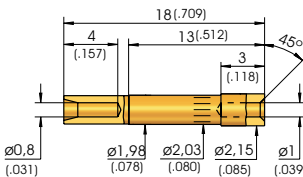

### KT-120 L3 E02 - 30 (Solder) High-current Contact Terminal

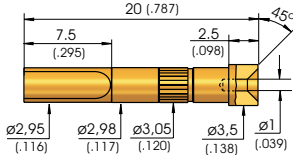

### KT-150 L3 E03 - M3 High-current Contact Terminal

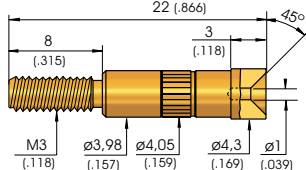

## Contact Terminals with Collar Height: 2 mm (.079)

### KT-254 W-E02 (wire-wrap)

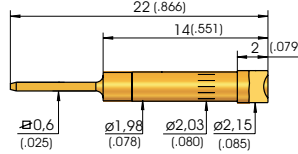

### KT-254 W3 E02 (wire-wrap)

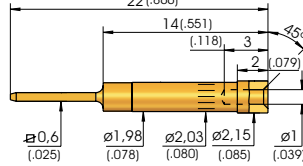

### KT-254 L-E02 (Solder)

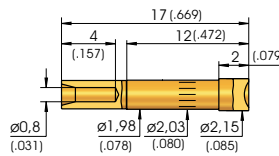

### KT-254 L3 E02 (Solder)

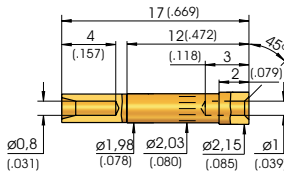

### KT-254 L3 E02 - 30 (Solder Connection)

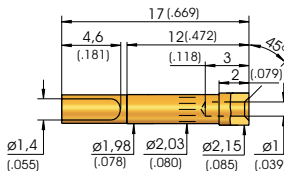

### KT-254 W-PL (wire-wrap)

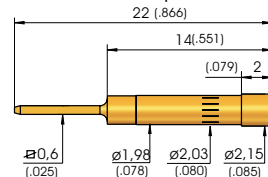

## Other Contact Terminals:

### KT-254 W3 E12 (wire-wrap)

For assembly in INGUN-ZSK Transfer Field (ZSK = Top-side Contacting Unit)

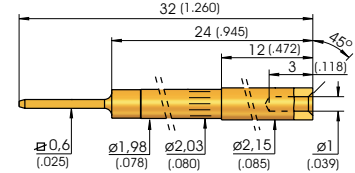

### KT-158 02 (Order No. 9408) Contacting Terminal for GenRad Interface

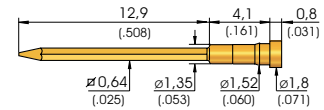

### KT-158 (Order No. 3650)

Contacting Terminal for Zehntel Interface

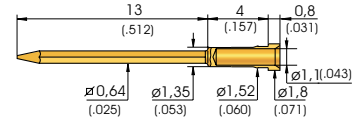

### KT-158 06 (Order No. 21814)

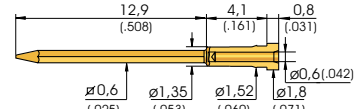

### KT-586 102 400 R

Contacting Terminals for general usage

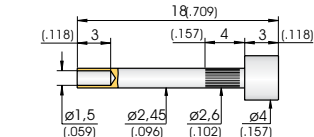

### KT-279 102 300 (to solder in)

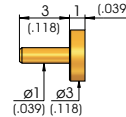

### KT-112 143 215 E02 (Replaceable) Will be used with KS-112, see Page 50)

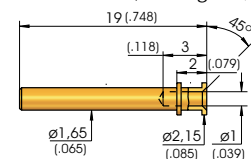

## Mounting Hole Size \*

### for KT-254:

in CEM1 ø 1,98 - 2,00 mm (.0780-.0787)

in FR4 ø 1,98 - 1,99 mm (.0780-.0783)

### for KT-158:

in CEM1 and FR4 ø 1,40 mm (.0551)

### for KT-586:

in CEM1 and FR4 ø 2,55 - 2,57 mm (.1004-.1012)

### for KT-120:

in CEM1 and FR4 ø 3,00 - 3,02 mm (.1181 - .1189)

### for KT-150:

in CEM1 and FR4 ø 4,00 - 4,02 mm (.1575 - .1583)

### \* Services:

Customized Contact Blocks drilled according to customer demands (and matching certain INGUN Receptacles) are available from INGUN.

## Electrical Data

R<sub>i</sub> typical: < 5 mΩ

## Materials

Contact Terminals: Brass, gold-plated  
 KT-586: Brass, rhodium-plated

## Collar Height and Install. Height for KT-254

The Installation Height of the Contact Terminals is determined by the collar Height.

# Test Probes for Fixture Customizing

## Mounting and Functional Dimensions

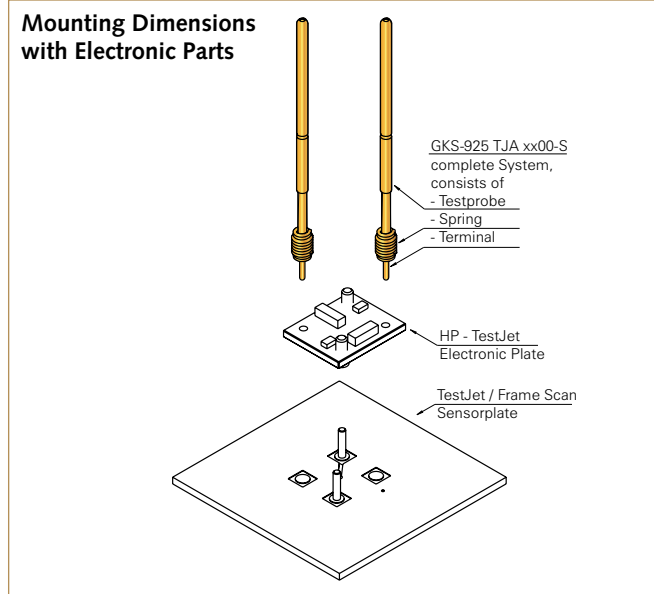
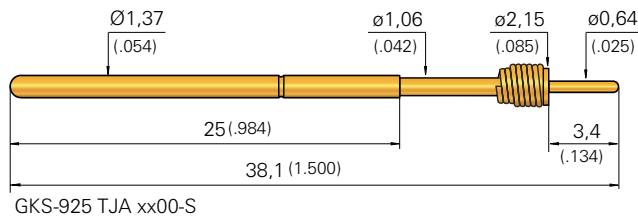

### GKS/925 TJA

Test Probes for the assembly of HP TestJet or Teradyne FrameScan applications. The spring-loaded tip balances out possible slanting of the Sensor Plate on the device (IC, connector etc.)  
 Receptacles see GKS-100 (Page 29).

### Mechanical Data

**Working Stroke:** 5.0 mm (.197)  
**Spring Force at Work. Stroke:** 1,0 N (3.6oz)  
**alternative:** 1,5 N (5.4oz); 2,0 N (7.2oz); 3,0 N (10.8oz)

### Materials

**Plunger:** BeCu, gold-plated  
**Barrel:** Bronze, gold-plated  
**Spring in GKS:** Steel, gold-plated  
**Outer Spring:** BeCu, gold-plated  
**Contact Terminal:** Brass, gold-plated

### Electrical Data

**Current Rating:** 3 - 5 A  
**R<sub>i</sub> typical:** < 20 mΩ

### Ordering Example

Test Probe: **G K S 9 2 5 T J A 1 0 0 0 - S**

## Stroke Measurement Probe

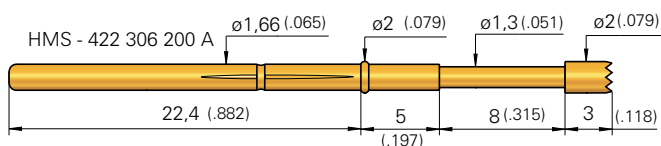
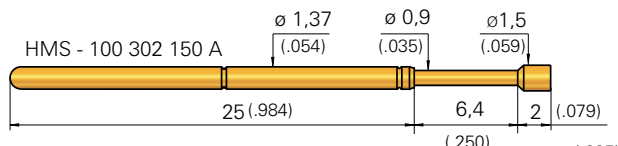
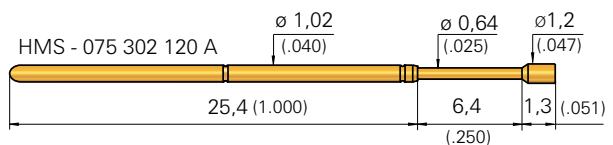

### Description Measurement Probe

Test Probe for checking the stroke of a Test Fixture. Procedure:

1. Install HMS instead of standard Probe
2. Activate Test Fixture. With this, the Plunger of the HMS is pressed down. Crimps on the barrel of the Probe hold the plunger down in the activated position.
3. After de-activating the Test Fixture, the stroke can now be measured on the pressed down plunger.

Note: the plunger can be easily pulled out again and the Probe re-used many times.

### Application Area

Tip Style „05“:

- For contacting Test Pads

Tip Styles „02 / 06“:

- For contacting Component Pins

Further Versions or Series on request.

### Ordering Example

HMS-075:	H	M	S	0	7	5	3	0	5	0	6	4	A
HMS-100:	H	M	S	1	0	0	3	0	2	1	5	0	A
HMS-422:	H	M	S	4	2	2	3	0	6	2	0	0	A

# Test Probes for Fixture Customizing

## PCB Support Probe GKS-416

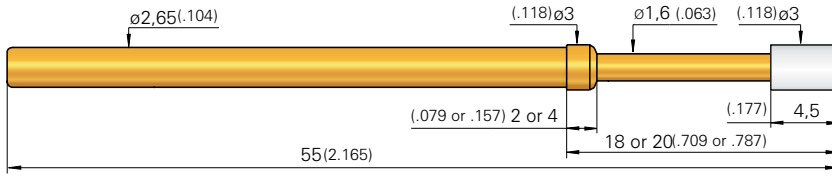

### Ordering Example

GKS for Install. Height 18,0 mm (.709):

G	K	S	4	1	6	0	0	2	3	0	0	A	5	0	0	2
---	---	---	---	---	---	---	---	---	---	---	---	---	---	---	---	---

GKS for Install. Height 20,0 mm (.787):

G	K	S	4	1	6	0	0	2	3	0	0	A	5	0	0	4
---	---	---	---	---	---	---	---	---	---	---	---	---	---	---	---	---

### Mechanical Data

**Working Stroke:** 9,2 mm (.362)  
**Maximum Stroke:** 11,5 mm (.453)  
**Spring Force at Work.Stroke:** 5,0 N (18.1oz)

### Materials

**Plunger:** BeCu , gold-plated  
**Barrel:** Brass, gold-plated  
**Spring:** Steel, gold-plated  
**Tip:** Delrin  
**Receptacle:** KS-113 23

### Mounting Hole Size

see GKS-113 (Page 58)

## PCB Support Probe GKS-102

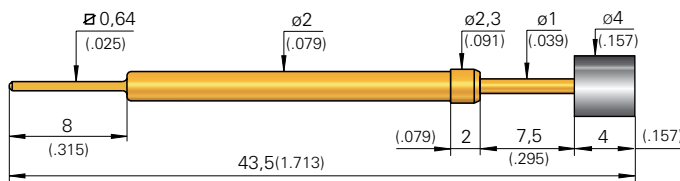

### Ordering Example

GKS for Install. Height 13,5 mm (.531):

G	K	S	1	0	2	2	5	0	4	0	0	P	3	0	0	2	W
---	---	---	---	---	---	---	---	---	---	---	---	---	---	---	---	---	---

### Mechanical Data

**Working Stroke:** 4,8 mm (.189)  
**Maximum Stroke:** 6,5 mm (.256)  
**Spring Force at Work. Stroke:** 1,5 N (5.4oz)  
**alternative:** 3,0 N (10.8oz); 5,0 N (18.1oz)

### Materials

**Plunger:** Steel , gold-plated  
**Barrel:** Brass, gold-plated  
**Spring:** Steel, gold-plated  
**Tip:** PVC  
**Receptacle:** KS-102 23  
**Mounting Hole Size:** see GKS-102, Page 56

## Test Probe GKS-504

with continuous Plunger - for the activation of a Micro Switch

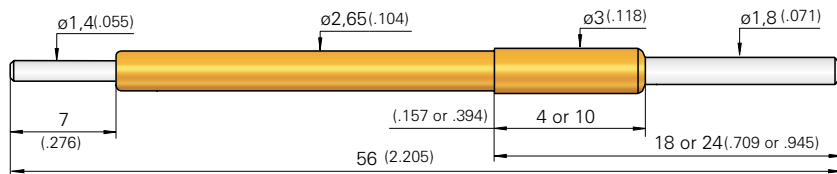

### Ordering Example

GKS for Install. Height 18,0 mm (.709):

G	K	S	5	0	4	3	0	5	1	8	0	N	0	5	0	4
---	---	---	---	---	---	---	---	---	---	---	---	---	---	---	---	---

GKS for Install. Height 24,0 mm (.945):

G	K	S	5	0	4	3	0	5	1	8	0	N	5	0	1	0
---	---	---	---	---	---	---	---	---	---	---	---	---	---	---	---	---

### Mechanical Data

**Working Stroke:** 11,2 mm (.441)  
**Maximum Stroke:** 14 mm (.551)  
**Spring Force at Work. Stroke:** 0,5 N (1.8oz)  
**alternative:** 3,0 N (10.8oz); 5,0 N (18.1oz)

### Materials

**Plunger:** BeCu , nickel-plated  
**Barrel:** Steel, gold-plated or Stainless Steel  
**Spring:** Brass, gold-plated  
**Receptacle:** KS-113 23

### Mounting Hole Size

see GKS-113 (Page 58)

## GND Probe GKS-414

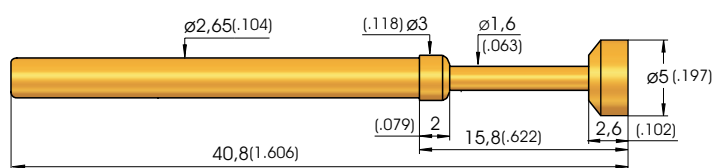

### Ordering Example

GKS for Install. Height 15,8 mm (.622):

G	K	S	4	1	4	2	0	2	5	0	0	A	1	5	0	2
---	---	---	---	---	---	---	---	---	---	---	---	---	---	---	---	---

### Mechanical Data

**Working Stroke:** 9,6 mm (.378)  
**Maximum Stroke:** 11,2 mm (.441)  
**Spring Force at Work. Stroke:** 1,5 N (5.4oz)  
**alternative:** 3,0 N (10.8oz)  
**Recaptacle:** KS-113 23 (see Page 56)

### Mounting Hole Size

see GKS-113 (Page 58)



# Customizing Accessories (Excerpt)

## Marking Units

The INGUN Marking Units excel themselves with their sturdiness, compact size, simple assembly and their long-life. We offer various types to support all Fixture designs and concepts. Please note that the Engraver must be mounted vertical to the surface which is to be marked.

## Screwing Units for Potentiometer Adjustment

The compact, manual or automatic-driven, Screwing Units enables potentiometer adjustment. The automatic Screwing Unit is driven by means of a flexible shaft, which allows an individual and compact mounting of the drive engine. The threaded section and the mounting holes in the housing enables multiple assembly possibilities in the Test Fixture. The automatic Screwing Unit is designed modularly – offering problem-free adaption of the Unit in regard to the various insertable tips and the special customer demands. The insertable tip itself is spring-loaded bedded.

### Electric-driven Marking Units

**Part No. 24447** Marking Unit-short with scratching Engraver, Ø 12 x 60 mm (SW 14), 12 V, Ø Circle 2 mm, Marking of hard surfaces (e.g. FR4, CEM1, etc.)



Marking

**Part No. 25251** Marking Unit-short with cutting Engraver Ø 12 x 60 mm (SW 14), 12 V, Ø Circle 2 mm, Marking of soft surfaces (e.g. labels, hardwood, etc.)



Marking

**Part No. 24456** Marking Unit-long with scratching Engraver, Ø 12 x 100 mm (SW 14), 12 V Ø Circle 2 mm, Marking of hard surfaces (e.g. FR4, CEM1, etc.)



Marking

### Automatic Screwing Unit

**Part No. 27791** Body of Potentiometer Screwing Unit

**Part No. 27790** Replacable Unit without insertable tip

Individual insertable tip on request. Max. stroke approx. 4.0 mm, applied force by max. stroke approx. 1 N

### Manual Screwing Unit

**Part No. 17049** Manual Screwing Unit, cross-head and flat-head tip including

### Manual Key/Button activation

**Part No. 19637** Manual Key/Button activation



Marking Unit-short (Part No. 24447)



Marking Unit-short (Part No. 25251)



Marking Unit-long (Part No. 24456)



Automatic Screwing Unit



Manual Screwing Unit



Manual Key/ Button activation

### Pneumatic-driven Marking Units

**Part No. 25241** Marking Unit with cutting Engraver Ø 16 x 57 mm (SW 19), 0.6 MPa, Ø Circle 2 mm, Marking of hard surfaces (e.g. FR4, CEM1, etc.)



Marking

**Part No. 29483** Marking Unit with milling Engraver Ø 16 x 57 mm (SW 19), 0.6 MPa, Ø Circle area with approx. Ø 1.0 to Ø 2.0 mm, Marking of hard and soft surfaces



Marking



Marking Unit (Part No. 25241)



Marking Unit (Part No. 29483)

### Pylon Receiver

The Pylon Receiver from INGUN can be loaded with all INGUN Interface Blocks.



**Part No. 32162**  
 INGUN Pylon-Receiver  
 (10 Interface Blocks) with  
 extended contacting stroke  
 (Further information see on  
 page 47)

### High-frequency Block 16-pole (2 GHz)



**S-RC-016-2GHz-16**  
 Part No. 34581  
 Loaded with:  
 HFS-810 305 051 A 5306  
**S-ATS-016-2GHz-16**  
 Art.-Nr. 39524  
 Loaded with: SB-810 Z  
 Self-centering: ± 0.2 mm

### High-frequency Block 16-pole (4 GHz)



**S-RC-016-4GHz-16**  
 Part No. 34996  
 Loaded with:  
 HFS-840 305 051 A 5306  
**S-ATS-016-4GHz-16**  
 Part No. 34571  
 Vollbestückt mit: SB-810 Z  
 Selbstzentrierung: ± 0,2 mm

### Interface Blocks

Interface Blocks, loaded with INGUN Test Probes, guarantee best contacting quality and low contact resistance. The INGUN Interface Blocks are used in the Intermediate Interfaces of the INGUN Interchangeable Fixture Kits (e.g. MA 21xx-Series) as well as in external Interfaces (e.g. Rohde&Schwarz, TestStation GR). The Working space is 15.1 ± 0.5 mm.

The in general not loaded RC- and ATS-High-frequency Blocks, prepared for loading of up to 16 High-frequency Test Probes respectively up to 16 Contact Terminals, can be loaded individually with only 1 to max. 16 Test Probes respectively Contact Terminal. Further information see our Product-information of the INGUN Interface Blocks.

### Signal Block 170-pole (4 A)



**S-RC-170-4A**  
 Part No. 27616  
 Loaded with:  
 GKS-945 357 106 A 1100  
**S-ATS-170-06**  
 Part No. 13515  
 Loaded with:  
 KT-158 06

### Signal Block 170-pole (4 A) Low Ohm



**S-RC-170-N-4A**  
 Part No. 31006  
 Loaded with:  
 HSS-118 317 175 A 1102  
**S-ATS-170-06**  
 Part No. 13515  
 Loaded with:  
 KT-158 06

### Optical wave-guide Block 45-pole



**S-RC-045-LWL**  
 Part No. 27618  
 Loaded with: KS-004 35 G-K  
 Without: LWL (Part No. 20747)  
**S-ATS-045-LWL**  
 Part No. 29448  
 Loaded with: KS-004 35 G-K  
 Without: LWL (Part No. 20747)

### Optical wave-guide Block 20-pole for Feasa OH-3



**S-RC-020-LWL-F**  
 Part No. 38696  
 Not loaded, loadable with e.g.:  
 20x Feasa OH-3 (Part  
 No. 33685)  
**S-ATS-045-LWL**  
 Part No. 29448  
 Loaded with: KS-004 35 G-K  
 Without: LWL (Part No. 20747)

### High-current Block 24-pole (24 A)



**S-RC-24-24A**  
 Part No. 27628  
 Loaded with:  
 HSS-120 317 300 A 2202 M  
**S-ATS-24-10**  
 Part No. 27620  
 Loaded with:  
 KT-120 L3 E02-30

### High-current Block 2-pole (50 A)



**S-RC-002-50A**  
 Part No. 31549  
 Loaded with:  
 HSS-150 317 300 A 5002 M  
**S-ATS-002-50**  
 Part No. 31550  
 Loaded with:  
 KT-150 L3 E03-M3

### Pneumatic Block 8-pole RC-block self closing



**S-RC-008-PK3-G**  
 Part No. 37820  
 Loaded with: Connector female  
 (Part No. 37819)  
**S-ATS-008-PK3-G**  
 Part No. 37821  
 Loaded with: Connector  
 male (Part No. 37818)

For Further Interface Blocks  
 see our Product Information  
 INGUN Interface Blocks.



**Contacting of RJ-Plugs and USB-Connectors**

For contacting RJ- and USB-Plugs with little wear and resistance INGUN offers especially designed and manufactured test plugs, which are manufactured with robust copper-beryllium wires Tooling Pins.

RJ-Plugs	
Part No. 17824	RJ-10, 4-channels
Part No. 17825	RJ-12, 6-channels
Part No. 17826	RJ-45, 8-channels
Part No. 17827	RJ-48, 10-channels
USB Test Plugs	
Part No. 17829	USB Test Plug, 4-channels, type B
Part No. 21072	USB Test Plug Mini, 5-channels, type B
Part No. 34816	USB Test Plug Micro, 5-channels, type B

Mounting Shoes are available for the assembly of all Test Plugs.  
Further variations of test plugs are available on request.

**Tooling Pins**

**Rigid Tooling Pins**

The Tooling Pins from INGUN register the PC-Board in the applicable Tooling Pin Holes and therefore guaranty an exact registration of the PC-Board on the Test Fixture. The Tooling Pins are available with diameters from 1.9 to 5 mm and in steps of 0.1 mm. They have a tolerance of 0 /-0.05 mm.

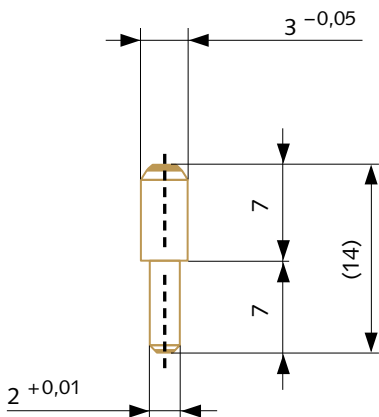

**Spring-loaded Tooling Pins GFS-874**

To enable high-precision customizing INGUN offers spring-loaded Tooling Pins. In this case the PC-Board is registered via a conical-shaped, spring-loaded Tooling Pin. To customize the Fixture you need a pair of Tooling Pins, i.e. consisting of one cone-shaped Tooling Pin and one dagger-shaped Tooling Pin.



**For Tooling Pin Holes:**

**Ø 2.0 mm to Ø 3.5 mm**

Part No. 24481 cone-shaped

Part No. 25214 dagger-shaped

**For Tooling Pin Holes:**

**Ø 3.5 mm to Ø 5.5 mm**

Part No. 25215 cone-shaped

Part No. 25217 dagger-shaped

*Spring-loaded Tooling Pins as a pair (Dagger and Cone-shaped)*

Further special Tooling Pins are available – such as e.g. Tooling Pins with mounting disk, Special Tooling Pins for In-line Systems (e.g. with optical safety check or spring-loaded)

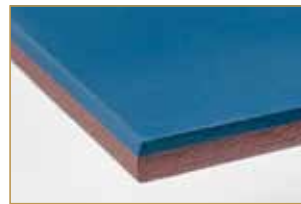

**Cleaning Mats**

PC-Boards often show signs of flux deposits and oxide layers, which contaminate the surface and create an insulating layer. With the increased

usage of the Test Probes the deposits are transferred to the tips of the Test Probes. INGUN proposes cleaning the tips of the Probes with a Cleaning Mat.

Cleaning is recommended for those tip-styles with self-cleaning features, e.g. 01, 09, 15, 31, 38, 77, 91, 93, 97, 98. Contact Cleaning Mats can used on all INGUN Test Fixtures without Pressure Frames and are available in various sizes. Sizes and prices on request!

Further details – also in regard to Cleaning Brushes – can be found on the applicable Product Data Sheets.

# Insertion and Extraction Tools

Insertion and Extraction Tools enable Test Probes and Receptacles to be inserted and extracted safely, easily and without being damaged. The Insertion Tools are generally equipped with a Handle (SW-H) and an interchangeable Bit. The Bit being in accordance to the specific probe series (e.g. E-SW KS-112).

Tools which can be adjusted in a variable manner are available for Receptacles with a Press-ring for the series GKS-050, GKS-075 and GKS-100. When inserting the Receptacle, the Press-ring is pressed into the mounting hole; the Installation Height of the Test Probe can then be adjusted to meet the applicable application.

Tools for screw-in Probes: see from page 170/171.

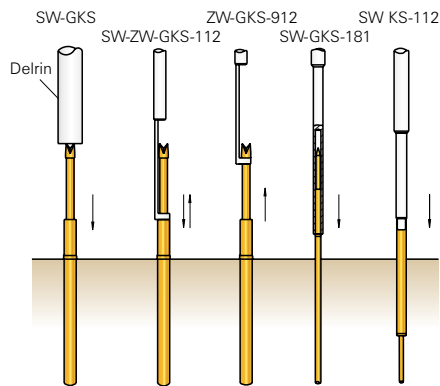

# Insertion and Extraction Tools

SW / ZW / AW **NEW**

118

**Tool for assembling Screw-in Probes – see pages 170–171**

# Insertion and Extraction Tools

NEW

Series	Insertion Tool for GKS	Insertion and Extraction Tool for GKS Tip-Ø > Shaft-Ø	Insertion Tool for KS
GKS-001	SW-GKS		
GKS-002	SW-GKS	SW-ZW-GKS-100	SW-KS 100 / SW-KS-100 G <sup>(4)</sup>
GKS-003	SW-GKS		SW-KS-102
GKS-004	SW-GKS		
GKS-005	SW-GKS		
XXX-050	SW-GKS-081 <sup>(1)</sup>		SW-KS-050 G <sup>(4)</sup>
GKS-069	SW-GKS-187 B		SW-KS-080
XXX-075		SW-ZW-GKS-075	SW-KS-075 G <sup>(4)</sup>
GKS-080		SW-ZW-GKS-080	SW-KS-080
GKS-081	SW-GKS-081 <sup>(1)</sup>		SW-KS-080
GKS-098	SW-GKS		SW-KS-103
XXX-100	SW-GKS-100 B <sup>(1)</sup>	SW-ZW-GKS-100	SW-KS 100 / SW-KS-100 G <sup>(4)</sup>
GKS-101		SW-ZW-GKS-101	SW-KS-101
GKS-102		SW-ZW-GKS-112	SW-KS-102
GKS-103		SW-ZW-GKS-103	SW-KS-103
GKS-112		SW-ZW-GKS-112	SW-KS-112
GKS-113		SW-ZW-GKS-103	SW-KS-113
GKS-135	SW-GKS-100 B <sup>(1)</sup>	SW-ZW-GKS-100	SW-KS 100 / SW-KS-100 G <sup>(4)</sup>
GKS-181	SW-GKS-181 <sup>(1)</sup>	ZW-GKS-912	SW-KS-181
GKS-204	SW-GKS-912 A <sup>(2)</sup> / 912 B <sup>(3)</sup>	ZW-GKS-912	SW-KS-112
GKS-412		SW-ZW-GKS-112	SW-KS-112
XXX-422	SW-GKS-912 A <sup>(2)</sup> / 912 B <sup>(3)</sup>	ZW-GKS-912	SW-KS-112
GKS-502		SW-ZW-GKS-112	SW-KS-102
GKS-503		SW-ZW-GKS-103	SW-KS-103
GKS-550	SW-GKS-181 <sup>(1)</sup>		SW-KS-050 G <sup>(4)</sup>
GKS-710		ZW-GKS-912	SW-KS-112
GKS-713	SW-GKS		SW-KS-113
GKS-714	SW-GKS		SW-KS-113
GKS-725		SW-ZW-GKS-100	SW-KS-100
GKS-912	SW-GKS-912 A <sup>(2)</sup> / 912 B <sup>(3)</sup>	ZW-GKS-912	SW-KS-112
GKS-913		SW-ZW-GKS-103	SW-KS-113
GKS-967	SW-GKS		SW-KS-102
HSS-118		SW-ZW-GKS-112	SW-KS-112
HSS-120		SW-ZW-GKS-103	SW-KS-113
HSS-150	SW-GKS		
PKS-200/220	SW-GKS		SW-KS-102
PKS-300/299	SW-GKS		SW-KS-103
SKS-100		SW-ZW-GKS-100	SW-KS-100 G <sup>(4)</sup>
SKS-215		SW-ZW-GKS-112	SW-KS-112
SKS-415/425		SW-ZW-GKS-103	SW-KS-113
SKS 419/429	SW-SKS-419-429-300		
SKS 419/429	SW-SKS-419-429-500		

<sup>(1)</sup> Insertion Tool for Plunger with continuous Shaft  
<sup>(3)</sup> for Tip Style „09“

<sup>(2)</sup> universal usage  
<sup>(5)</sup> Extraction Tool

<sup>(4)</sup> free adjustable

**Note:**

Tools for Screw-in Test Probes page 170/171.  
Tools for RF-Probes can be found in our present RF Catalog .

## Ordering Example

Insertion and Extraction Tools for GKS 112:

SW - ZW - GKS - 112

Insertion Tools for GKS 912:

SW - GKS - 912 A or SW - GKS - 912 B

Bits for Insertion tools GKS 912:

E - SW - GKS - 912 A or E - SW - GKS - 912 B

Extraction Tool for Receptacles:

AW - KS - Set - ICT

**SW-GKS:** Universal Insertion Tool for GKS

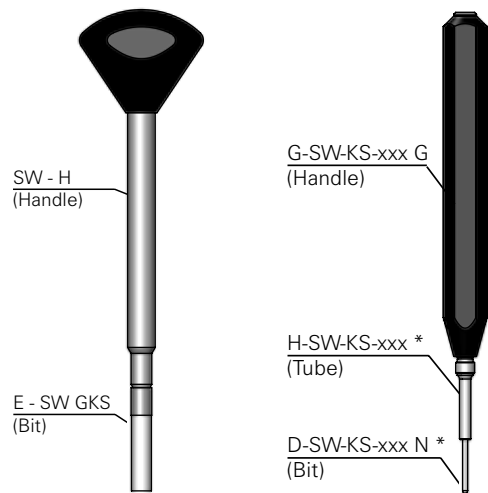

**SW-KS-xxx G (4):** Variably adjustable Insertion Tool, for Receptacle with Press-ring (\* can be purchased individually)

**AW-KS-Set-ICT:** Extraction Tool for KS (ICT)

NEW

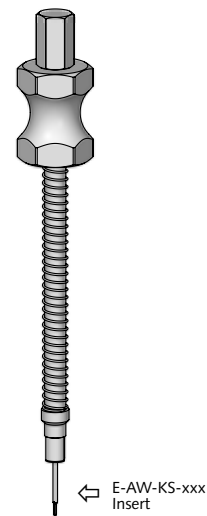

The Set for extraction of Receptacles contains the Bits E-AW-KS-xxx for Test Probe series GKS-040/050/075/100:

Extraction Tool for Set ICT	AW-KS-Set-ICT
Bit for KS-040 (Spare Part)	E-AW-KS-040
Bit for KS-050 (Spare Part)	E-AW-KS-050
Bit for KS-075 (Spare Part)	E-AW-KS-075
Bit for KS-100 (Spare Part)	E-AW-KS-100

# Cable Harness Test Probes

Screw-in Test Probes

---

Screw-in High-current Probes

---

Screw-in Switching Probes

---

RF/Digital

---

Non-rotating Probes

---

Push-back Probes

---

Tools



# Test Probes for Cable Harness Testing

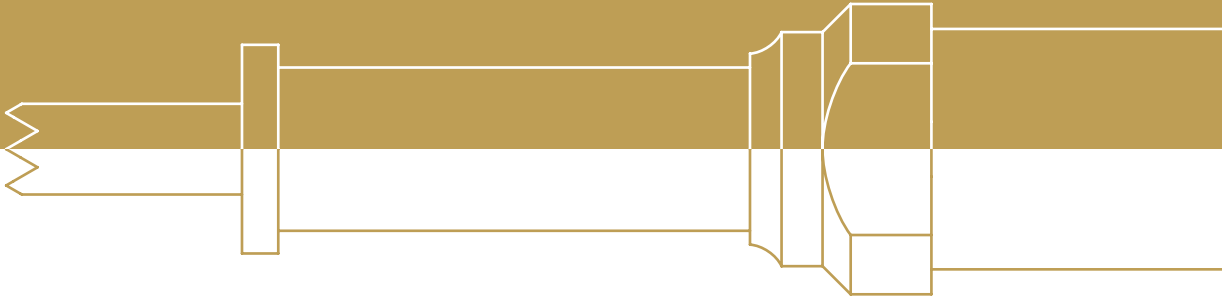

# Contents: Cable Test Probes

Grid in mm (MII)	Recommended Stroke in mm	Max. Stroke in mm	Current Rating in A	ICT / FCT	Combined ICT-/FCT-Test	Cable Harness Probes	Solderable Probes	Battery Probes	Micro-Contacting	RF-Applications	High-Current Applications	High Temperature Range	Component Presence Check	Individually controllable Probes	Interface Probes	Low Installation Height	High Installation Height	Short-stroke Probes	Long-stroke Probes	Through (continuous) Plunger	Non-Rotating Probes	Rotating Probes	High Spring Forces	Stroke-measurement Probes	Series	Page	
<b>Screw-in Test Probes</b>																											
1,27	4,3	6,35	3			•						•													GKS-050 M	126	
1,27	4	5	3			•										•									GKS-087 M	127	
1,91	4,3	6,35	4			•						•	•												GKS-075 M	128	
2,54	3,5	4,5	5 – 8			•										•									GKS-427 M	129	
2,54	3,5	4,5	16			•					•	•				•									HSS-827 M	129	
2,54	3,5	4,4	3 – 5			•										•									GKS-899 M	130	
2,54	3,5	4,4	3 – 5			•																			T-899 M	131	
2,54	4	5,3/8	5 – 8			•						•	•										•		GKS-112 M	132	
2,54	4	5	5 – 8			•																	•		T-112 M	133/134	
2,54	4	5	5 – 8			•																	•		T-912 M	133/134	
4	4	5,3	5 – 8			•						•												•		GKS-113 M	135
4	4	5	5 – 8			•																	•		T-113 M	136/137	
4	4	5	5 – 8			•																		•		T-888 M	136/137
5,08	4,4	5,5	10 – 12			•						•													GKS-854/854M	138	
4,5	5,6	7	5 – 15			•					•												•		GKS-500 M	139	
2,54	12	14,5	2 – 3			•																			GKS-212 M	140	
5,08	12	14,3	3 – 5			•																			GKS-313 M	141	
4	2,8	3,5	5 – 8			•										•		•							GKS-913 M	142	
<b>Screw-in High-current Probes</b>																											
2,54	4	5,3/8	16			•					•	•														HSS-118 M	144
4	4	5,3	24			•					•	•														HSS-120 M	145
5,08	4,4	5,5	50			•					•	•											•			HSS-150 M	146
5,08	2	2,5	50			•					•	•			•		•									HSS-552 M	146
<b>Screw-in Switching Probes</b>																											
2,54	4	5	3			•							•													SKS-215 M/MF	148
3,5	4	5,2	3			•							•										•			SKS-465 MF	149
3,5	4	4,5	3			•							•										•			SKS-465 SF	150
4,5	8	6	3			•							•			•							•			SKS-435 M	151
<b>RF/Digital</b>																											
						•				•																HFS	152/154
<b>Non-rotating Probes</b>																											
4,5	6,4	8	5 – 15			•					•											•	•	•		GKS-803 M	156
2,54	4	5	5 – 8			•																				GKS-710	157
5,08	4/6	5/7	8 – 10			•																				GKS-714	158
5,08	4	5	8 – 10			•																				GKS-098	158
5,08	4	5	8 – 10			•																				GKS-098 M	159
2,54	4	4,4	8 – 10			•																				GKS-746 M	160
4	4	5	8 – 10			•																				GKS-747 M	161
<b>Push-back Probes</b>																											
2,54	5	6	5			•										•						•	•	•		VF 25	164
3	5	5,5	8			•										•						•	•	•		VF 3	165
4	5	7	8			•					•					•						•	•	•		VF 4	166
5	9,5	12	10			•					•					•		•				•	•	•		VF 5	167
<b>Screw-in Tools for screw-in Probes</b>																											
<b>Tools</b>																											
																										BIT/DW/SW	170/171

# Test Probes for Cable Harness Testing

Due to the progressive development in the automobile industry the complexity of the Cable Harnesses is also increasing. To meet these demands INGUN has extended the range of variants of standard Cable Harness Test Probes. Apart from the renowned series the range of Screw-in and Step-Probes, Push-back Probes, High-current Probes and the choice of Kelvin/RF Probes has been enhanced.



The following Test Probes are mainly used for testing Cable Harnesses and Connectors. Especially the Screw-in Probes (with end index "M") and the Push-back Probes (VFxx) offer an optimal reliability against the creeping out of the Test Probe out of the Receptacle.

Screw-in variants are also available within various standard series. Further special designs and variants are available on request.

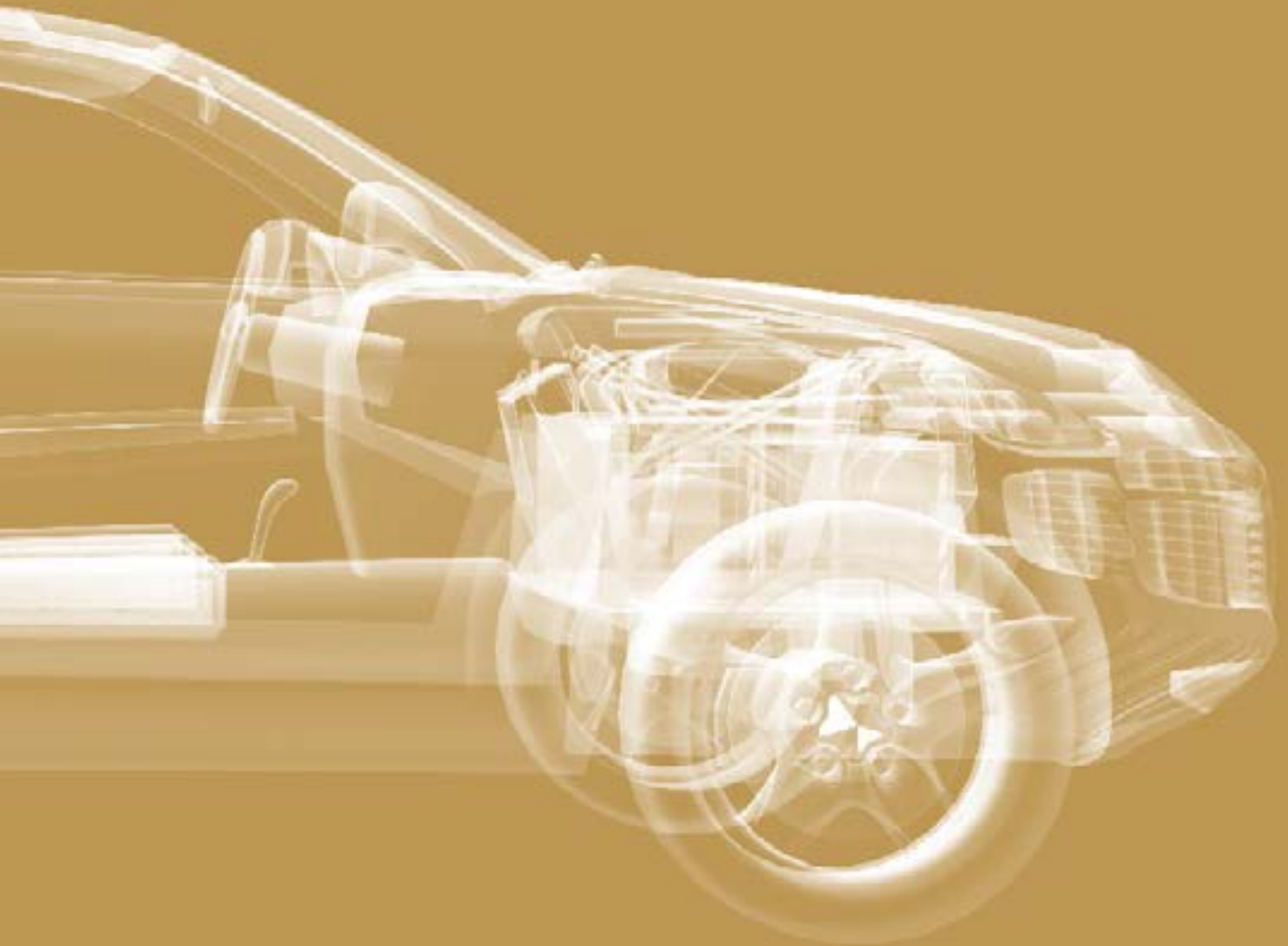

# Notes

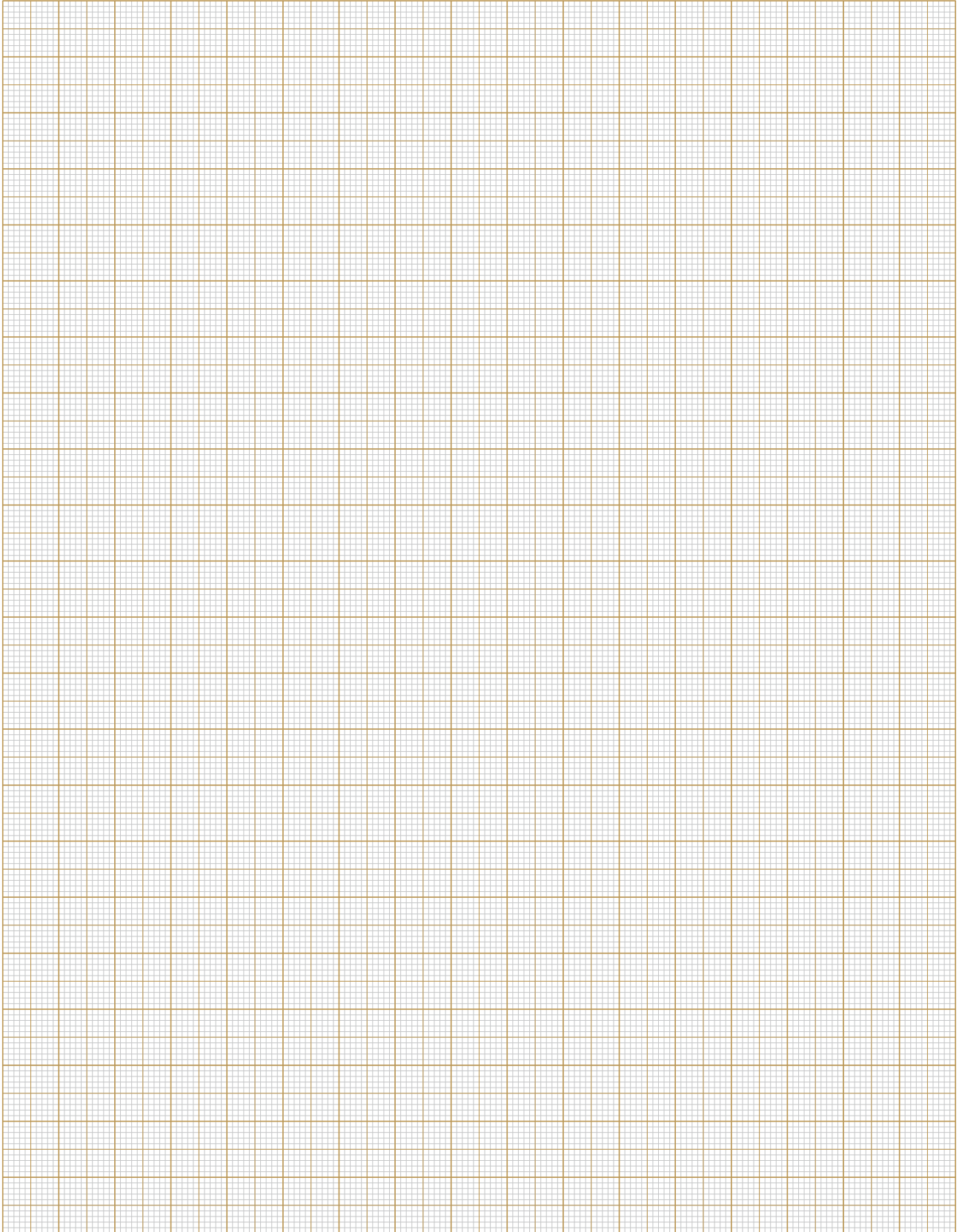

# Screw-in Test Probes

Screw-in Test Probes are always marked with the end index „M“. They are mainly used for testing Cable Harnesses and Connectors in Cable Test Tables. The Test Probe, which has the thread on the bottom end, is screwed into the Receptacle (that has the applicable internal thread) using a special screwing tool (see page 170/171).

The screw connection ensures that the Test Probe has a secure hold in the Receptacle even under difficult application conditions (i.e. snapping effect, assembly upside down etc.). Furthermore, a flexible exchange of the Test Probe is also guaranteed.

Spring-Loaded Test Probe (GKS) and Receptacle (KS) for screw-in connection (GKS and KS with thread)

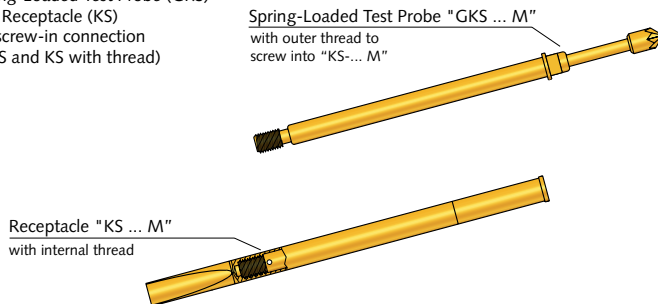

# Screw-in Test Probes

GKS-050 M		126
GKS-087 M		127
GKS-075 M		128
GKS-427 M		129
HSS-827 M		129
GKS-899 M		130
T-899 M		131
GKS-112 M		132
VS-112 M		132
T-112 M	NEW	133/134
T-912 M	NEW	133/134
GKS-113 M		135
T-113 M	NEW	136/137
T-888 M	NEW	136/137
GKS-854/854 M		138
GKS-500 M		139
GKS-212 M		140
GKS-313 M		141
GKS-913 M		142
GKS-204 M		55
GKS-103 M		60
GKS-503 M		61
GKS-967 M		68
GKS-761 M		69

Insertable Test Probes GKS from page 17 on.



# GKS 050 M

Screw-in Test Probe

**Grid:**

≥ 1,27 mm

≥ 50 Mil

**Installation Height:** 10,5 / 12,5 mm (.413 - .492)

**Recommended Stroke:** 4,3 mm (.169)

## Mounting and Functional Dimensions

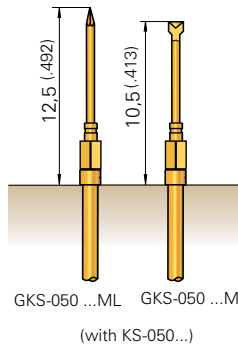
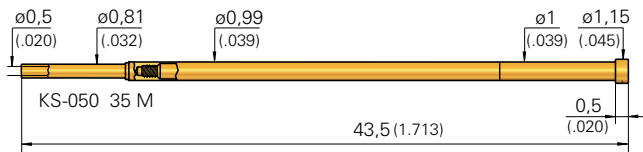
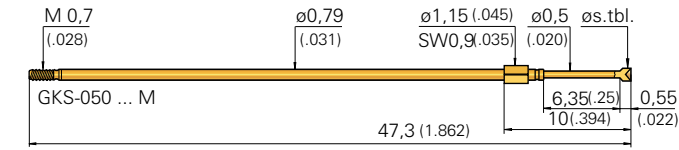

### Collar Height and Installation Height

The Installation Height of the Tip (measured with the Receptacle) is determined by the Collar Height of the Receptacle.

Collar Height	Installation Height
03 M	10,5 mm (.413)
03 ML	12,5 mm (.492)

### Mechanical Data

**Working Stroke:** 4,3 mm (.169)  
**Maximum Stroke:** 6,35 mm (.250)  
**Spring force at Work. Stroke:** 1,5 N (5.4oz)  
**alternative:** 1,0 N (3.6oz); 2,0 N (7.2oz)

### Electrical Data

**Current Rating:** 2 - 3 A  
**R<sub>j</sub> typical:** < 20 mΩ (\*\* < 100 mΩ)

### Operating Temperature

**Standard:** -40° up to +80° C  
**\*\*with Spec. Designation "MC":** -100° up to +200°C (2,0 N)

### Materials

**Plunger:** BeCu or Steel, gold-plated  
**Barrel:** Brass, gold-plated  
**Spring:** Steel, gold-plated or Stainless Steel\*\* (MC)  
**Receptacle:** Brass, gold-plated

### Mounting Hole Size

**in CEM 1:** ø1,00 - 1,02 mm (.0394-.0401)  
**in FR 4:** ø1,01 - 1,03 mm (.0398-.0405)

### Note:

The Receptacle KS-050 ... M is available pre-wired with 1 m Wire AWG 30 (see Ordering Example).

## Available Tip Styles

Material	Tip Style	Plating	Further Versions	
			∅	∅ (inch)
NEW 2 01		A	∅ 0,50 (.020)	
NEW 3 02		A	∅ 0,60 (.023)	
3 03		A	∅ 0,50 (.020)	0,90 (.035)
3 05		A	∅ 0,50 (.020)	
3 06		A	∅ 0,90 (.035)	
NEW 3 07		A	∅ 0,50 (.020)	0,90 (.035)
2 14		A	∅ 0,50 (.020)	
2 22*		A	∅ 0,40 (.020)	
2 31		A	∅ 0,50 (.020)	
2 38		A	∅ 0,50 (.020)	
2 77		A	∅ 0,50 (.020)	
2 91		A	∅ 0,50 (.020)	
2 97		A	∅ 0,50 (.020)	

\* conical down to ∅ 0,50 mm

## Available Tip Styles

Special Version GKS-050 ... ML

Material	Tip Style	Plating	Further Versions	
			∅	∅ (inch)
2 91		A	∅ 0,50 (.020)	

Total Length 49,3 mm (1.941), Special Designation „ML“

### Note:

GKS-050 ... M will be screwed into KS-050 ... M using special tools, see Page 170/171.

Recommended Screw-in Torque:  
 Min.: 0,5 Ncm / Max.: 1 Ncm

## Ordering Example

Series	Tip Material	Tip Style	Tip Diameter (1/100 mm)	Plating	Spring Force (dN)	Collar Height (mm)	Special Designation „MC“
G K S	2 = Steel 3 = BeCu	0 5 0	2 9 1	0 5 0	A	1 5 0 3	M
Test Probe with Total Length 47,3 mm (1.862):							
Receptacles:							
KS - 0 5 0 3 5 M    KS - 0 5 0 3 5 M - V - 30							
Insertion Tool for KS-050 ... M:							
S W - K S - 0 8 0							

Grid:  
 ≥ 1,27 mm  
 ≥ 50 Mil

Installation Height: 7,2 / 8,2 mm (.283 / .323)  
 Recommended Stroke: 4,0 mm (.157)

### Mounting and Functional Dimensions

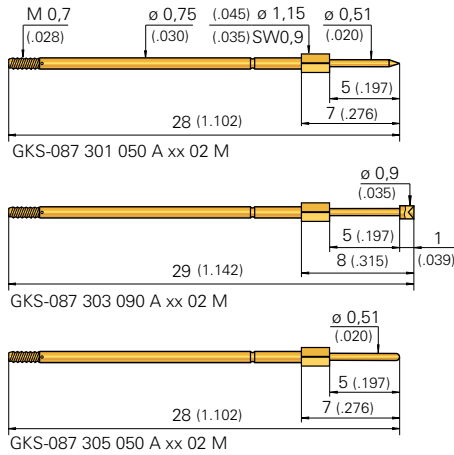

### Available Tip Styles

Material	Tip Style	Plating	Further Versions	
			∅	∅ (inch)
3 01		A	∅ 0,50 (.020)	
3 03		A	∅ 0,90 (.035)	
3 05		A	∅ 0,50 (.020)	

### Receptacles

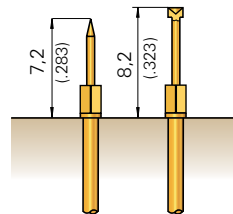
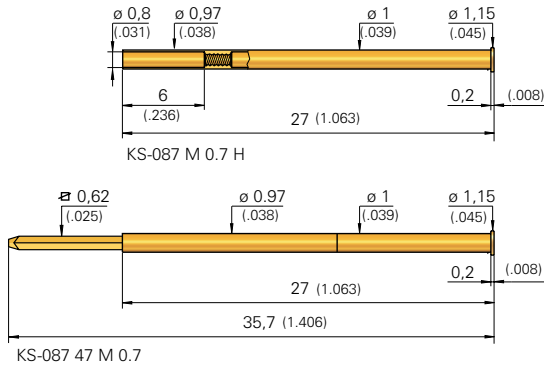

GKS-087 ... M GKS-087 303 ... M  
 (with KS-087...)

### Collar Height and Installation Height

The Installation Height of the Tip (Dimension with Receptacle) is determined by the Collar Height and the Tip Style. The Collar Height of the series GKS-087 is always 02.

Collar Height	Tip Style	Diameter	Installation Height
02 M	01	0,50 (.020)	7,2 mm (.283)
02 M	03	0,90 (.035)	8,2 mm (.323)
02 M	05	0,50 (.020)	7,2 mm (.283)

### Mechanical Data

**Working Stroke:** 4,0 mm (.157)  
**Maximum Stroke:** 5,0 mm (.197)  
**Spring Force at Work. Stroke:** 0,5 N (1.8oz)  
**alternative:** 0,8 N (2.9oz)

### Electrical Data

**Current Rating:** 2 - 3 A  
**R<sub>i</sub> typical:** < 20 mΩ

### Materials

**Plunger:** BeCu, gold-plated  
**Barrel:** Brass, gold-plated  
**Spring:** Steel, gold-plated  
**Receptacle:** Brass, gold-plated

### Mounting Hole Size

**in CEM 1:** ∅1,00 - 1,02 mm (.0394-.0401)  
**in FR 4:** ∅1,01 - 1,03 mm (.0398-.0405)

### Operating Temperature

**Standard:** -40° up to +80° C

### Note:

GKS-087 ... M will be screwed into KS-087 ... M using special tools, see Page 170/171.

Recommended Screw-in Torque:  
 Min.: 0,5 Ncm / Max.: 1 Ncm

### Ordering Example

Series	Tip Material	Tip Style	Tip Diameter (1/100 mm)	Plating	Spring Force (dN)	Collar Height (mm)	Special Designation
	3 = BeCu			A = Gold			

Test Probe:

G K S 0 8 7 3 0 5 0 5 0 A 0 5 0 2 M

Receptacles:

K S - 0 8 7 M 0,7 H    K S - 0 8 7 4 7 M 0,7

# GKS 075 M

Screw-in Test Probe

**Grid:**

≥ 1,91 mm

≥ 75 Mil

**Installation Height:** 10,5 mm (.413)

**Recommended Stroke:** 4,3 mm (.169)

## Mounting and Functional Dimensions

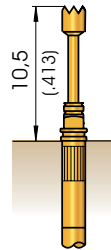
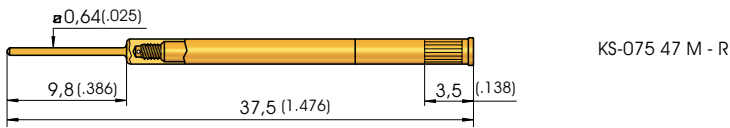
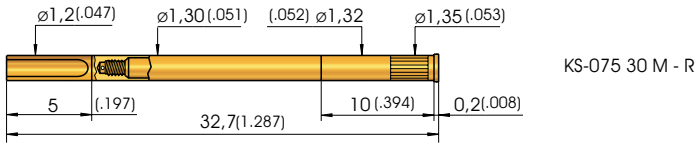
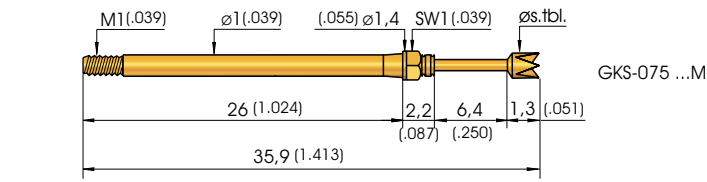

### Collar Height and Installation Height

The Installation Height of the Tip is 10,5 mm (.413). The Test Probe can only be used with a Receptacle.

### Mechanical Data

**Working Stroke:** 4,3 mm (.169)  
**Maximum Stroke:** 6,35 mm (.250)  
**Spring Force at Work. Stroke:** 2,0 N (7.2oz)  
**alternative:** 0,6 N (2.2oz); 1,0 N (3.6oz); 1,5 N (5.4oz); 2,8 N (10.1oz)

### Electrical Data

**Current Rating:** 3 - 4 A  
**R<sub>j</sub> typical:** < 20 mΩ (\*\* < 100 mΩ)

### Operating Temperature

**Standard:** -40° up to +80° C  
**\*\*with Spec. Desig. "MC":** -100° up to +200° C (2,0 N; 2,8 N)

### Materials

**Plunger:** BeCu or Steel, gold-plated  
**Barrel:** Brass, gold-plated  
**Spring:** Steel, gold-plated or Stainless Steel \*\* (MC)

### Mounting Hole Size

**in CEM 1 and FR 4:** ø 1,32 - 1,34 mm (.0520 - .0528)

### Note:

GKS-075 ... M will be screwed into KS-075 ... M using special tools, see Page 170/171.

**Recommended Screw-in Torque:**  
 Min.: 0,5 Ncm / Max.: 1 Ncm

## Available Tip Styles

Material	Tip Style	Plating	Further Versions	
			ø	ø (inch)
0 06*		A	ø 1,30 (.051)	
2 01		A	ø 0,64 (.025)	
NEW 3 02		A	ø 0,90 (.040)	
3 03		A	ø 1,20 (.047)	
2 04		A	ø 1,15 (.045)	
3 05		A	ø 0,50 (.020)	
3 05		A	ø 0,64 (.025)	
3 06		A	ø 1,00 (.039)	1,20 (.047)
2 07		A	ø 0,64 (.025)	1,00 (.039) 1,20 (.047)
2 09		A	ø 0,64 (.025)	
3 13		A	ø 0,61 (.024)	
2 14		A	ø 0,50 (.020)	0,64 (.025) 0,80 (.031) 1,00 (.039)
2 17		A	ø 1,20 (.047)	
NEW 3 19		A	ø 1,20 (.047)	1,50 (.059)
2 24***		A	ø 1,30 (.051)	
2 25		A	ø 1,20 (.047)	1,30 (.051)
2 31		A	ø 0,64 (.025)	
2 77		A	ø 0,64 (.025)	
2 91		A	ø 0,64 (.025)	
2 97		A	ø 0,64 (.025)	0,80 (.031)
2 98		A	ø 0,64 (.025)	

\* Tip Height: 2,8 mm (.110), Total Length GKS 1,5 mm (.059) longer than Standard

Further Tip Styles see GKS-075, Page 26/27

\*\*\* higher middle tip plus 0,2 mm

## Ordering Example

Series	Tip Material 2 = Steel 3 = BeCu	Tip Style	Tip Diameter (1/100 mm)	Plating A = Gold	Spring Force (dN)	Collar Height (mm)	Special Designation alternative „MC“
--------	---------------------------------------	-----------	----------------------------	---------------------	----------------------	-----------------------	--

Test Probe:

G K S 0 7 5 2 0 1 0 6 4 A 1 5 0 2 M

Receptacles for GKS-075 ... M:

K S - 0 7 5 3 0 M - R    K S - 0 7 5 4 7 M - R

**Grid:**  
 ≥ 2,54 mm  
 ≥ 100 Mil

**Installation Height:** 8,7 mm (.343)  
**Recommended Stroke:** 3,5 mm (.138)

### Mounting and Functional Dimensions

#### GKS-427 M

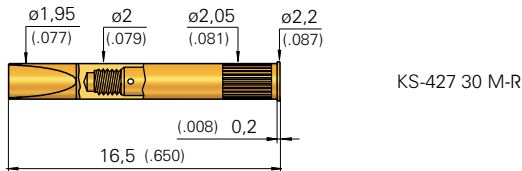
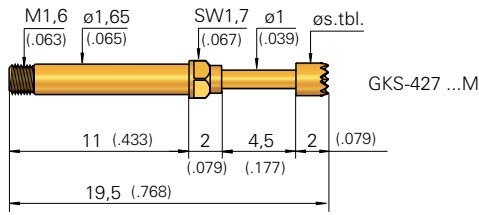

#### HSS-827 M

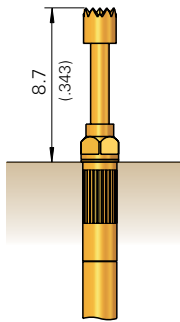
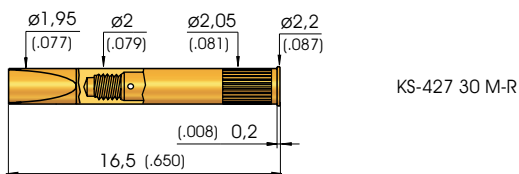
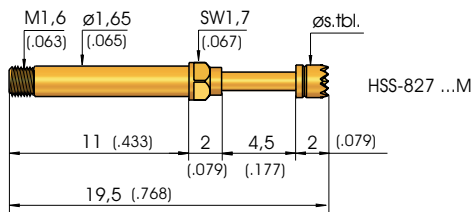

#### Available Tip Styles GKS 427 M

Material	Tip Style	Plating	Further Versions	
			∅	∅ (inch)
2 01		A		
3 06		A		

#### Available Tip Styles HSS 827 M

Material	Tip Style	Plating	Further Versions	
			∅	∅ (inch)
3 02		S		
3 06		A		

#### Collar Height and Installation Height

The Installation Height of the Tip is always 8,7 mm (.343). The Test Probe can only be used with a Receptacle.

#### Mechanical Data

**Working Stroke:** 3,5 mm (.138)  
**Maximum Stroke:** 4,5 mm (.177)  
**Spring Force at Work. Stroke:** 1,5 N (5.4oz)  
**alternative:** \*2,5 N (9.0oz)

#### Electrical Data

**Current Rating:** 5 - 8 A  
**R<sub>i</sub> typical:** < 20 mΩ

#### Operating Temperature

**Standard:** -40° up to +80° C  
**\* with Special Designation „MC“:**  
 -100° up to +200° C  
 1,5 N (5.4oz); 2,5 N (9.0oz)

#### Mounting Hole Size

**for KS-427 30 M-R**  
**in CEM 1 and FR 4:** ∅ 2,00 - 2,02 mm  
 (.0787 - .0795)

#### Materials

**Plunger:** Steel or BeCu, gold-plated  
**Barrel:** Brass, gold-plated  
**Spring:** Stainless Steel (\*MC) or Steel, gold-plated  
**Receptacle:** Brass, gold-plated

#### Electrical Data

**Current Rating:** max. 16 A  
**R<sub>i</sub> typical:** < 10 mΩ

#### Operating Temperature

**Standard:** -40° up to +80° C  
**\* with Special Designation „MC“:**  
 -100° up to +200° C  
 1,5 N (5.4oz); 2,5 N (9.0oz)

#### Note:

GKS-427 ... M will be screwed into KS-427 ... M-R using special tools, see Page 170/171.

Recommended Screw-in Torque:  
 Min.: 3 Ncm / Max.: 5 Ncm

### Ordering Example

Series	Tip Material	Tip Style	Tip Diameter (1/100 mm)	Plating	Spring Force (dN)	Collar Height (mm)	Type
	2 = Steel 3 = BeCu			A = Gold S = Silver			

Test Probe:

G K S 4 2 7 3 0 6 2 0 0 A 1 5 0 2 M

Test Probe:

H S S 8 2 7 3 0 2 2 0 0 S 1 5 0 2 M

Receptacle for GKS-427 ... M:

K S - 4 2 7 3 0 M - R

# GKS-899 M

Screw-in Step Probes

**Grid:**

≥ 2,54 mm

≥ 100 Mil

**Installation Height:** 12,8 (.504)

**Recommended Stroke:** 3,5 mm (.138)

## Mounting and Functional Dimensions

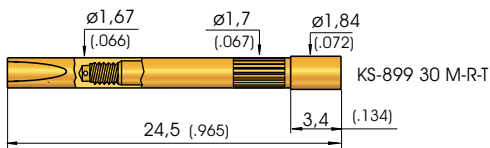
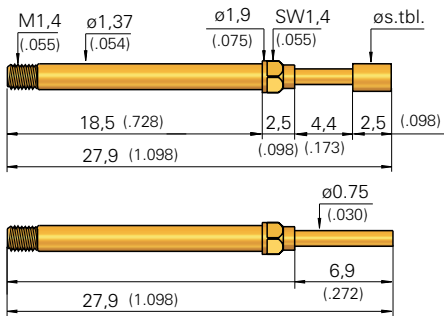

\*\* axially positioned trough-hole for leakage test. Attention: when not assembled correctly, then solder can flow inside the receptacle.

## Available Tip Styles

Material	Tip Style	Plating	Further Versions	
			∅	∅ (inch)
2	01	A	∅ 0,75 (.030)	
3	02	A	∅ 0,75 (.030)	0,65 (.026) <b>NEW</b>
3	02	A	∅ 1,50 (.059)	
3	03	A	∅ 1,80 (.071)	
3	05	A	∅ 0,75 (.030)	0,65 (.026)
3	06	A	∅ 1,30 (.051)	1,00 (.039) 1,80 (.071) <b>NEW</b>
3	13	A	∅ 0,61 (.024)	

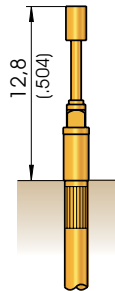

### Collar Height and Installation Height

The Installation Height of the Tip is always 12,8 mm (.504). The Test Probe can only be used with a Receptacle.

### Mechanical Data

**Working Stroke:** 3,5 mm (.138)  
**Maximum Stroke:** 4,4 mm (.173)  
**Spring Force at Work. Stroke:** 1,5 N (5.4oz)  
**alternative:** 0,7 N (2.5oz); 2,5 N (9.0oz)  
 3,0 N (10.8oz)

### Electrical Data

**Current Rating:** 3 - 5 A  
**R<sub>i</sub> typical:** < 20 mΩ

### Materials

**Plunger:** Steel or BeCu, gold-plated  
**Barrel:** Brass, gold-plated  
**Spring:** Steel, gold-plated  
**Receptacle:** Brass, gold-plated

### Mounting Hole Size

**in CEM 1 and FR 4:** ∅ 1,67 - 1,68 mm (.0657 - .0661)

### Operating Temperature

**Standard:** -40° up to +80° C

### Note:

GKS-899 ... M will be screwed into KS-899 ... M-R using special tools (see page 170/171).

Recommended Screw-in Torque:  
 Min.: 2 Ncm / Max.: 3 Ncm

## Ordering Example

Series	Tip Material 2 = Steel 3 = BeCu	Tip Style	Tip Diameter (1/100 mm)	Plating A = Gold R = Rhodium	Spring Force (dN)	Collar Height (mm)	Type
Test Probe:	G K S	8 9 9	3 0 6	1 3 0	A	1 5	0 2 M
Receptacle for GKS-899 ... M:	K S - 8 9 9 3 0 M - R - T						
Receptacle for Leakage Test **:	K S - 8 9 9 3 0 M - R						

**Grid:**  
 ≥ 2,54 mm  
 ≥ 100 Mil  
**Installation Height:** see table  
**Recommended Stroke:** 3,5 mm (.138)

## Mounting and Functional Dimensions

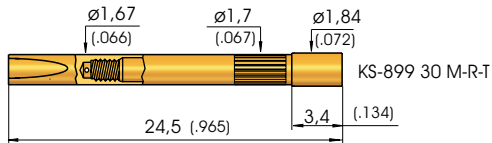
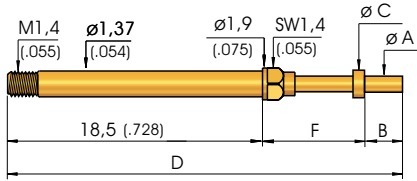

\*\* axially positioned trough-hole for leakage test. Attention: when not assembled correctly, then solder can flow inside the receptacle.

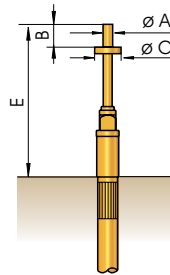

## Available Tip Styles

Material	Tip Style	Plating	Further Versions	
			Ø	Ø (inch)
3 02	Ø s. Table	A		
3 05	Ø s. Table	A		
3 05 G	Ø s. Table	A		

**Collar Height and Installation Height**  
 Installation Height see table below.  
 The Test Probe can only be used with a Receptacle.

### Mechanical Data

**Working Stroke:** 3,5 mm (.138)  
**Maximum Stroke:** 4,4 mm (.173)  
**Spring Force at Work. Stroke:** 1,5 N (5.4oz)  
**alternative:** 0,7 N (2.5oz); 3,0 N (10.8oz)

### Electrical Data

**Current Rating:** 3 - 5 A  
**R<sub>i</sub> typical:** < 20 mΩ

### Materials

**Plunger:** Steel or BeCu, gold-plated  
**Barrel:** Brass, gold-plated  
**Spring:** Steel, gold-plated  
**Receptacle:** Brass, gold-plated

### Mounting Hole Size

**in CEM 1 and FR 4:** Ø 1,67 - 1,68 mm (.0657 - .0661)

### Operating Temperature

**Standard:** -40° up to +80° C

### Note:

T-899 ... M will be screwed into KS-899 ... M-R (-T) using special tools (see page 170/171) \*.

Details of Torque Tools and Insertion Bits from page 170 on.

Recommended Screw-in Torque:  
 Min.: 2 Ncm / Max.: 3 Ncm

Part No.	A Tip-Ø mm	B Tip Length mm	C Disk-Ø mm	D Total Length mm	E Install.Height with KS mm	F Disk Height without KS mm	Working Stroke mm	Max. Stroke mm	* Tools (Insertion Bits)
T-899 302 065 210 150 A 1502 M	0,65 (.026)	2,1 (.083)	1,5 (.059)	28,0 (1.102)	12,9 (.508)	7,4 (.291)	3,5 (.138)	4,4 (.173)	BIT-GKS-899 M-B
T-899 305 065 280 150 A 1502 M	0,65 (.026)	2,8 (.110)	1,5 (.059)	28,7 (1.130)	13,6 (.535)	7,4 (.291)	3,5 (.138)	4,4 (.173)	BIT-GKS-899 M-B
T-899 305 065 400 150 A 1502 M	0,65 (.026)	4,0 (.158)	1,5 (.059)	29,9 (1.177)	14,8 (.583)	7,4 (.291)	3,5 (.138)	4,4 (.173)	BIT-GKS-899 M-B
T-899 305 070 400 150 A 1502 M	0,70 (.028)	4,0 (.158)	1,5 (.059)	29,9 (1.177)	14,8 (.583)	7,4 (.291)	3,5 (.138)	4,4 (.173)	BIT-GKS-899 M-B
T-899 305 065 270 150 A 1502 MG	0,65 (.026)	2,7 (.106)	1,5 (.059)	27,1 (1.067)	12,0 (.472)	5,9 (.232)	2,0 (.079)	2,75 (.110)	BIT-GKS-899 M-B
T-899 305 065 340 150 A 1502 MG	0,65 (.026)	3,4 (.134)	1,5 (.059)	27,8 (1.095)	12,7 (.500)	5,9 (.232)	2,0 (.079)	2,75 (.110)	BIT-GKS-899 M-B

### Ordering Example Series

Tip Materials: 3 = BeCu  
 Tip Style  
 Tip-Ø (1/100 mm) (A)  
 Tip Length (1/100 mm) (B)  
 Disk-Ø (1/100 mm) (C)  
 Plating: A = Gold  
 Spring Force (dN)  
 Collar Height (mm)  
 Special Designation alternative „MG“

Test Probe:

T 8 9 9 3 0 2 0 6 5 2 1 0 1 5 0 A 1 5 0 2 M

Receptacle for T-899 ... M:

KS - 8 9 9 3 0 M - R - T

Receptacle for Leakage Test \*\*:

KS - 8 9 9 3 0 M - R



# GKS 112 M

Screw-in Test Probe

**Grid:**

≥ 2,54 mm

≥ 100 Mil

**Installation Height:** 10,5/13,6/19,0 mm (.413/535/.748)

**Recommended Stroke:** 4,0 / 6,4 mm (.157/.252)

## Mounting and Functional Dimensions

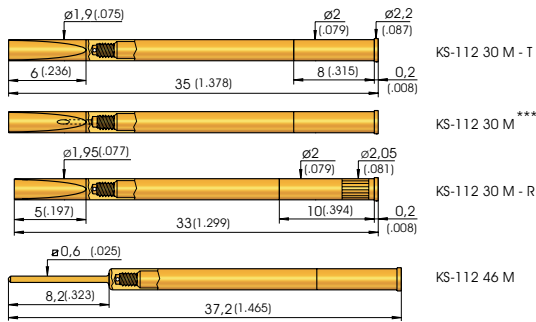
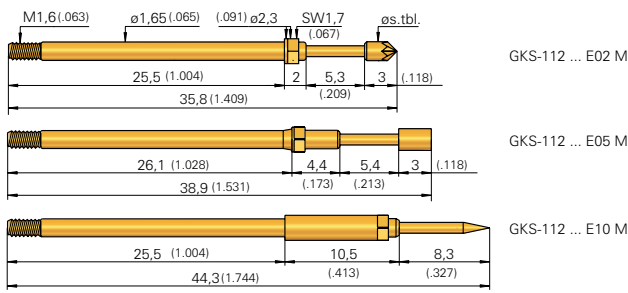

\*\*\*\* axially positioned trough-hole for leakage test. Attention: when not assembled correctly, then solder can flow inside the receptacle.

**Plug VS-112 M** is used instead of a Test Probe and prevents in case of maintenance, that not required Receptacles will accidentally be used.

VS-112 M

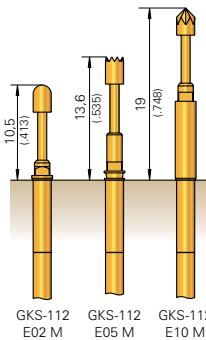
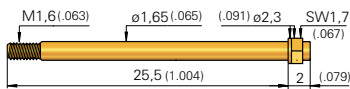

### Collar Height and Installation Height

The Installation Height of the Tip (measured with the Receptacle) is determined by the Collar Height. The Test Probe can only be used with a Receptacle.

Collar Height	Installation Height
02	10,5 mm (.413)
05	13,6 mm (.535)
10	19,0 mm (.748)

### Mechanical Data

**Working Stroke:** 4,0 mm (.157)  
**Maximum Stroke:** 5,3 mm (.209)  
**Spring Force at Work. Stroke:** 1,5 N (5.4oz)  
**alternative:** 0,6 (2.1oz); 0,8 (2.9oz); 2,25 (8.1oz); 3,0 (10.8oz); 5,0 N (18.1oz)

Test Probes with Tip Diameter ≤ 1,0 mm (.039) have a maximum Working Stroke of 8,0 mm (.315)  
 Exception: 5,0 N-Spring (18.1oz): max. Stroke is always 5,3 mm (.209)

### Electrical Data

**Current Rating:** 5 - 8 A  
**R<sub>i</sub> typical:** < 20 mΩ  
 (with Spec. Design. "MC" < 100 mΩ)

### Materials

**Plunger:** Steel or BeCu, gold-, rhodium or chemically nickel-plated  
**Barrel:** Brass, gold-plated  
**Spring:** Steel, gold-plated or Stainless Steel (MC)  
**Receptacle:** Brass, gold-plated

### Mounting Hole Size

**for KS-112 xx M and KS-112 xx M-T in CEM 1 and FR 4:** ∅ 1,99 mm (.0783)  
**for KS-112 xx M - R in CEM 1 and FR 4:** ∅ 2,00 - 2,02 mm (.0787 - .0795)

### Operating Temperature

**Standard:** -40° up to +80° C  
**with Spec. Design. „MC“:** -100° up to +200° C  
 (0,8; 1,5; 2,25; 3,0 N)

## Available Tip Styles

Material	Tip Style	Plating	Further Versions		NEW
			∅	∅ (inch)	
2	01	R A	∅ 1,00 (.039)	0,80 (.031)	
3	02 ** **	A	∅ 0,64 (.025)		NEW
3	02	A	∅ 0,64 (.025)		NEW
3	02	A	∅ 0,80 (.031)		
3	02	A	∅ 2,00 (.079)	1,00 (.039) 1,50 (.059)	
3	03	A	∅ 2,00 (.079)	1,40 (.055) 1,80 (.071)	
2	04	R	∅ 2,00 (.079)	1,30 (.051)	
3	05 **	A	∅ 0,63 (.025)		
3	05 ** **	A	∅ 0,64 (.025)		NEW
3	05	A	∅ 0,64 (.025)	0,80 (.031)	
3	05	A	∅ 2,00 (.079)	1,00 (.039) 1,40 (.055) 2,30 (.091)	
0	06*	A	∅ 1,00 (.039) ∅ 0,8 ∅ 2,30 (.091)		
3	06	A	∅ 2,00 (.079)		
3	06	R	∅ 2,00 (.079)	1,30 (.051) 1,50 (.059) 1,80 (.071) 2,50 (.098)	
2	07	R A	∅ 2,00 (.079)	1,30 A (.051)	
2	09 ***	N	∅ 0,60 (.024)		
2	14	A	∅ 1,30 (.051)	1,30 R (.051)	
2	17	N	∅ 1,75 (.069)	2,00 R (.079)	
3	19	A	∅ 1,80 (.071)	2,00 (.079)	NEW

\* also available as Tip Style 0 02 and 0 03  
 Installation Height plus 0,8 mm (.031)

\*\* Plunger with defined wobble, Spec. Designation ... MT

\*\*\* pressed-in Steel point in Base Plunger made of Brass

\*\*\*\* Tip Style with special designation "M-30"

**Note:**  
 GKS-112 ... M will be screwed into KS-112 ... M using special tools, see Page 170/171.

**Recommended Screw-in Torque:**  
 Min.: 3 Ncm / Max.: 5 Ncm

## Ordering Example

Series	Tip Material	Tip Style	Tip Diameter (1/100 mm)	Plating	Spring Force (dN)	Collar Height (mm)	Special Designation alternative "MC", "MT", "M-30" (see ****)			
G K S	1 = Delrin 2 = Steel 3 = BeCu	1 1 2	2	0 4	1 3 0	R	1 5	0 2	M	30

Test Probe:

G K S 1 1 2 2 0 4 1 3 0 R 1 5 0 2 M 30

Plug:

V S 1 1 2 M



NEW

# T-112 M / T-912 M

Screw-in Step Probes

**Grid:**  
 (dependant on max. tip-diameter) ≥ 2,54 mm  
 (dependant on max. tip-diameter) ≥ 100 Mil  
**Installation Height:** see table  
**Recommended Stroke:** 4,0 mm (.157)

## Mounting and Functional Dimensions

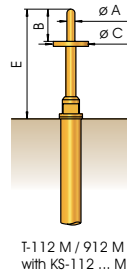
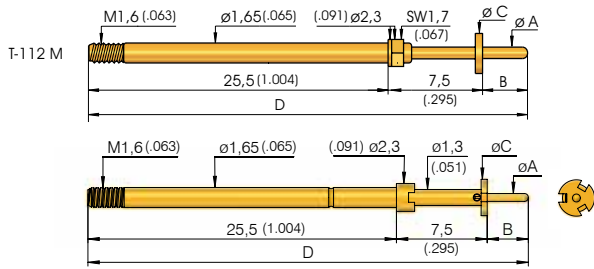

Available Tip Styles T-112 M				
Material	Tip Style	Plating	Further Versions	
			Ø	Ø (inch)
3 02		A	Ø s. Tbl.	
3 05		A	Ø s. Tbl.	
3 05 G		A	Ø s. Tbl.	

**Mechanical Data**  
**Working Stroke:** 4,0 mm (.157)  
**Maximum Stroke:** 5,0 mm (.197)  
**Spring Force at Work. Stroke:** 1,5 N (5.4oz)  
**alternative:** 0,6 N (2.1oz); 0,8 N (2.9oz);  
 2,25 N (8.1oz); 3,0 N (10.8oz);  
 5,0 N (18.1oz)

**Materials**  
**Plunger:** BeCu, gold-plated  
**Barrel:** Brass, gold-plated  
**Spring:** Steel, gold-plated  
 or Stainless Steel (MC on request)

**Note:**  
 T-112 ... M / T-112 M will be screwed into KS-112 ... M (Page 132) using special tools (see page 170/171).  
 Recommended Screw-in Torque:  
 Min.: 3 Ncm / Max.: 5 Ncm  
 \* Details of Torque Tools and Insertion Bits from page 170 on.

**Operating Temperature**  
**Standard:** -40° up to +80° C

**Electrical Data**  
**Current Rating:** 5 - 8 A  
**R<sub>i</sub> typical:** < 20 mΩ

Available Tip Styles T-912 M				
Material	Tip Style	Plating	Further Versions	
			Ø	Ø (inch)
3 02		A	Ø s. Tbl.	
3 05		A	Ø s. Tbl.	

Part No.	A Tip-Ø mm (inch)	B Tip Length mm (inch)	C Disk-Ø mm (inch)	D Total Length mm (inch)	E Install. Height with KS mm (inch)	* Tool (Insertion Bits)
T-912 302 050 150 210 A 1502 M	0,5 (.020)	1,5 (.059)	2,1 (.083)	34,5 (1.358)	9,2 (.362)	BIT-T-912 M
T-112 302 065 300 100 A 1502 M	0,65 (.026)	3,0 (.118)	1,0 (.039)	36,0 (1.417)	10,7 (.421)	BIT-GKS-112 M-B
T-912 302 070 150 210 A 1502 M	0,7 (.028)	1,5 (.059)	2,1 (.083)	34,5 (1.358)	9,2 (.362)	BIT-T-912 M
T-112 302 070 200 180 A 1502 M	0,7 (.028)	2,0 (.079)	1,8 (.071)	35,0 (1.378)	9,7 (.382)	BIT-GKS-112 M-B
T-912 302 070 200 210 A 1502 M	0,7 (.028)	2,0 (.079)	2,1 (.083)	35,0 (1.378)	9,7 (.382)	BIT-T-912 M
T-112 302 080 320 180 A 1502 M	0,8 (.031)	3,2 (.126)	1,8 (.071)	36,2 (1.425)	10,9 (.429)	BIT-GKS-112 M-B
T-912 302 080 320 210 A 1502 M	0,8 (.031)	3,2 (.126)	2,1 (.083)	36,2 (1.425)	10,9 (.429)	BIT-T-912 M
T-912 302 100 170 250 A 1502 M	1,0 (.039)	1,7 (.067)	2,5 (.098)	34,7 (1.366)	9,4 (.370)	BIT-T-912 M
T-912 302 100 180 250 A 1502 M	1,0 (.039)	1,8 (.071)	2,5 (.098)	34,8 (1.370)	9,5 (.374)	BIT-T-912 M
T-912 302 100 200 210 A 1502 M	1,0 (.039)	2,0 (.079)	2,1 (.083)	35,0 (1.378)	9,7 (.382)	BIT-T-912 M
T-912 302 100 200 250 A 1502 M	1,0 (.039)	2,0 (.079)	2,5 (.098)	35,0 (1.378)	9,7 (.382)	BIT-T-912 M
T-112 302 100 250 180 A 1502 M	1,0 (.039)	2,5 (.098)	1,8 (.071)	35,5 (1.398)	10,2 (.402)	BIT-GKS-112 M-B
T-912 302 100 250 210 A 1502 M	1,0 (.039)	2,5 (.098)	2,1 (.083)	35,5 (1.398)	10,2 (.402)	BIT-T-912 M
T-112 302 100 300 180 A 1502 M	1,0 (.039)	3,0 (.118)	1,8 (.071)	36,0 (1.417)	10,7 (.421)	BIT-GKS-112 M-B
T-912 302 100 300 210 A 1502 M	1,0 (.039)	3,0 (.118)	2,1 (.083)	36,0 (1.417)	10,7 (.421)	BIT-T-912 M
T-912 302 100 300 250 A 1502 M	1,0 (.039)	3,0 (.118)	2,5 (.098)	36,0 (1.417)	10,7 (.421)	BIT-T-912 M
T-112 302 100 320 200 A 1502 M	1,0 (.039)	3,2 (.126)	2,0 (.079)	36,2 (1.425)	10,9 (.429)	BIT-GKS-112 M-B
T-112 302 100 330 230 A 1502 M	1,0 (.039)	3,3 (.130)	2,3 (.091)	36,3 (1.429)	11,0 (.433)	BIT-GKS-112 M
T-912 302 100 330 230 A 1502 M	1,0 (.039)	3,3 (.130)	2,3 (.091)	36,3 (1.429)	11,0 (.433)	BIT-T-912 M
T-112 302 100 350 250 A 1502 M	1,0 (.039)	3,5 (.138)	2,5 (.098)	36,5 (1.437)	11,2 (.441)	BIT-GKS-112 M
T-912 302 100 350 250 A 1502 M	1,0 (.039)	3,5 (.138)	2,5 (.098)	36,5 (1.437)	11,2 (.441)	BIT-T-912 M
T-112 302 102 318 245 A 1502 M	1,02 (.039)	3,18 (.126)	2,45 (.098)	36,18 (1.425)	10,88 (.429)	BIT-GKS-112 M
T-912 302 120 120 250 A 1502 M	1,2 (.047)	1,2 (.047)	2,5 (.098)	34,2 (1.347)	8,9 (.350)	BIT-T-912 M
T-112 302 120 200 190 A 1502 M	1,2 (.047)	2,0 (.079)	1,9 (.075)	35,0 (1.378)	9,7 (.382)	BIT-GKS-112 M-B
T-912 302 120 200 210 A 1502 M	1,2 (.047)	2,0 (.079)	2,1 (.083)	35,0 (1.378)	9,7 (.392)	BIT-T-912 M
T-912 302 130 210 250 A 1502 M	1,3 (.051)	2,1 (.083)	2,5 (.098)	35,1 (1.382)	9,8 (.386)	BIT-T-912 M
T-112 302 130 300 250 A 1502 M	1,3 (.051)	3,0 (.118)	2,5 (.098)	36,0 (1.417)	10,7 (.421)	BIT-GKS-112 M
T-912 302 130 300 250 A 1502 M	1,3 (.051)	3,0 (.118)	2,5 (.098)	36,0 (1.417)	10,7 (.421)	BIT-T-912 M
T-912 302 140 160 350 A 3002 M	1,4 (.055)	1,6 (.063)	3,5 (.138)	34,6 (1.362)	9,3 (.366)	BIT-T-912 M
T-912 302 150 200 350 A 1502 M	1,5 (.059)	2,0 (.079)	3,5 (.138)	35,0 (1.378)	9,7 (.382)	BIT-T-912 M
T-112 302 150 250 300 A 1502 M	1,5 (.059)	2,5 (.098)	3,0 (.118)	35,5 (1.398)	10,2 (.402)	BIT-GKS-112 M
T-912 302 150 250 350 A 1502 M	1,5 (.059)	2,5 (.098)	3,5 (.135)	35,5 (1.398)	10,2 (.402)	BIT-T-912 M

Part No.	A Tip-Ø mm (inch)	B Tip Length mm (inch)	C Disk-Ø mm (inch)	D Total Length mm (inch)	E Install. Height with KS mm (inch)	* Tool (Insertion Bit)
T-112 305 064 150 150 A 1502 M	0,64 (.024)	1,5 (.059)	1,5 (.059)	34,5 (1.358)	9,2 (.362)	BIT-GKS-112 M-B
T-112 305 064 250 150 A 1502 M	0,64 (.024)	2,5 (.098)	1,5 (.059)	35,5 (1.398)	10,2 (.402)	BIT-GKS-112 M-B
T-112 305 064 250 180 A 1502 M	0,64 (.024)	2,5 (.098)	1,8 (.071)	35,5 (1.398)	10,2 (.402)	BIT-GKS-112 M-B
T-912 305 064 250 250 A 1502 M	0,64 (.024)	2,5 (.098)	2,5 (.098)	35,5 (1.398)	10,2 (.402)	BIT-T-912 M
T-112 305 064 300 150 A 1502 M	0,64 (.024)	3,0 (.118)	1,5 (.059)	36,0 (1.417)	10,7 (.421)	BIT-GKS-112 M-B
T-112 305 064 460 180 A 1502 M	0,64 (.024)	4,6 (.181)	1,8 (.071)	37,6 (1.480)	12,3 (.484)	BIT-GKS-112 M-B
T-112 305 065 200 180 A 3002 M	0,65 (.026)	2,0 (.079)	1,8 (.071)	35,0 (1.378)	9,7 (.382)	BIT-GKS-112 M-B
T-912 305 065 200 210 A 1502 M	0,65 (.026)	2,0 (.079)	2,1 (.083)	35 (1.378)	9,7 (.382)	BIT-T-912 M
T-912 305 065 230 250 A 1502 M	0,65 (.026)	2,3 (.091)	2,5 (.098)	35,3 (1.390)	10,0 (.394)	BIT-T-912 M
T-112 305 065 250 180 A 1502 M	0,65 (.026)	2,5 (.098)	1,8 (.071)	35,5 (1.398)	10,2 (.402)	BIT-GKS-112 M-B
T-912 305 065 250 210 A 1502 M	0,65 (.026)	2,5 (.098)	2,1 (.083)	35,5 (1.398)	10,2 (.402)	BIT-T-912 M
T-112 305 065 270 150 A 1502 M	0,65 (.026)	2,7 (.106)	1,5 (.059)	35,7 (1.406)	10,4 (.409)	BIT-GKS-112 M-B
T-112 305 065 270 150 A 1502 MG	0,65 (.026)	2,7 (.106)	1,5 (.059)	35,7 (1.406)	10,4 (.409)	BIT-GKS-112 M-B
T-912 305 065 300 210 A 1502 M	0,65 (.026)	3,0 (.118)	2,1 (.083)	36,0 (1.417)	10,7 (.421)	BIT-T-912 M
T-112 305 065 340 180 A 1502 M	0,65 (.026)	3,4 (.134)	1,8 (.071)	36,4 (1.433)	11,1 (.437)	BIT-GKS-112 M-B
T-912 305 065 340 210 A 1502 M	0,65 (.026)	3,4 (.134)	2,1 (.083)	36,4 (1.433)	11,1 (.437)	BIT-T-912 M
T-112 305 065 340 300 A 1502 M	0,65 (.026)	3,4 (.134)	3,0 (.118)	36,4 (1.433)	11,1 (.437)	BIT-GKS -112 M
T-912 305 065 340 300 A 1502 M	0,65 (.026)	3,4 (.134)	3,0 (.118)	36,4 (1.433)	11,1 (.437)	BIT-T-912 M
T-112 305 065 360 180 A 1502 M	0,65 (.026)	3,6 (.142)	1,8 (.071)	36,6 (1.457)	11,3 (.445)	BIT-GKS-112 M-B
T-912 305 065 360 210 A 1502 M	0,65 (.026)	3,6 (.142)	2,1 (.083)	36,6 (1.457)	11,3 (.445)	BIT-T-912 M
T-112 305 065 430 150 A 1502 M	0,65 (.026)	4,3 (.169)	1,5 (.059)	37,3 (1.479)	12,0 (.472)	BIT-GKS-112 M-B
T-112 305 065 500 150 A 1502 M	0,65 (.026)	5,0 (.197)	1,5 (.059)	38,0 (1.496)	12,7 (.500)	BIT-GKS-112 M-B
T-912 305 080 200 250 A 1502 M	0,8 (.032)	2,0 (.079)	2,5 (.098)	35,0 (1.378)	9,7 (.382)	BIT-T-912 M
T-912 305 080 230 250 A 1502 M	0,8 (.032)	2,3 (.091)	2,5 (.098)	35,3 (1.390)	10,0 (.394)	BIT-T-912 M
T-112 305 080 280 180 A 1502 M	0,8 (.032)	2,8 (.110)	1,8 (.071)	35,8 (1.409)	10,5 (.413)	BIT-GKS-112 M-B
T-112 305 080 280 195 A 1502 M	0,8 (.032)	2,8 (.110)	1,95 (.079)	35,8 (1.409)	10,5 (.413)	BIT-GKS-112 M-B
T-912 305 080 280 210 A 1502 M	0,8 (.032)	2,8 (.110)	2,1 (.083)	35,8 (1.409)	10,5 (.413)	BIT-T-912 M
T-112 305 080 280 250 A 1502 M	0,8 (.032)	2,8 (.110)	2,5 (.098)	35,8 (1.409)	10,5 (.413)	BIT-GKS-112 M
T-912 305 080 280 250 A 1502 M	0,8 (.032)	2,8 (.110)	2,5 (.098)	35,8 (1.409)	10,5 (.413)	BIT-T-912 M
T-112 305 080 320 230 A 1502 M	0,8 (.032)	3,2 (.126)	2,3 (.091)	36,2 (1.425)	10,9 (.429)	BIT-GKS-112 M
T-912 305 080 320 230 A 1502 M	0,8 (.032)	3,2 (.126)	2,3 (.091)	36,2 (1.425)	10,9 (.429)	BIT-T-912 M
T-112 305 080 320 350 A 1502 M	0,8 (.032)	3,2 (.126)	3,5 (.138)	36,2 (1.425)	10,9 (.429)	BIT-GKS-112 M
T-912 305 080 320 350 A 1502 M	0,8 (.032)	3,2 (.126)	3,5 (.138)	36,2 (1.425)	10,9 (.429)	BIT-T-912 M
T-112 305 080 400 180 A 1502 M	0,8 (.032)	4,0 (.158)	1,8 (.071)	37,0 (1.457)	11,7 (.461)	BIT-GKS-112 M-B
T-912 305 080 400 210 A 1502 M	0,8 (.032)	4,0 (.158)	2,1 (.083)	37,0 (1.457)	11,7 (.461)	BIT-T-912 M
T-112 305 080 400 250 A 1502 M	0,8 (.032)	4,0 (.158)	2,5 (.098)	37,0 (1.457)	11,7 (.461)	BIT-GKS-112 M
T-912 305 080 400 250 A 1502 M	0,8 (.032)	4,0 (.158)	2,5 (.098)	37,0 (1.457)	11,7 (.461)	BIT-T-912 M
T-112 305 080 460 250 A 1502 M	0,8 (.032)	4,6 (.181)	2,5 (.098)	37,6 (1.480)	12,3 (.484)	BIT-GKS-112 M
T-912 305 080 460 250 A 1502 M	0,8 (.032)	4,6 (.181)	2,5 (.098)	37,6 (1.480)	12,3 (.484)	BIT-T-912 M
T-912 305 080 530 280 A 1502 M	0,8 (.032)	5,3 (.209)	2,8 (.110)	38,3 (1.508)	13,0 (.512)	BIT-T-912 M
T-112 305 100 200 180 A 1502 M	1,0 (.039)	2,0 (.079)	1,8 (.071)	35,0 (1.378)	9,7 (.382)	BIT-GKS-112 M-B
T-912 305 100 200 210 A 1502 M	1,0 (.039)	2,0 (.079)	2,1 (.083)	35,0 (1.378)	9,7 (.382)	BIT-T-912 M
T-912 305 100 250 300 A 1502 M	1,0 (.039)	2,5 (.098)	3,0 (.118)	35,5 (1.398)	10,2 (.402)	BIT-T-912 M
T-912 305 100 260 210 A 1502 M	1,0 (.039)	2,6 (.102)	2,1 (.083)	35,6 (1.402)	10,3 (.406)	BIT-T-912 M
T-912 305 100 260 230 A 1502 M	1,0 (.039)	2,6 (.102)	2,3 (.091)	35,6 (1.402)	10,3 (.406)	BIT-T-912 M
T-112 305 100 260 250 A 1502 M	1,0 (.039)	2,6 (.102)	2,5 (.098)	35,6 (1.402)	10,3 (.406)	BIT-GKS-112 M
T-912 305 100 260 250 A 1502 M	1,0 (.039)	2,6 (.102)	2,5 (.098)	35,6 (1.402)	10,3 (.406)	BIT-T-912 M
T-912 305 100 350 250 A 1502 M	1,0 (.039)	3,5 (.138)	2,5 (.098)	36,5 (1.402)	11,2 (.441)	BIT-T-912 M
T-112 305 100 420 180 A 1502 M	1,0 (.039)	4,2 (.165)	1,8 (.071)	37,2 (1.465)	11,9 (.496)	BIT-GKS-112 M-B
T-912 305 100 420 210 A 1502 M	1,0 (.039)	4,2 (.165)	2,1 (.083)	37,2 (1.465)	11,9 (.496)	BIT-T-912 M
T-112 305 100 490 180 A 1502 M	1,0 (.039)	4,9 (.193)	1,8 (.071)	37,9 (1.492)	12,6 (.496)	BIT-GKS-112 M-B
T-912 305 100 490 210 A 1502 M	1,0 (.039)	4,9 (.193)	2,1 (.083)	37,9 (1.492)	12,6 (.496)	BIT-T-912 M
T-912 305 100 600 250 A 1502 M	1,0 (.039)	6,0 (.236)	2,5 (.098)	39,0 (1.535)	13,7 (.539)	BIT-T-912 M
T-912 305 120 220 250 A 3002 M	1,2 (.047)	2,2 (.087)	2,5 (.098)	35,2 (1.386)	9,9 (.390)	BIT-T-912 M
T-912 305 120 250 250A 1502 M	1,2 (.047)	2,5 (.098)	2,5 (.098)	35,5 (1.398)	10,2 (.402)	BIT-T-912 M
T-912 305 140 160 320 A 1502 M	1,4 (.055)	1,6 (.063)	3,2 (.126)	34,6 (1.362)	9,3 (.366)	BIT-T-912 M
T-912 305 140 350 250 A 3002 M	1,4 (.055)	3,5 (.138)	2,5 (.098)	36,5 (1.437)	11,2 (.441)	BIT-T-912 M
T-912 305 140 350 280 A 3002 M	1,4 (.055)	3,5 (.138)	2,8 (.110)	36,5 (1.437)	11,2 (.441)	BIT-T-912 M
T-912 305 150 250 300 A 1502 M	1,5 (.059)	2,5 (.098)	3,0 (.118)	35,5 (1.398)	10,2 (.402)	BIT-T-912 M

**Grid:**  
 ≥ 4,0 mm  
 ≥ 160 Mil

**Installation Height:** 10,5 mm (.413)  
**Recommended Stroke:** 4,0 mm (.157)

## Mounting and Functional Dimensions

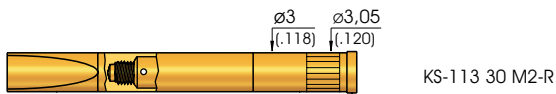
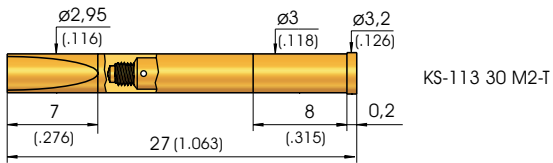
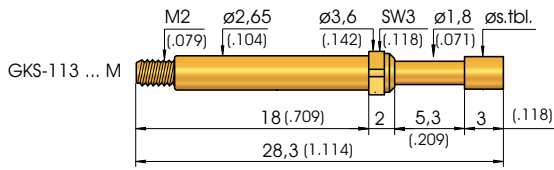

\*\*\* axially positioned trough-hole for leakage test. Attention: when not assembled correctly, then solder can flow inside the receptacle.

### Collar Height and Installation Height

The Installation Height of the Tip is always 10,5 mm (.413). The Test Probe can only be used with a Receptacle.

### Mechanical Data

**Working Stroke:** 4,0 mm (.157)  
**Maximum Stroke:** 5,3 mm (.209)  
**Spring Force at Work. Stroke:** 1,5 N (5.4oz)  
**alternative:** 0,3 N (1.1oz); 0,6 N (2.2oz); 1,0 N (3.6oz); 2,25 (8.1oz); 3,0 N (10.8oz); 5,0 N (18.1oz)

### Electrical Data

**Current Rating:** 5 - 8 A  
**R<sub>i</sub> typical:** ≤ 30 mΩ  
 (\*\* < 100 mΩ)

### Operating Temperature

**Standard:** -40° up to +80° C  
**\*\*with Spec. Design. „MC“:** -100° up to +200° C  
 (1,5 N; 2,25 N; 3,0 N)

### Materials

**Plunger:** Steel or BeCu, gold-, rhodium or chemically nickel-plated  
**Barrel:** Brass, gold-plated  
**Spring:** Steel, gold-plated or Stainless Steel\*\* (MC)  
**Receptacle:** Brass, gold-plated

### Mounting Hole Size

**for KS-113 30 M2 and KS-113 30 M2-T in CEM 1 and FR 4:** ∅ 2,99 mm (.1177)  
**for KS-113 30 M2- R in CEM 1 and FR 4:** ∅ 3,00 - 3,02 mm (.1181 - .1189)

**Note:**  
 GKS-113 ... M will be screwed into KS-113 ... M using special tools, see Page 170/171.

**Recommended Screw-in Torque:**  
 Min.: 10 Ncm / Max.: 20 Ncm

## Available Tip Styles

Material	Tip Style	Plating	Further Versions	
			∅	∅ (inch)
2 01		R		
3 02		A	0,80 (.031) 1,00 (.039) 1,80 (.071) 3,00 (.118) 4,00 (.157)	
2 03		A		
3 03		A	4,00 R	(.157)
2 04		R	1,80 A 3,00	(.071) (.118)
3 05		A	0,80 (.031) 1,40 (.055) 3,00 R	(.118)
3 55		R		
Tip Length 4 mm (.157)				
3 06		A	1,60 (.063) 2,30 (.091) 4,00 (.157) 8,00 (.315)	
3 06		R	2,50 (.098) 3,50 (.138) 6,00 (.236)	
2 07		A		
3 07		R		
3 12		A		
3 13		R		
2 14		R		
2 15*		A		
2 17		R	1,80 (.071) 3,00 A	(.118)
3 19		A	3,00	(.118)
3 72		A		
2 87		N	4,00	(.157)
2 88		A		

\* pressed-in Steel Tip in Base Plunger made of Brass

## Ordering Example

Series	Tip Material	Tip Style	Tip Diameter (1/100 mm)	Plating	Spring Force (dN)	Collar Height (mm)	Special Designation alternative „MC“
	2 = Steel 3 = BeCu			A = Gold N = Nickel R = Rhodium			

Test Probe:

G K S 1 1 3 3 0 6 2 3 0 R 1 5 0 2 M

Receptacles for GKS-113 ... M:

K S - 1 1 3 3 0 M 2 - R    K S - 1 1 3 3 0 M 2 - T

Receptacles for Leakage Test\*\*\*:

K S - 1 1 3 3 0 M 2

# T-113 M / T-888 M

Screw-in Step Probes

**NEW**

**Grid:**

≥ 4,00 mm (dependant on max. tip-diameter)

≥ 160 Mil (dependant on max. tip-diameter)

**Installation Height:** see table

**Recommended Stroke:** 4,0 mm (.157)

## Mounting and Functional Dimensions

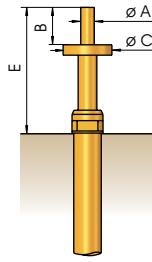
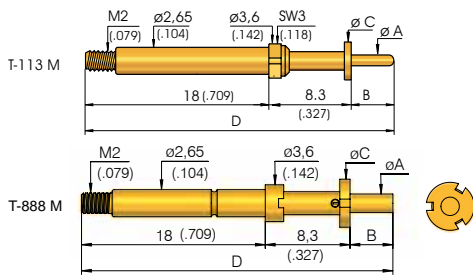

T-113 / T-888 M  
with KS 113 ... M

**Mechanical Data**

- Working Stroke:** 4,0 mm (.158)
- Maximum Stroke:** 5,0 mm (.197)
- Spring Forces at Work. Str.:** 1,5 N (5,4oz)
- altern. T-113 M:** 0,3 N (1.1oz); 0,6 N (2.2oz); 1,0 N (3.6 oz); 2,25 N (8.1oz); 3,0 N (10.8oz); 5,0 N (18.1oz)
- altern. T-888 M:** 3,0 N (10.8oz)

**Electrical Data**

- Current Rating:** 5 - 8 A
- R<sub>i</sub> typical:** < 30 mΩ

**Operating Temperature**

**Standard:** -40° up to +80° C

**Materials**

- Plunger:** BeCu, gold-plated
- Barrel:** Brass, gold-plated
- Spring:** Steel, gold-plated or Stainless Steel (MC on request)

**Note:**

T-113 ... M / T-888 M will be screwed into KS-113 ... M (Page 135) using special tools (see Page 170/171).  
Recommended Screw-in Torque:  
Min.: 10 Ncm / Max.: 20 Ncm  
\*\*\* Details of Torque Tools and Insertion Bits from page 170 on.

### Available Tip Style T-113 M

Material	Tip Style	Plating	Further Versions	
			∅	∅ (inch)
3 02	∅ s. Tbl.	A		
3 05	∅ s. Tbl.	A		

### Available Tip Style T-888 M

Material	Tip Style	Plating	Further Versions	
			∅	∅ (inch)
3 02*	∅ s. Tbl.	A		
3 02	∅ s. Tbl.	A		
3 05**	∅ s. Tbl.	A		

\* ∅ A ≤ 2,5 mm

\*\* ∅ A ≥ 3,5 mm (screw-in only with Tool BIT-T-912 M)

Part No.	A Tip-∅ mm (inch)	B Tip Length mm (inch)	C Disk-∅ mm (inch)	D Total Length mm (inch)	E Install. Height with KS mm (inch)	*** Tool (Insertion Bit)
T-113 302 100 300 350 A 1502 M	1,0 (.039)	3,0 (.118)	3,5 (.138)	29,3 (1.154)	11,5 (.453)	BIT-GKS-113 M
T-888 302 100 300 350 A 1502 M	1,0 (.039)	3,0 (.118)	3,5 (.138)	29,3 (1.154)	11,5 (.453)	BIT-T-888 M-3
T-113 302 130 270 470 A 1502 M	1,3 (.051)	2,7 (.106)	4,7 (.185)	29,0 (1.142)	11,2 (.441)	BIT-T-113 M
T-888 302 130 270 470 A 1502 M	1,3 (.051)	2,7 (.106)	4,7 (.185)	29,0 (1.142)	11,2 (.441)	BIT-T-888 M
T-888 302 130 300 470 A 1502 M	1,3 (.051)	3,0 (.118)	4,7 (.185)	29,3 (1.154)	11,5 (.453)	BIT-T-888 M
T-113 302 130 360 470 A 1502 M	1,3 (.051)	3,6 (.142)	4,7 (.185)	29,9 (1.177)	12,1 (.476)	BIT-T-113 M
T-888 302 130 360 470 A 1502 M	1,3 (.051)	3,6 (.142)	4,7 (.185)	29,9 (1.177)	12,1 (.476)	BIT-T-888 M
T-113 302 130 530 470 A 1502 M	1,3 (.051)	5,3 (.209)	4,7 (.185)	31,6 (1.244)	13,8 (.543)	BIT-T-113 M
T-888 302 130 530 470 A 1502 M	1,3 (.051)	5,3 (.209)	4,7 (.185)	31,5 (1.240)	13,7 (.539)	BIT-T-888 M
T-113 302 130 580 470 A 1502 M	1,3 (.051)	5,8 (.228)	4,7 (.185)	32,1 (1.264)	14,3 (.563)	BIT-T-113 M
T-888 302 130 580 470 A 1502 M	1,3 (.051)	5,8 (.228)	4,7 (.185)	32,0 (1.260)	14,2 (.559)	BIT-T-888 M
T-113 302 140 100 350 A 1502 M	1,4 (.055)	1,0 (.039)	3,5 (.138)	27,3 (1.074)	9,5 (.374)	BIT-GKS-113 M
T-888 302 140 100 350 A 1502 M	1,4 (.055)	1,0 (.039)	3,5 (.138)	27,3 (1.074)	9,5 (.374)	BIT-T-888 M
T-113 302 140 170 350 A 1502 M	1,4 (.055)	1,7 (.067)	3,5 (.138)	28,0 (1.102)	10,2 (.402)	BIT-GKS-113 M
T-888 302 140 170 350 A 1502 M	1,4 (.055)	1,7 (.067)	3,5 (.138)	28,0 (1.102)	10,2 (.402)	BIT-T-888 M
T-113 302 140 200 350 A 1502 M	1,4 (.055)	2,0 (.079)	3,5 (.138)	28,3 (1.114)	10,5 (.413)	BIT-GKS-113 M
T-888 302 140 200 350 A 1502 M	1,4 (.055)	2,0 (.079)	3,5 (.138)	28,3 (1.114)	10,5 (.413)	BIT-T-888 M-3
T-113 302 140 240 350 A 1502 M	1,4 (.055)	2,4 (.095)	3,5 (.138)	28,7 (1.130)	10,9 (.429)	BIT-GKS-113 M
T-888 302 140 240 350 A 1502 M	1,4 (.055)	2,4 (.095)	3,5 (.138)	28,7 (1.130)	10,9 (.429)	BIT-T-888 M
T-113 302 140 300 350 A 1502 M	1,4 (.055)	3,0 (.118)	3,5 (.138)	29,3 (1.154)	11,5 (.453)	BIT-GKS-113 M
T-888 302 140 300 350 A 1502 M	1,4 (.055)	3,0 (.118)	3,5 (.138)	29,3 (1.154)	11,5 (.453)	BIT-T-888 M
T-113 302 140 320 250 A 1502 M	1,4 (.055)	3,2 (.126)	2,5 (.098)	29,5 (1.161)	11,7 (.461)	BIT-GKS-113 M-B
T-113 302 170 220 300 A 1502 M	1,7 (.067)	2,2 (.087)	3,0 (.118)	28,5 (1.122)	10,7 (.421)	BIT-GKS-113 M-B
T-113 302 170 220 350 A 1502 M	1,7 (.067)	2,2 (.087)	3,5 (.138)	28,5 (1.122)	10,7 (.421)	BIT-GKS-113 M
T-888 302 170 220 350 A 1502 M	1,7 (.067)	2,2 (.087)	3,5 (.138)	28,5 (1.122)	10,7 (.421)	BIT-T-888 M
T-888 302 180 140 450 A 1502 M	1,8 (.071)	1,4 (.055)	4,5 (.177)	27,7 (1.091)	9,9 (.390)	BIT-T-888 M
T-113 302 180 150 450 A 1502 M	1,8 (.071)	1,5 (.059)	4,5 (.177)	27,8 (1.095)	10,0 (.394)	BIT-T-113 M
T-888 302 180 150 450 A 1502 M	1,8 (.071)	1,5 (.059)	4,5 (.177)	27,8 (1.095)	10,0 (.394)	BIT-T-888 M
T-113 302 180 160 350 A 1502 M	1,8 (.071)	1,6 (.063)	3,5 (.138)	27,9 (1.098)	10,1 (.398)	BIT-GKS-113 M
T-888 302 180 160 350 A 1502 M	1,8 (.071)	1,6 (.063)	3,5 (.138)	27,9 (1.098)	10,1 (.398)	BIT-T-888 M-3
T-888 302 180 200 470 A 1502 M	1,8 (.071)	2,0 (.079)	4,7 (.185)	28,3 (1.114)	10,5 (.413)	BIT-T-888 M
T-888 302 180 220 350 A 1502 M	1,8 (.071)	2,2 (.087)	3,5 (.138)	28,5 (1.122)	10,7 (.421)	BIT-T-888 M-3

Part No.	A Tip-Ø mm (inch)	B Tip Length mm (inch)	C Disk-Ø mm (inch)	D Total Length mm (inch)	E Install. Height with KS mm (inch)	*** Tool (Insertion Bit)
T-888 302 180 420 470 A 1502 M	1,8 (.071)	4,2 (.165)	4,7 (.185)	30,5 (1.201)	12,7 (.500)	BIT-T-888 M
T-888 302 180 500 470 A 1502 M	1,8 (.071)	5,0 (.197)	4,7 (.185)	31,3 (1.232)	13,5 (.532)	BIT-T-888 M
T-113 302 180 580 470 A 1502 M	1,8 (.071)	5,8 (.228)	4,7 (.185)	32,1 (1.264)	14,3 (.563)	BIT-T-113 M
T-888 302 180 580 470 A 1502 M	1,8 (.071)	5,8 (.228)	4,7 (.185)	32,1 (1.264)	14,3 (.563)	BIT-T-888 M
T-888 302 220 180 350 A 1502 M	2,2 (.087)	1,8 (.071)	3,5 (.138)	28,1 (1.106)	10,3 (.406)	BIT-T-888 M-3
T-888 302 220 200 350 A 1502 M	2,2 (.087)	2,0 (.079)	3,5 (.138)	28,3 (1.114)	10,5 (.413)	BIT-T-888 M-3
T-113 302 230 180 350 A 1502 M	2,3 (.091)	1,8 (.071)	3,5 (.138)	28,1 (1.106)	10,3 (.406)	BIT-GKS-113 M
T-113 302 230 200 350 A 1502 M	2,3 (.091)	2,0 (.079)	3,5 (.138)	28,3 (1.114)	10,5 (.413)	BIT-GKS-113 M
T-888 302 250 120 470 A 1502 M	2,5 (.098)	1,2 (.048)	4,7 (.185)	27,5 (1.083)	9,7 (.382)	BIT-T-888 M
T-888 302 250 200 470 A 1502 M	2,5 (.098)	2,0 (.079)	4,7 (.185)	28,3 (1.114)	10,5 (.413)	BIT-T-888 M
T-888 302 250 220 470 A 1502 M	2,5 (.098)	2,2 (.087)	4,7 (.185)	28,5 (1.122)	10,7 (.421)	BIT-T-888 M
T-888 302 250 300 470 A 1502 M	2,5 (.098)	3,0 (.118)	4,7 (.185)	29,3 (1.154)	11,5 (.453)	BIT-T-888 M
T-888 302 370 350 500 A 1502 M	3,7 (.146)	3,5 (.138)	5,0 (.197)	29,8 (1.173)	12,0 (.472)	BIT-T-912 M
T-888 302 370 550 500 A 1502 M	3,7 (.146)	5,5 (.217)	5,0 (.197)	31,8 (1.252)	14,0 (.551)	BIT-T-912 M
T-888 302 400 100 500 A 1502 M	4,0 (.158)	1,0 (.039)	5,0 (.197)	27,3 (1.075)	9,5 (.374)	BIT-T-912 M
T-888 302 400 130 500 A 1502 M	4,0 (.158)	1,3 (.051)	5,0 (.197)	27,6 (1.087)	9,8 (.386)	BIT-T-912 M
T-888 302 400 170 500 A 1502 M	4,0 (.158)	1,7 (.067)	5,0 (.197)	28,0 (1.102)	10,2 (.402)	BIT-T-912 M
T-113 302 400 200 500 A 1502 M	4,0 (.158)	2,0 (.079)	5,0 (.197)	28,3 (1.114)	10,5 (.413)	BIT-T-113 M
T-888 302 400 200 500 A 1502 M	4,0 (.158)	2,0 (.079)	5,0 (.197)	28,3 (1.114)	10,5 (.413)	BIT-T-912 M
T-113 305 080 150 300 A 1502 M	0,8 (.032)	1,5 (.059)	3,0 (.118)	27,8 (1.095)	10,0 (.394)	BIT-GKS-113 M-B
T-888 305 080 150 300 A 1502 M	0,8 (.032)	1,5 (.059)	3,0 (.118)	27,8 (1.095)	10,0 (.394)	BIT-T-888 M-3
T-113 305 080 250 300 A 1502 M	0,8 (.032)	2,5 (.098)	3,0 (.118)	28,8 (1.134)	11,0 (.433)	BIT-GKS-113 M-B
T-888 305 080 250 300 A 1502 M	0,8 (.032)	2,5 (.098)	3,0 (.118)	28,8 (1.134)	11,0 (.433)	BIT-T-888 M-3
T-113 305 080 280 300 A 1502 M	0,8 (.032)	2,8 (.110)	3,0 (.118)	29,1 (1.146)	11,3 (.445)	BIT-GKS-113 M-B
T-888 305 080 280 300 A 1502 M	0,8 (.032)	2,8 (.110)	3,0 (.118)	29,1 (1.146)	11,3 (.445)	BIT-T-888 M-3
T-113 305 080 300 300 A 1502 M	0,8 (.032)	3,0 (.118)	3,0 (.118)	29,3 (1.154)	11,5 (.445)	BIT-GKS-113 M-B
T-888 305 080 300 300 A 1502 M	0,8 (.032)	3,0 (.118)	3,0 (.118)	29,3 (1.154)	11,5 (.445)	BIT-T-888 M-3
T-113 305 100 280 350 A 1502 M	1,0 (.039)	2,8 (.110)	3,5 (.138)	29,1 (1.146)	11,3 (.445)	BIT-GKS-113 M
T-888 305 100 280 350 A 1502 M	1,0 (.039)	2,8 (.110)	3,5 (.138)	29,1 (1.146)	11,3 (.445)	BIT-T-888 M-3
T-113 305 100 400 350 A 1502 M	1,0 (.039)	4,0 (.158)	3,5 (.138)	30,3 (1.193)	12,5 (.492)	BIT-GKS-113 M
T-888 305 100 400 350 A 1502 M	1,0 (.039)	4,0 (.158)	3,5 (.138)	30,3 (1.193)	12,5 (.492)	BIT-T-888 M-3
T-113 305 140 100 350 A 1502 M	1,4 (.055)	1,0 (.039)	3,5 (.138)	27,3 (1.075)	9,5 (.374)	BIT-GKS-113 M
T-888 305 140 100 350 A 1502 M	1,4 (.055)	1,0 (.039)	3,5 (.138)	27,3 (1.075)	9,5 (.374)	BIT-T-888 M-3
T-113 305 140 170 320 A 1502 M	1,4 (.055)	1,7 (.067)	3,2 (.126)	28,0 (1.102)	10,2 (.402)	BIT-GKS-113 M
T-888 305 140 170 320 A 1502 M	1,4 (.055)	1,7 (.067)	3,2 (.126)	28,0 (1.102)	10,2 (.402)	BIT-T-888 M-3
T-888 305 140 200 350 A 1502 M	1,4 (.055)	2,0 (.079)	3,5 (.138)	28,3 (1.114)	10,5 (.413)	BIT-T-888 M-3
T-113 305 140 240 350 A 1502 M	1,4 (.055)	2,4 (.095)	3,5 (.138)	28,7 (1.130)	10,9 (.429)	BIT-GKS-113 M
T-888 305 140 240 350 A 1502 M	1,4 (.055)	2,4 (.095)	3,5 (.138)	28,7 (1.130)	10,9 (.429)	BIT-T-888 M-3
T-888 305 140 270 350 A 1502 M	1,4 (.055)	2,7 (.106)	3,5 (.138)	29,0 (1.142)	11,2 (.441)	BIT-T-888 M-3
T-113 305 140 320 350 A 1502 M	1,4 (.055)	3,2 (.126)	3,5 (.138)	29,5 (1.161)	10,7 (.421)	BIT-GKS-113 M
T-888 305 140 320 350 A 1502 M	1,4 (.055)	3,2 (.126)	3,5 (.138)	29,5 (1.161)	11,7 (.461)	BIT-T-888 M-3
T-113 305 140 330 350 A 1502 M	1,4 (.055)	3,3 (.130)	3,5 (.138)	29,6 (1.165)	11,8 (.465)	BIT-GKS-113 M
T-888 305 140 330 350 A 1502 M	1,4 (.055)	3,3 (.130)	3,5 (.138)	29,6 (1.165)	11,8 (.465)	BIT-T-888 M-3
T-113 305 140 400 350 A 1502 M	1,4 (.055)	4,0 (.158)	3,5 (.138)	30,3 (1.193)	12,5 (.492)	BIT-GKS-113 M
T-888 305 140 400 350 A 1502 M	1,4 (.055)	4,0 (.158)	3,5 (.138)	30,3 (1.193)	12,5 (.492)	BIT-T-888 M-3
T-113 305 150 400 350 A 1502 M	1,5 (.059)	4,0 (.158)	3,5 (.138)	30,3 (1.193)	12,5 (.492)	BIT-GKS-113 M
T-888 305 150 400 350 A 1502 M	1,5 (.059)	4,0 (.158)	3,5 (.138)	30,3 (1.193)	12,5 (.492)	BIT-T-888 M-3
T-113 305 170 220 330 A 1502 M	1,7 (.067)	2,2 (.087)	3,3 (.130)	28,5 (1.120)	10,7 (.421)	BIT-GKS-113 M
T-888 305 170 220 330 A 1502 M	1,7 (.067)	2,2 (.087)	3,3 (.130)	28,5 (1.120)	10,7 (.421)	BIT-T-888 M-3
T-113 305 180 140 400 A 1502 M	1,8 (.071)	1,4 (.055)	4,0 (.158)	27,7 (1.091)	9,9 (.390)	BIT-GKS-113 M
T-888 305 180 140 400 A 1502 M	1,8 (.071)	1,4 (.055)	4,0 (.158)	27,7 (1.091)	9,9 (.390)	BIT-T-888 M-3
T-113 305 180 300 400 A 1502 M	1,8 (.071)	3,0 (.118)	4,0 (.158)	29,3 (1.154)	11,5 (.453)	BIT-GKS-113 M
T-888 305 180 300 400 A 1502 M	1,8 (.071)	3,0 (.118)	4,0 (.158)	29,3 (1.154)	11,5 (.453)	BIT-T-888 M-3



# GKS 854 / 854 M

Screw-in Test Probe

**Grid:**

≥ 5,08 mm

≥ 200 Mil

**Installation Height:** 10,8 mm (.425)

**Recommended Stroke:** 4,0 mm (.157)

## Mounting and Functional Dimensions

### GKS-854 ... M

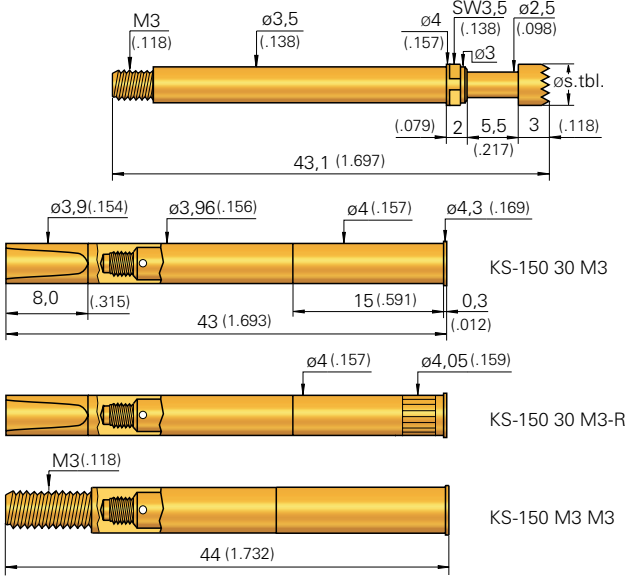

### GKS-854

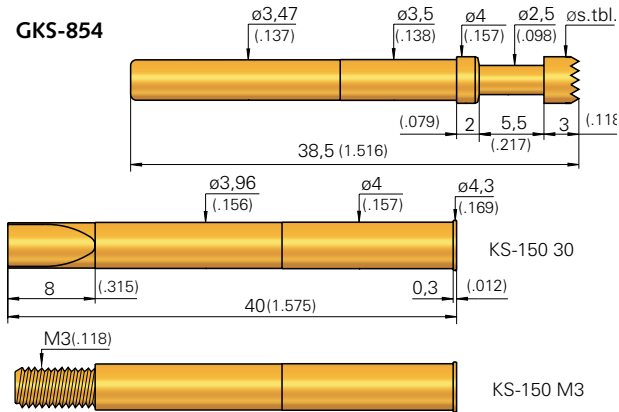

#### Mechanical Data

**Working Stroke:** 4,4 mm (.173)  
**Maximum Stroke:** 5,5 mm (.217)  
**Spring Forces at Work. Str. alternative:** 3,0 N (10.8oz) / 5,0 N (18.1oz)

#### Electrical Data

**Current Rating:** 10 - 12 A  
**R<sub>i</sub> typical:** < 20 mΩ (\*\* < 100 mΩ)

#### Operating Temperature

**Standard:** -40° up to +80° C  
**\*\*with Spec. Design. „C“:** -100° up to +200° C (1,5; 5,0 N)

#### Materials

**Plunger:** BeCu, gold-plated  
**Barrel:** Brass, gold-plated  
**Spring:** Steel, gold-plated or Stainless Steel \*\* (C)  
**Receptacle:** Brass, gold-plated

#### Mounting Hole Size

**for KS-150 30 M3 and KS-150 M3 M3 in CEM 1 and FR 4:** ø 3,99 mm (.1571)  
**for KS-150 30 M3-R in CEM 1 and FR 4:** ø 4,00 - 4,02 mm (.1575 - .1583)  
**for KS-150 30 and KS-150 M3 in CEM 1 and FR 4:** ø 3,98 - 3,99 mm (.1567 - .1571)

## Available Tip Styles

Material	Tip Style	Plating	Further Versions	
			ø	ø (inch)
3 19		A	ø 4,00 (.157)	
3 06		A	ø 4,00 (.157)	

#### Collar Height and Installation Height

The Installation Height of the Tip (measured with the Receptacle) is determined by the Collar Height. The Test Probe can only be used with a Receptacle.

Collar Height	Installation Height (with Receptacle)
02	10,8 mm

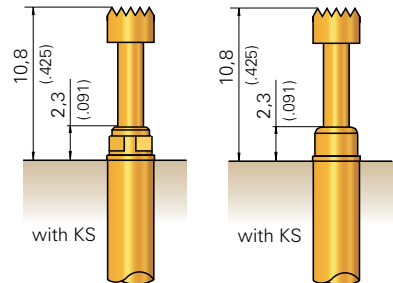

#### Note:

GKS-854 will be screwed into KS-150 ... M using special tools (see Page 170/171).

Recommended Screw-in Torque: Min.: 10 Ncm / Max.: 20 Ncm

## Ordering Example

Series	Tip Material	Tip Style	Tip Diameter (1/100 mm)	Plating	Spring Force (dN)	Collar Height (mm)	Special Designation „C“, „M“, „MC“
	3 = BeCu			A = Gold			

Test Probe:

G K S 8 5 4 3 1 9 4 0 0 A 3 0 0 2

Receptacles for GKS-854 ... M:

K S - 1 5 0 3 0 M 3 K S - 1 5 0 3 0 M 3 - R K S - 1 5 0 M 3 M 3

Receptacles for GKS-854:

K S - 1 5 0 3 0 K S - 1 5 0 M 3



**Grid:**  
 ≥ 4,50 mm  
 ≥ 177 Mil

**Installation Height:** 13,0 mm (.512)  
**Recommended Stroke:** 5,6 mm (.220)

### Mounting and Functional Dimensions

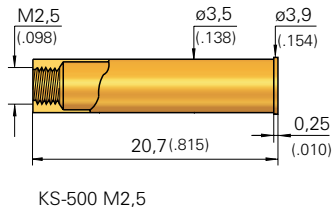
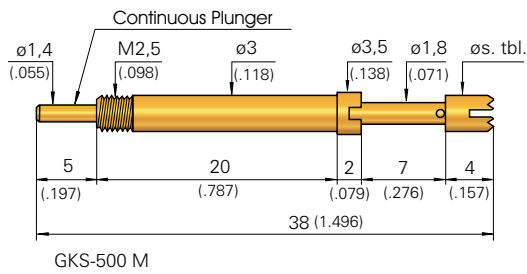

### Available Tip Styles

Material	Tip Style	Plating	Further Versions	
			∅	∅ (inch)
3	06	A	∅ 3,00 (.118)	
3	06	A	∅ 4,00 (.157)	

#### Collar Height and Installation Height

The Installation Height of the Tip is always 13,0 mm (.512). The Test Probe can only be used with a Receptacle.

Collar Height	Installation Height
02	13,0 mm (.512)

#### Mechanical Data

**Working Stroke:** 5,6 mm (.220)  
**Maximum Stroke:** 7,0 mm (.276)  
**Spring Force at Work. Stroke:** 1,5 N (5.4oz)  
**alternative:** 3,0 N (10.8oz); 5,0 N (18.1oz)

#### Materials

**Plunger:** BeCu, gold-plated  
**Barrel:** Brass, gold-plated  
**Spring:** Steel, gold-plated  
**Receptacle:** Brass, gold-plated

#### Electrical Data

**Current Rating**  
**Connection to Plunger:** 12 - 15 A  
**Connection to KS:** 5 - 8 A  
**R<sub>i</sub> typical:**  
**Connection to Plunger:** < 10 mΩ  
**Connection to KS:** < 30 mΩ

#### Mounting Hole Size

**in CEM 1 and FR 4:** ∅ 3,49 mm (.1374)

#### Note:

GKS-500 M are screwed into KS-500 M 2,5 using special tools (see page 170/171)

Recommended Screw-in Torque:  
 Min.: 10 Ncm / Max.: 20 Ncm

### Ordering Example

Series	Tip Material 3 = BeCu	Tip Style	Tip Diameter (1/100 mm)	Plating A = Gold	Spring Force (dN)	Collar Height (mm)	Type
--------	--------------------------	-----------	----------------------------	---------------------	----------------------	-----------------------	------

Test Probe:

G K S 5 0 0 3 0 6 3 0 0 A 1 5 0 2 M

Receptacle:

K S - 5 0 0 M 2,5

# GKS 212 M

Screw-in Test Probe

**Grid:**

≥ 2,54 mm

≥ 100 Mil

**Installation Height:** 25,0 mm (.984)

**Recommended Stroke:** 12,0 mm (.472)

## Mounting and Functional Dimensions

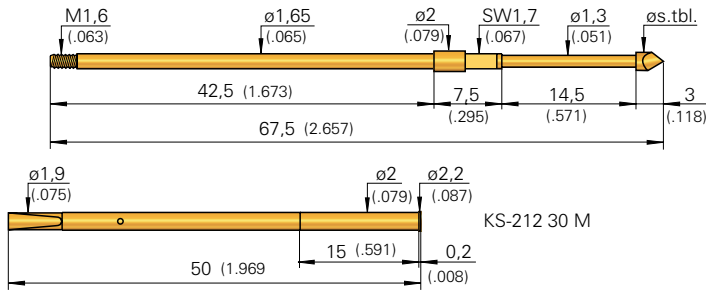

## Available Tip Styles

Material	Tip Style	Plating	Further Versions	
			∅	∅ (inch)
3	06	∅ 2,00 (.079)	A	
3	07	∅ 2,00 (.079)	A	1,50 (.059)

### Collar Height and Installation Height

The Installation Height of the Tip (measured with the Receptacle) is determined by the Collar Height. The Test Probe can only be used with a Receptacle.

Collar Height	Installation Height
07	25 mm (.984)

### Mechanical Data

**Working Stroke:** 12 mm (.472)  
**Maximum Stroke:** 14,5 mm (.571)  
**Spring Force at Work. Stroke:** 3 N (10.8oz)

### Materials

**Plunger:** BeCu, gold-plated  
**Barrel:** Brass, gold-plated  
**Spring:** Steel, gold-plated  
**Receptacle:** Brass, gold-plated

**Note:**

GKS-212 ... M will be screwed into KS-212 30 M using special tools (see Page 170/171).

### Electrical Data

**Current Rating:** 2 - 3 A  
**R<sub>i</sub> typical:** < 20 mΩ

### Mounting Hole Size

**in CEM 1 and FR 4:** ∅ 1,99 mm (.0783)

**Recommended Screw-in Torque:**  
 Min.: 3 Ncm / Max.: 5 Ncm

## Ordering Example

Series	Tip Material 3 = BeCu	Tip Style	Tip Diameter (1/100 mm)	Plating A = Gold	Spring Force (dN)	Collar Height (mm)	Special Designation
--------	--------------------------	-----------	----------------------------	---------------------	----------------------	-----------------------	---------------------

Test Probe:

G K S 2 1 2 3 0 7 2 0 0 A 3 0 0 7 M

Receptacle:

K S - 2 1 2 3 0 M

**Grid:**  
 ≥ 4,50 mm  
 ≥ 177 Mil

**Installation Height:** 19,5 / 25,0 mm (.768 / .984)  
**Recommended Stroke:** 12,0 mm (.472)

### Mounting and Functional Dimensions

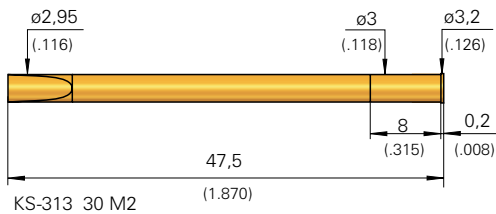
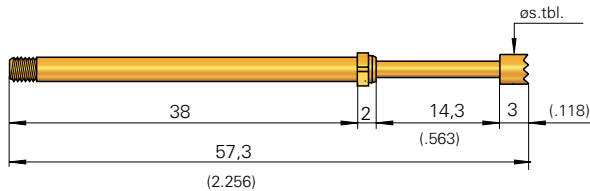
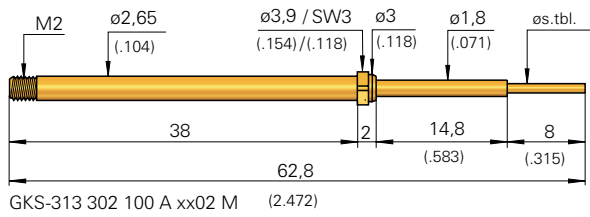

### Available Tip Styles

Material	Tip Style	Plating	Further Versions	
			∅	∅ (inch)
3 02		A		
3 06		A		
3 17		R		

#### Collar Height and Installation Height

The Installation Height of the Tip (measured with the Receptacle) is determined by the Collar Height. The Test Probe can only be used with a Receptacle.

Collar Height	Tip Style	Install. Height
02	02	25,0 mm (.984)
02	06 / 17	19,5 mm (.768)

#### Mechanical Data

**Working Stroke:** 12 mm (.472)  
**Maximum Stroke:** 14,3 mm (.563)  
**Spring Forces at Work. Stroke:** 1,5 N (5.4oz)  
**alternative:** 3,0 N (10.8oz)

#### Materials

**Plunger:** BeCu, gold- or rhodium-plated  
**Barrel:** Brass, gold-plated  
**Spring:** Steel, gold-plated  
**Receptacle:** Brass, gold-plated

#### Note:

GKS-313 ... M will be screwed into KS-313 ... M2 using special tools (see Page 170/171).

Recommended Screw-in Torque:  
 Min.: 10 Ncm / Max.: 20 Ncm

#### Electrical Data

**Current Rating:** 3 - 5 A  
**R<sub>i</sub> typical:** ≤ 30 mΩ

#### Mounting Hole Size

in CEM 1 and FR 4: ∅ 2,99 mm (.1177)

### Ordering Example

Series	Tip Material 3 = BeCu	Tip Style	Tip Diameter (1/100 mm)	Plating A = Gold	Spring Force (dN)	Collar Height (mm)	Special Designation
--------	--------------------------	-----------	----------------------------	---------------------	----------------------	-----------------------	---------------------

Test Probe:

G K S 3 1 3 3 0 2 1 0 0 A 3 0 0 2 M

Receptacle:

K S - 3 1 3 3 0 M 2

# GKS 913 M

Short-stroke Screw-in Test Probe

## Grid:

≥ 4,00 mm

≥ 160 Mil

Installation Height: 7,2 / 8,7 mm (.283 / .343)

Recommended Stroke: 2,8 mm (.110)

## Mounting and Functional Dimensions

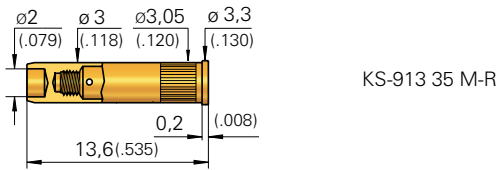
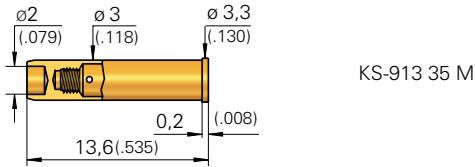
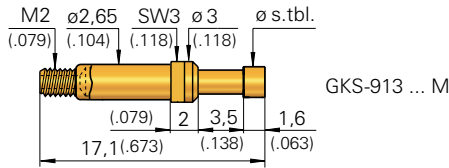

## Available Tip Styles

Material	Tip Style	Plating	Further Versions	
			∅	∅ (inch)
1 02		A	3,50	(.138)
3 03		A		
3 05		A		
3 06*		A		
3 06		A	3,50 R 2,30 R	(.138) (.091)
3 08		R		
3 58**		R		

Tip Length 3,4 mm (.134)

## Collar Height and Installation Height

The Installation Height of the Tip is determined by the Collar Height.

Collar Height	Tip Style	Install. Height (without KS)	max. Stroke
02	02/05/06/08	7,2 mm (.283)	3,5 mm (.138)
02	06 180*	7,2 mm (.283)	3,2 mm (.126)
02	58**	8,7 mm (.343)	3,3 mm (.130)

## Mechanical Data

**Working Stroke:** 2,8 mm (.110)

**Maximum Stroke:** see Table

**Spring Force at Work. Stroke:** 1,5 N (5.4oz)

**alternative:** 0,8 N (2.9oz); 2,5 N (9.0oz)

## Electrical Data

**Current Rating:** 5 - 8 A

**R<sub>i</sub> typical:** < 20 mΩ (\*\*\*) < 100 mΩ)

\*\*\* Spring force < 1,5 N are not recommended for high-current applications

## Operating Temperature

**Standard:** -40° up to +80° C

\*\*\* with Spec. Design. "C": -100° up to +200° C (1,5 N)

## Materials

**Plunger:** Brass or BeCu,

gold- or rhodium-plated

**Barrel:** Brass, gold-plated

**Spring:** Steel, gold-plated

or Stainless Steel\*\*\* (C)

**Receptacle:** Brass, gold-plated

## Mounting Hole Size

**in CEM 1 and FR 4:**

**with KS-913 35 M:**

∅ 2,98 - 2,99 mm  
(.1173 - .1177)

**for KS-913 35 M- R**

**in CEM 1 and FR 4:**

∅ 3,00 - 3,02 mm  
(.1181 - .1189)

## Note:

The Receptacle KS-913 35 M (-R) can only be combined with the Probe Type „GKS-913 ... M“

## For applications up to 24 A:

see HSS-520 on Page 106

## Note:

GKS-913 ... M will be screwed into KS-913 35 M (-R) using special tools (see Page 170/171).

## Recommended Screw-in Torque:

Min.: 5 Ncm / Max.: 10 Ncm

## Ordering Example

Series	Tip Material	Tip Style	Tip Diameter (1/100 mm)	Plating	Spring Force (dN)	Collar Height (mm)	Typ M, MC
	1 = Brass 3 = BeCu			A = Gold R = Rhodium			

Test Probe:

G K S 9 1 3 3 0 8 2 3 0 R 1 5 0 2 M

Receptacle:

K S - 9 1 3 3 5 M    K S - 9 1 3 3 5 M - R

# Screw-in High-current Probes

In the case of Screw-in High-current Probes the Plunger is also split in two sections, so that during the stroke action the two sections are deflected apart in the radial direction and subsequently the cross-section of the signal transfer zone is enlarged. With this, higher currents can be transferred.

By means of the thread the High-current Probe is secured in the Receptacle. Especially in the case of assembly upside down or by a higher cycle rate, the Screw-in Test Probes offer a high level of reliability.



HSS...M

# Screw-in High-current Probes

HSS-118 M	144
HSS-120 M	145
HSS-150 M	146
HSS-552 M	146

HSS-520 M	106
HSS-827 M	129

Insertable Test Probes HSS from page 103 on.

# HSS 118 M

Screw-in High-Current Test Probe

**Grid:**

≥ 2,54 mm

≥ 100 Mil

**Installation Height:** 10,5 mm (.413)

**Recommended Stroke:** 4,0 mm (.157)

## Mounting and Functional Dimensions

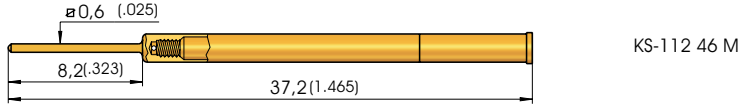
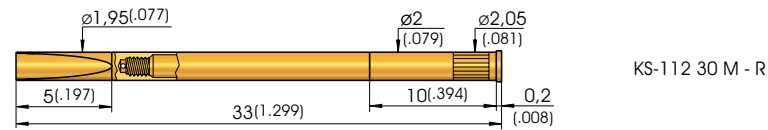
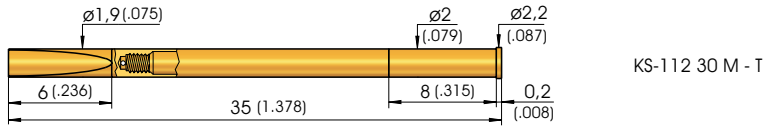
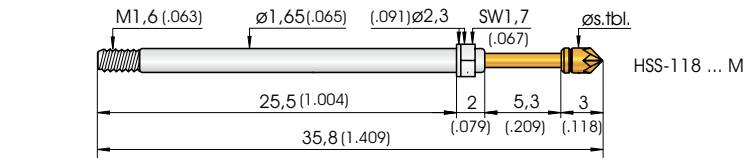

\*\*\*\* axially positioned trough-hole for leakage test. Attention: when not assembled correctly, then solder can flow inside the receptacle.

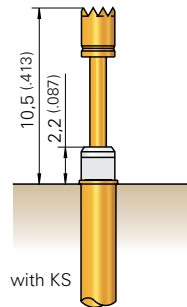

### Collar Height and Installation Height

The Installation Height of the Tip is always 10,5 mm (.413). Test Probe can only be used with Receptacle.

### Mechanical Data

**Working Stroke:** 4,0 mm (.157)

**Maximum Stroke:** 5,3 mm (.209)

For Tip Diameter < 1,0 mm:

**Maximum Stroke:** 8,0 mm (.315)

**Spring Force at Work. Stroke:** 1,5 N (5.4oz)

**alternative:** 0,8 N (2.9oz)\*; 2,25 N (8.1oz)

### Electrical Data

**Current Rating:** max. 16 A, with Spring Force ≥ 1,5 N, and Plunger made of BeCu

**R<sub>i</sub> typical:** ≤ 10 mΩ

\* Spring force < 1,5 N are not recommended for high-current applications

### Materials

**Plunger:** Steel or BeCu, gold-plated

**Barrel:** Brass, silver-plated

**Spring:** Stainless Steel

**Receptacle:** Brass, gold-plated

### Mounting Hole Size

**for KS-112 xx M**

**in CEM 1 and FR 4:** ø 1,99 mm (.0783)

**for KS-112 xx M - R**

**in CEM 1 and FR 4:** ø 2,00 - 2,02 mm (.0787 - .0795)

### Operating Temperature

**Standard:** -100° - +200°C

## Available Tip Styles

Material	Tip Style	Plating	Further Versions	
			ø	ø (inch)
3 02		A		
3 03		A		
3 05		A	0,65	(.026)
3 05		A		
3 05**		S		
3 06		A	1,30 1,60 1,80 2,50 3,50	(.051) (.063) (.070) (.098) (.138)
2 14		A		
3 17		A	2,00	(.079)
3 19		A		
3 53***		S		

\*\* pressed-in Silver stud

\*\*\* pressed-in Silver stud

Tip Length 3,5 mm (.138),

Installation Height plus 0,5 mm (.020)

### Applications:

- High-current transfer during Functional Test
- Power-Supply Test
- Burn-In Test
- Contacting element in permanent use
- Usage with AC and DC

### Note:

HSS-118 ... M will be screwed into KS-112 ... M using special tools (see Page 170/171).

**Recommended Screw-in Torque:**  
Min.: 3 Ncm / Max.: 5 Ncm

## Ordering Example

Series	Tip Material	Tip Style	Tip Diameter (1/100 mm)	Plating	Spring Force (dN)	Collar Height (mm)	Special Designation „M“
	2 = Steel 3 = BeCu			A = Gold S = Silver			

Test Probe:

H S S 1 1 8 3 1 7 1 7 5 A 1 5 0 2 M

Receptacle for HSS-118 ... M:

K S - 1 1 2 3 0 M / M-R / M-T K S - 1 1 2 4 6 M

Receptacle for Leakage Test \*\*\*\*:

K S - 1 1 2 3 0 M



**Grid:**  
 ≥ 4,00 mm  
 ≥ 160 Mil

**Installation Height:** 10,5 mm (.413)  
**Recommended Stroke:** 4,0 mm (.157)

### Mounting and Functional Dimensions

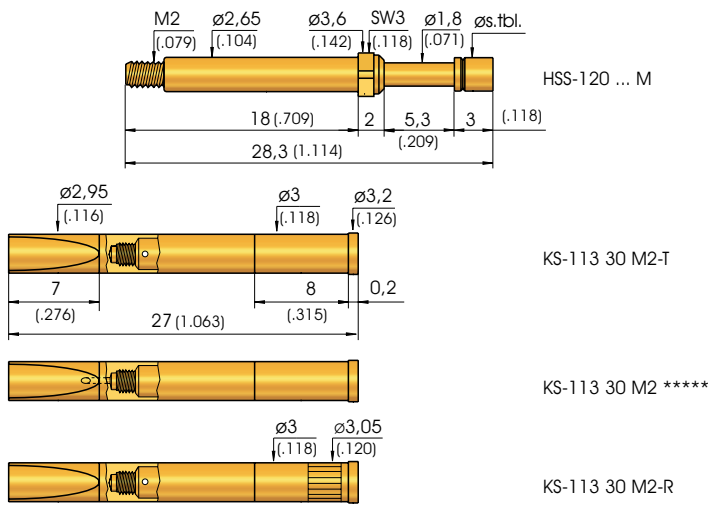

\*\*\*\* axially positioned through-hole for leakage test. Attention: when not assembled correctly, then solder can flow inside the receptacle.

#### Collar Height and Installation Height

The Installation Height of the Tip (Dimension with Receptacle) is determined by the Collar Height. Test Probes can only be used with Receptacle.

Collar Height	Installations Height with Receptacle
02 M	10,5 mm (.413)

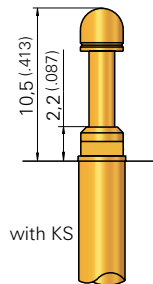

#### Mechanical Data

**Working Stroke:** 4,0 mm (.157)  
**Maximum Stroke:** 5,3 mm (.209)  
**Spring Force at Work. Stroke:** 1,5 N (5.4oz)  
**alternative:** 0,3 N\* (1.1oz); 0,6 N\* (2.2oz);  
 1,0 N\* (3.6oz); 2,25 N (8.1oz);  
 3,0 N (10.8oz)

#### Electrical Data

**Current Rating:** max. 24 A,  
 with Spring Force ≥ 1,5 N  
 and Plunger made of BeCu

\* Spring force < 1,5 N are not recommended for high-current applications

**R<sub>i</sub> typical:** ≤ 10 mΩ

#### Materials

**Plunger:** Steel or BeCu, gold-plated,  
**Barrel:** Brass, gold-plated  
**Spring:** Steel, gold-plated or Stainless Steel  
**Receptacle:** Brass, gold-plated

#### Mounting Hole Size

**for KS-113 30 M2**  
**in CEM 1 and FR 4:**  $\varnothing 2,99$  mm (.1177)  
**for KS-113 30 M2 - R**  
**in CEM 1 and FR 4:**  $\varnothing 3,00 - 3,02$  mm  
 (.1181 - .1189)

#### Operating Temperature

**Standard:** -100° - +200° C

### Available Tip Styles

Material	Tip Style	Plating	Further Versions	
			$\varnothing$	$\varnothing$ (inch)
3 02		A	4,00	(.157)
3 03		A		
3 05		A		
3 05		A	3,00	(.118)
3 05		S		
3 06		A	3,00 4,00	(.118) (.157)
3 17		A		
3 19		A		
2 51		A		
3 53		S		
3 55		A		

\*\* Tip Length 5 mm (.197) - Installation Height with Collar Height 02: 12,5 mm (.492)

\*\*\* pressed-in Silver stud

\*\*\*\* pressed-in Silver stud, Tip Length 3,5 mm (.138)  
 Installation Height plus 0,5 mm (.020)

#### Applications:

- High-current transfer during Functional Test
- Power-Supply Test
- Burn-In Test
- Contacting element in permanent use
- Usage with AC and DC

#### Note:

HSS-120 ... M will be screwed into KS-113 ... M using special tools (see Page 170/171).

Recommended Screw-in Torque:  
 Min.: 10 Ncm / Max.: 20 Ncm

### Ordering Example

Series	Tip Material	Tip Style	Tip Diameter (1/100 mm)	Plating	Spring Force (dN)	Collar Height (mm)	Special Designation
	2 = Steel 3 = BeCu			A = Gold S = Silver			

Test Probe:

H S S 1 2 0 3 0 6 3 0 0 A 1 5 0 2 M

Receptacles for HSS-120 ... M:

K S - 1 1 3 3 0 M 2 - T K S - 1 1 3 3 0 M 2 - R

Receptacle for Leakage Test \*\*\*\*\*:

K S - 1 1 3 3 0 M 2

# HSS 150 M / HSS 552 M

Screw-in High-Current Test Probe

**Grid:**

≥ 5,08 mm

≥ 200 Mil

**Installation Height:** 10,8/13,8 mm (.425/.543)/7,5 mm (.295)

**Recommended Stroke:** 4,4/7,4 mm (.173/.291)/2,0 mm (.079)

## Mounting and Functional Dimensions

### HSS-150 ... M

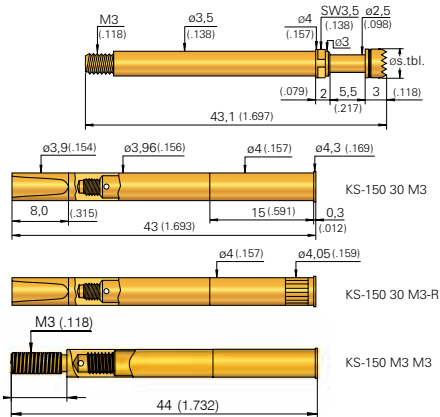

### HSS-150 ... MH

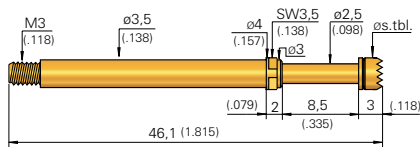

### HSS-552 ... M

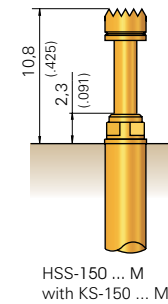
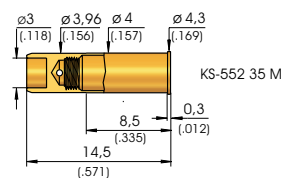
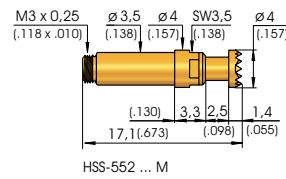

### Collar Height and Installation Height

The Installation Height of the Tip (Dimensions with Receptacle) is determined by the Collar Height.

Collar Height/Tip	Installation Height (with Receptacle) in mm
02 M	10,8 (.425) HSS 150...M
02 MH	13,8 (.543) HSS 150...M (MH)
03 M	7,5 (.295) HSS 552...M

### \* Tip Style 05 S:

The pressed-in silver stud prevents burning or welding of the Test Probe to the test point.

### Mechanical Data HSS 150... M (MH)

**Working Stroke:** 4,4 mm (.173)

Typ „MH“: 7,4 mm (.291)

**Maximum Stroke:** 5,5 mm (.217)

Typ „MH“: 8,5 mm (.335)

**Spring Force at Work. Stroke:** 3,0 N (10.8oz)

**alternative:** 5,0 N (18.1oz); 10 N (36 oz); („99“ in ordering number)

### Mechanical Data HSS 552... M

**Working Stroke:** 2,0 mm (.079)

**Maximum Stroke:** 2,5 mm (.098)

**Spring Force at Work. Stroke:** 2,0 N (7.2oz)

### Operating Temperature

**Standard:** -100° up to +200° C

### Materials

#### Plunger:

BeCu, gold-plated or with Silver stud

#### Barrel:

Brass, gold-plated

#### Spring:

Stainless Steel

#### Receptacle:

Brass, gold-plated

### Mounting Hole Size

**for KS-150 30 M3 + KS-150 M3 M3 + HSS-552 35 M**

**in CEM 1 and FR 4:** ø 3,99 mm (.1571)

**for KS-150 30 M3-R:** ø 4,0 - 4,02 mm (.1575 - .1583)

### Electrical Data

**Current Rating:** 50 A

for short loads up to 80 A

**R<sub>i</sub> typical:** ≤ 10 mΩ

### Available Tip Styles HSS-150 M

Material	Tip Style	Plating	Further Versions	
			ø	ø (inch)
3	02	A	ø 4,00 (.157)	
3	03	A	ø 4,00 (.157)	
3	05*	S	ø 4,00 (.157)	
3	06	A	ø 4,00 (.157)	3,00 (.118)
3	17	A	ø 3,00 (.118)	
3	19	A	ø 4,00 (.157)	

\* pressed-in Silver stud

### Available Tip Styles Special Version HSS-150... MH

Material	Tip Style	Plating	Further Versions	
			ø	ø (inch)
3	02	A	ø 4,00 (.157)	
3	05*	S	ø 4,00 (.157)	
3	06	A	ø 4,00 (.157)	
3	17	A	ø 4,00 (.157)	

Total Length 46,1 mm (1.815), Special Designation „MH“

\* pressed-in Silver stud

### Available Tip Styles HSS-552 M

Material	Tip Style	Plating	Further Versions	
			ø	ø (inch)
3	06	A	ø 4,00 (.157)	

### Note:

HSS-150 ... M and HSS 552 M will be screwed into KS-150 ... M3 and KS-552 ... M using special tools (see Page 170/171).

**Recommended Screw-in Torque:**  
Min.: 10 Ncm / Max.: 20 Ncm

## Ordering Example

Series	Tip Material	Tip Style	Tip Diameter (1/100 mm)	Plating	Spring Force (dN)	Collar Height (mm)	Type (alternative MH)
3 = BeCu	A = Gold S = Silver						

Test Probe:

H S S 1 5 0 3 0 3 4 0 0 A 3 0 0 2 M

Test Probe:

H S S 1 5 0 3 0 6 4 0 0 A 3 0 0 2 M H

Test Probe:

H S S 5 5 2 3 0 6 4 0 0 A 2 0 0 3 M

Receptacle for HSS-150 ... M:

K S - 1 5 0 3 0 M 3 K S - 1 5 0 3 0 M 3 - R K S - 1 5 0 M 3 M 3

Receptacle for HSS-552 ... M:

K S - 5 5 2 3 5 M

# Screw-in Switching Probes

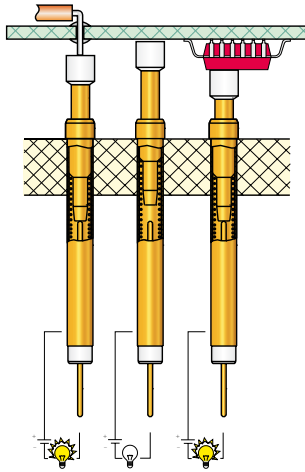

To check the presence of a component, Switching Probes with an insulated tip are normally used.

The example on the left explains the functionality: Should the component be present, then the plunger is pressed down and the contact is closed. Should the component not be present, then the plunger is not activated and the Switching Probe remains open.

# Screw-in Switching Probes

SKS-215 M/MF <b>NEW</b>	148
SKS-465 MF	149
SKS-465 SF	150
SKS-435 M	151

Insertable Test Probes SKS from page 77 on.

# SKS 215 M / 215 MF

Screw-in Switching Probe

NEW

Grid:

≥ 2,54 mm

≥ 100 Mil

Installation Height: 10,2 - 20,0 mm (.402 - .787)

Switching Path: 1,5 mm (.059)

## Mounting and Functional Dimensions

### SKS-215 ... M

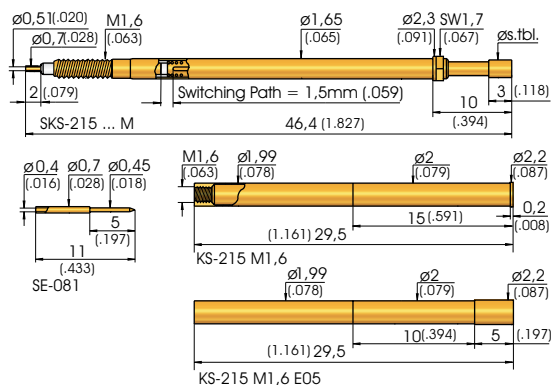

### Quick-exchange System

#### SKS-215 ... MF

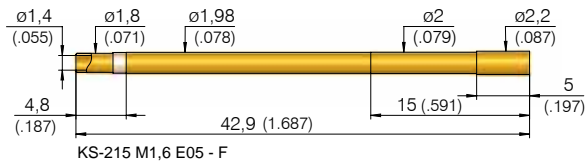
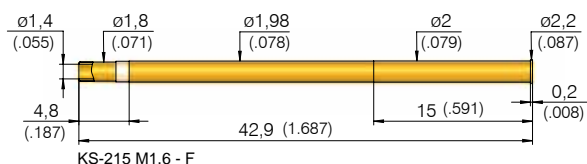
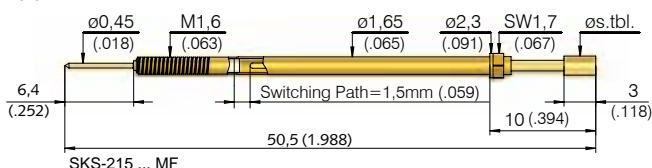

KS-215 M1,6 - F - R (with Knurl)

KS-215 M1,6 E05 - F - R (with Knurl)

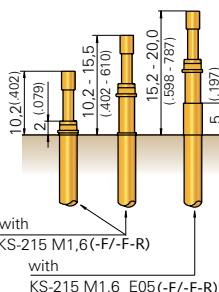

## Available Tip Styles

Material	Tip Style	Plating	Further Versions	
			Ø	Ø (inch)
0 02		A		
3 02		A	1,00	(.039)
3 03		A		
3 05		A	0,80	(.030)
3 05		A		
3 06		N	1,50	(.059)
3 19		A		

### Collar Height and Installation Height

Crimps in the Receptacle prevent the Test Probe from rotating. Different Installation Heights can be variably achieved with different Receptacles.

Designation	Install. Heights
KS-215 M1,6 (-F/-F-R)	10,2 - 15,5 mm (.402 - .610)
KS-215 M1,6 E05 (-F/-F-R)	15,2 - 20,0 mm (.598 - .787)

### Note:

SKS-215 ... M will be screwed into KS-215 ... M using special tools (see Page 170/171). Recommended Screw-in Torque: Min.: 3 Ncm / Max.: 5 Ncm

### Quick-exchange Receptacles:

Receptacles with end designation „-F“ are quick-exchange Receptacles. The two wires are soldered to the outside wall of the Receptacle and the central Terminal point. This is done after assembling the Receptacle in the Mounting Hole. The Switching Probe can now be inserted or changed without any further soldering work.

The Quick-exchange system „F“ is not compatible with the previous version „S“. This is still available on request.

### Mechanical Data

**Switching Path:** 1,5 mm (.059)  
± 0,2 mm (.008)

**Working Stroke:** 4,0 mm (.160)

**Maximum Stroke:** 5,0 mm (.197)

**Force at Switching Point:** 0,23 N (.8 oz);  
0,45 N (1.6 oz); 0,9 N (3.2 oz)

**Force at Working Stroke:** 0,80 N (2.9 oz);  
1,50 N (5.4 oz); 3,0 N (10.7 oz)

### Electrical Data

**Current Rating:** 3 A  
(see Page 77)

### Materials

**Plunger:** BeCu, gold- or nickel-plated  
(or gold-plated with Insulator Cap)

**Barrel:** Brass, gold-plated

**Spring:** Steel, gold-plated

**Receptacle:** Brass, gold-plated

### Mounting Hole Size

in CEM 1 and FR 4: Ø 1,99 mm (.0783)

## Ordering Example

Series	Tip Material	Tip Style	Tip Diameter (1/100 mm)	Plating	Spring Force at Working Stroke (dN)	Collar Height (mm)	Type (alternative „MF“)
	0 = Delrin 3 = BeCu			A = Gold N = Nickel			

Test Probe:

S K S 2 1 5 3 0 2 1 8 0 A 3 0 0 2 M

Receptacles:

K S - 2 1 5 M 1,6 (-F / -F-R) K S - 2 1 5 M 1,6 E 0 5 (-F / -F-R)

Plug:

S E - 0 8 1

**Grid:**  
 ≥ 3,50 mm  
 ≥ 140 Mil

**Installation Height:** 10,5 - 26,5 mm (.413 - 1.043)

**Switching Path:** 1,7 mm (.067)

### Mounting and Functional Dimensions

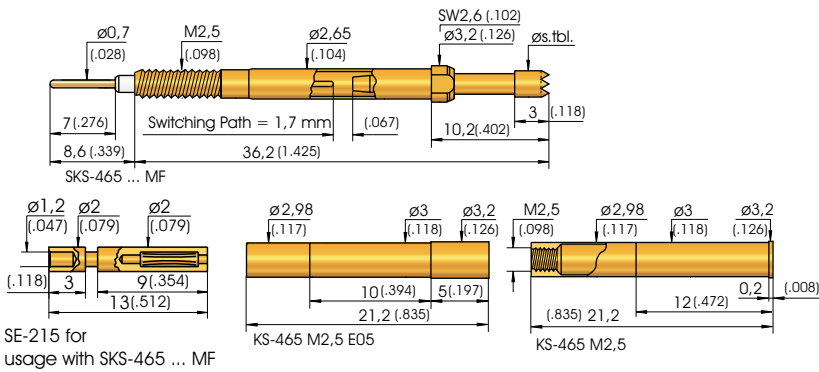

### Quick-exchange System

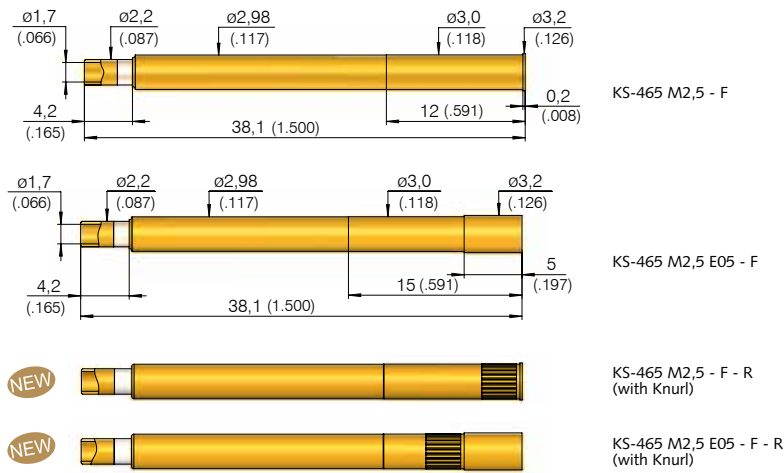

### Available Tip Styles

Material	Tip Style	Plating	Further Versions	
			∅	∅ (inch)
0 02		A	5,00 2,30	(.197) (.091)
3 02		A		
3 02		A		
3 03		A		
3 06		A		
3 06		A		
3 06		A	4,00	(.157)
3 19		A		
3 53*		A		
3 56*		A		
3 56*		A		
3 56*		A		

\* Tip Length 9,5 mm (.374)

### Collar Height and Installation Height

Crimps in the Receptacle prevent the Test Probe from rotating. Different Installation Heights can be variably achieved with different Receptacles.

Designation of the Receptacle	Install. Heights with Tips 02/03/06	Install. Height with Tips 53/56
KS-465 M2,5 (-F/-F-R)	10,5 - 15,5 mm (.413 - .610)	17,0 - 22,0 mm (.669 - .866)
KS-465 M2,5 E05 (-F/-F-R)	15,2 - 20,0 mm (.598 - .787)	21,7 - 26,5 mm (.854 - 1.043)

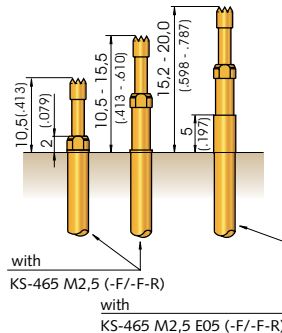

### Quick-exchange Receptacles:

Receptacles with end designation „-F“ are quick-exchange Receptacles. The two wires are soldered to the outside wall of the Receptacle and the central Terminal point. This is done after assembling the Receptacle in the Mounting Hole. The Switching Probe can now be inserted or changed without any further soldering work.

The Quick-exchange system „F“ is not compatible with the previous version „S“. This is still available on request.

### Note:

Probes with Tip Diameter ≤ 3,0 are screwed into KS-465...M using tools, see Page 170/171. Test Probes SKS-465 ... MF with Tip Diameter > 3,0 mm using special tools (special tools on request). Recommended Screw-in Torque: Min.: 3 Ncm / Max.: 5 Ncm

### Mechanical Data

**Switching Path:** 1,7 mm (.067)  
 ± 0,3 mm (.012)  
**Recomm. Work. Stroke:** 4,2 mm (.165)  
**Maximum Stroke:** 5,2 mm (.205)  
**Force at Switching Point:** 0,7 N (2.5oz);  
 1,8 N (6.5oz); 4,5 N (15oz)  
**Force at Work. Stroke:** 2,0 N (7.2oz);  
 3,5 N (12.7oz); 9,0 N (32.5oz)

### Materials

**Plunger:** BeCu, gold-plated  
 with or without Insulator Cap  
**Barrel:** Brass, gold-plated  
**Spring:** Stainless Steel  
**Receptacle:** Brass, gold-plated  
**Insulation:** Teflon

### Mounting Hole Size

**in CEM 1 and FR 4:** ∅ 2,98 - 2,99 mm (.1173 - .1177)

### Electrical Data

**Current Rating:** 3 A  
 (see Page 77)

### Ordering Example

	Series	Tip Material	Tip Style	Tip Diameter (1/100 mm)	Plating	Spring Force at Working Stroke (dN)	Collar Height (mm)	Type
Test Probe:	SKS	0 = Delrin 3 = BeCu	465	306	A = Gold	230	2002	MF
Receptacles:	KS-465		M2,5 (-F/-F-R)	KS-465		M2,5 E05 (-F/-F-R)		
Lamellar Plug:	SE-215							



# SKS 465 SF

Screw-in Switching Probe

## Grid:

≥ 3,50 mm

≥ 140 Mil

Installation Height: 10,5 - 26,5 mm (.413 - 1.043)

Switching Path: 1,7 mm (.067)

## Mounting and Functional Dimensions

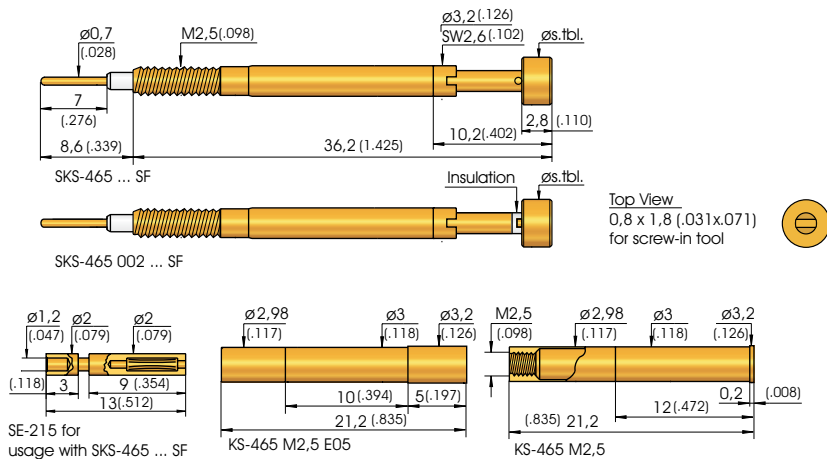

## Available Tip Styles

Material	Tip Style for SKS-465 302 / 352 ... S	Plating	Further Versions	
			∅	∅ (inch)
3 02		A	3,50	(.138)
			4,00	(.157)
3 02		A	5,00	(.197)
			5,50	(.217)
3 52*		A	3,50	(.138)

\* 6,5 mm (.256) longer

## Available Tip Styles

Material	Tip Style for SKS-465 002 ... S with insulated Tip	Plating	Further Versions	
			∅	∅ (inch)
0 02		A	3,50	(.138)
			4,00	(.157)
0 02		A	5,00	(.197)
			5,90	(.232)

## Quick-exchange System

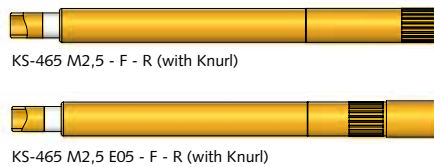
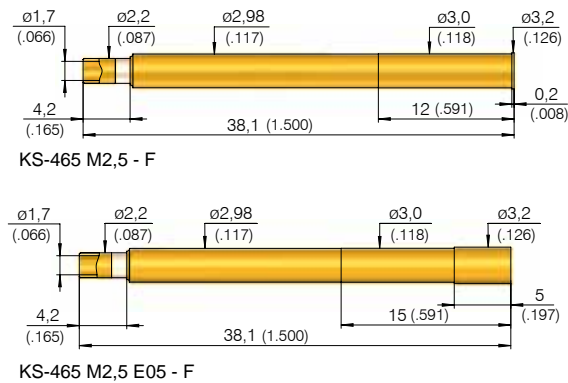

## Collar Height and Installation Height

Crimps in the Receptacle prevent the Test Probe from rotating. Different Installation Heights can be variably achieved with different Receptacles.

Designation of the Receptacle	Install. Heights with Tips 02 or 002	Install. Height with Tips 52
KS-465 M2,5 (-F/-F-R)	10,5 - 15,5 mm (.413 - .610)	17,0 - 22,0 mm (.669 - .866)
KS-465 M2,5 E05 (-F/-F-R)	15,2 - 20,0 mm (.598 - .787)	21,7 - 26,5 mm (.854 - 1.043)

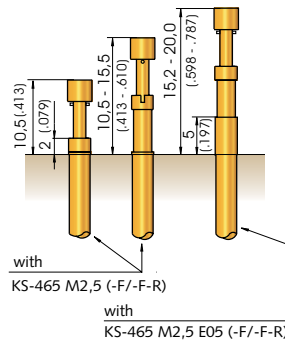

## Quick-exchange Receptacles:

Receptacles with end designation „-F“ are quick-exchange Receptacles. The two wires are soldered to the outside wall of the Receptacle and the central Terminal point. This is done after assembling the Receptacle in the Mounting Hole.

The Switching Probe can now be inserted or changed without any further soldering work.

The Quick-exchange system „F“ is not compatible with the previous version „S“. This is still available on request.

## Note:

The Test Probes of the Series SKS-465 ... SF using special tools (see Page 170/171)

Recommended Screw-in Torque: Min.: 3 Ncm / Max.: 5 Ncm

## Mechanical Data

**Switching Path:** 1,7 mm (.067) ± 0,3 mm (.012)

**Recomm. Work. Stroke:** 4,2 mm (.165)

**Maximum Stroke:** 4,5 mm (.177)

**Force at Switching Point:** 0,7 N (2.5oz); 1,8 N (6.5oz); 4,5 N (15oz)

**Force at Work. Stroke:** 2,0 N (7.2oz); 3,5 N (12.7oz); 9,0 N (32.5oz)

## Materials

**Plunger:** BeCu or Brass, gold-plated

**Barrel:** Brass, gold-plated

**Spring:** Steel, gold-plated or Stainless Steel

**Receptacle:** Brass, gold-plated

**Insulation:** Teflon (at Tip „002“: Peek)

## Mounting Hole Size

**in CEM 1 and FR 4:** ∅ 2,98 - 2,99 mm (.1173 - .1177)

## Electrical Data

**Current Rating:** 3 A (see Page 77)

## Ordering Example

Series	Tip Material 0 = Peek 3 = BeCu	Tip Style	Tip Diameter (1/100 mm)	Plating A = Gold	Spring Force at Working Stroke (dN)	Collar Height (mm)	Type
--------	--------------------------------------	-----------	----------------------------	---------------------	-------------------------------------	--------------------	------

Test Probe:

SKS 465 3 02 450 A 20 02 SF

Receptacles:

KS - 465 M2,5 (-F / -F-R) KS - 465 M2,5 E05 (-F / -F-R)

Lamellar Plug:

SE - 215



Grid:  
 ≥ 4,50 mm  
 ≥ 177 Mil

Installation Height: 20,8 mm (.819)  
 Switching Path: 6,0 mm (.236)

## Mounting and Functional Dimensions

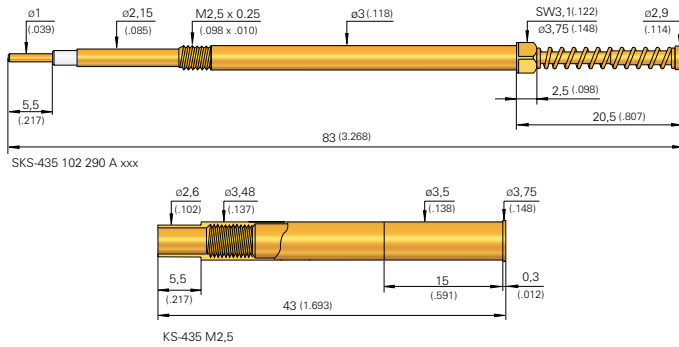

## Available Tip Styles

Material	Tip Style	Plating	Further Versions	
			∅	∅ (inch)
1	02	A	∅ 2,90 (.114)	

### Collar Height and Installation Height

The Installation Height of the Tip is always 20,8 mm (.819) (Dimensions with Receptacle). Test Probe can only be used with Receptacle.

### Mechanical Data

**Switching Path:** 6,0 mm (.236)  
 ± 0,2 mm (.008)  
**Maximum Stroke:** 8,0 mm (.315)  
**Force at Switching Point:** 13,5 N (48.6oz);  
 18,5 N (66.6oz); 23,5 N (84.6oz)  
**Force at 80% Force:** 13,5 N (48.6oz);  
 18,5 N (66.6oz); 23,5 N (84.6oz)

### Electrical Data

**Current Rating:** 3 A  
 (see Page 77)

### Materials

**Plunger:** Brass, gold-plated  
**Barrel:** Brass, gold-plated  
**Spring:** Steel, gold-plated or Stainless Steel  
**Receptacle:** Brass, gold-plated  
**Insulation:** Teflon

### Mounting Hole Size

**in CEM 1 and FR 4:** ∅ 3,48 - 3,49 mm  
 (.1370 - .1374)

### Note:

SKS-435 ... M will be screwed into KS-435 M2.5 using special tools (see Page 170/171).

Recommended Screw-in Torque:  
 Min.: 10 Ncm / Max.: 20 Ncm

## Ordering Example

Series	Tip Material 1 = Brass	Tip Style	Tip Diameter (1/100 mm)	Plating A = Gold	Spring Force (dN)	Type
--------	---------------------------	-----------	----------------------------	---------------------	----------------------	------

Test Probe:

S K S 4 3 5 1 0 2 2 9 0 A 1 3 5 M

Receptacle:

K S - 4 3 5 M 2 . 5

# Classical RF-Applications

Impedance  $50 \Omega$

Examples: DAB, GPS and Telecommunication

For a complete overview of all available testing solutions please see current RF Catalog.

FAKRA Signal  
Conductor Plug



FAKRA Signal  
Conductor Jack



GT13 Signal  
Conductor Plug



GT16 Signal  
Conductor Plug



GT16 Signal  
Conductor Jack



## Customizing and connecting example

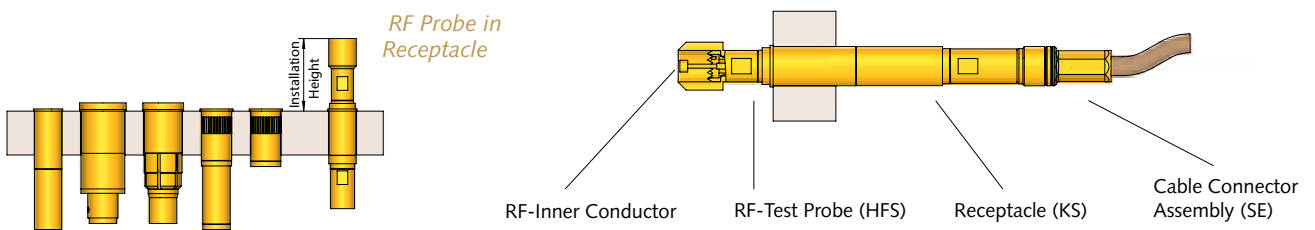

Receptacles for press-in, screw-in or float mounted versions are available.

# RF/Digital



For more information  
please have a look at the  
current RF-Catalog

Classical RF-Applications	NEW	152
Digital RF-Applications	NEW	154



# Digital RF-Applications

With differential impedance  
Examples: USB, HDMI and control signal

HSD Signal Conductor Plug

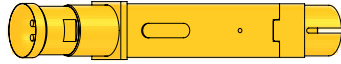

HSD Signal Conductor Jack



MX49 Signal Conductor Jack

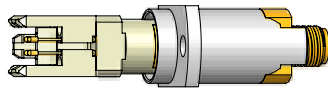

## Customizing and connecting example

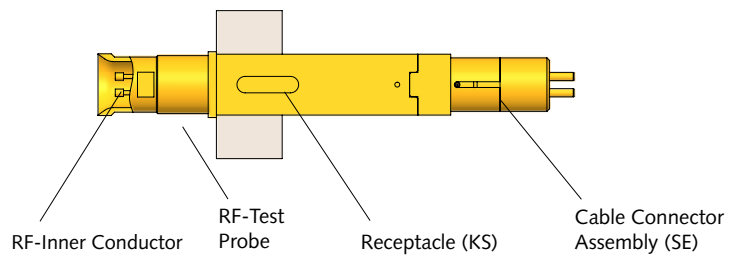
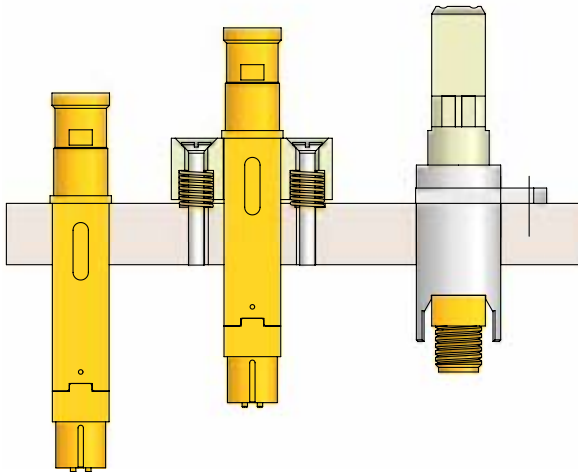

*RF-Probe without Receptacle*

*RF-Probe with flexible Mounting*

*RF-Probe with flange*

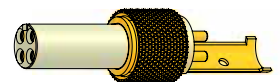

For a complete overview of all available testing solutions please see current RF Catalog.

# Non-rotating Probes

To avoid damage of the connector housing when rectangular or so-called spade-headed tip-styles are used, it is eminent to ensure that the home-position of the Probe does not change. Therefore, non-rotating Probes are designed in such a way that the plunger head is guided by force and subsequently rotating is prevented.

Solely when the Probe is pressed/screwed into the Receptacle is it necessary to set the desired position of the plunger head.

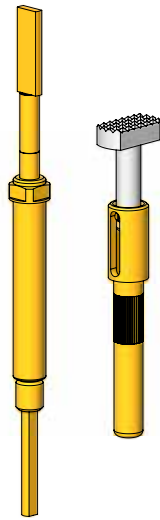

# Non-rotating Probes

GKS-803 M	156
GKS-710	157
GKS-714	158
GKS-098	158
GKS-098 M	159
GKS-746 M	160
GKS-747 M	161

# GKS 803 M

Screw-in Test Probe with continuous Plunger

## Grid:

≥ 4,50 mm

≥ 177 Mil

Installation Height: 18,0 mm (.709)

Recommended Stroke: 6,4 mm (.252)

## Mounting and Functional Dimensions

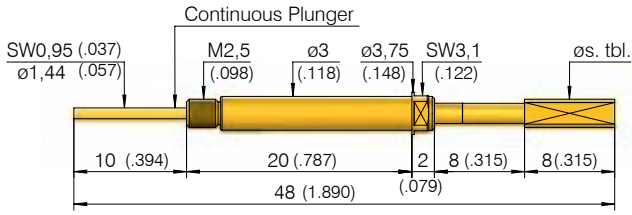

GKS-803 ... M

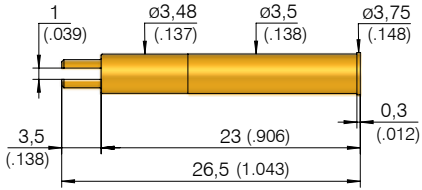

KS-803 M 2,5

## Available Tip Styles

Material	Tip Style	Plating	Further Versions	
			∅	∅ (inch)
1 02	0,8 ∅2,5 208	A		
1 02	1,6 ∅2,5 216	A		
3 02	∅ 2,30 (.091)	A		
3 06	∅ 3,00 (.118)	A		

### Collar Height and Installation Height

The Installation Height of the Tip is determined by the Collar Height.

Collar Height	Installation Height
02	18,0 mm (.709)

### Mechanical Data

**Working Stroke:** 6,4 mm (.252)  
**Maximum Stroke:** 8,0 mm (.315)  
**Spring Force at Work. Stroke:** 1,5 N (5.4oz);  
 5,0 N (18.1oz)

### Materials

**Plunger:** BeCu, gold-plated  
**Plunger head:** BeCu or Brass, gold-plated  
**Barrel:** Brass, gold-plated  
**Spring:** Stainless Steel  
**Receptacle:** Brass, gold-plated

### Electrical Data

**Current Rating:** 5 - 15 A  
**R<sub>i</sub> typical:** < 30 mΩ

### Mounting Hole Size

**in CEM 1 and FR 4:** ∅ 3,49 mm (.1374)

### Note:

When screwing in the Test Probe into the Receptacle the Plunger is secured against rotation. (The flat section at the end of the Plunger moves into the slit at the end of the Receptacle.)

### Note:

Plunger tip with flat section: the flat section of the plunger tip is set at 90° to the flat section at the end of the Plunger.

### Note:

GKS-803 ... M will be screwed into KS-803 M2.5 using special tools (see Page 170/171).

Recommended Screw-in Torque:  
 Min.: 10 Ncm / Max.: 20 Ncm

## Ordering Example

Series	Tip Material 1 = Brass 3 = BeCu	Tip Style	Tip Diameter (1/100 mm)	Plating A = Gold	Spring Force (dN)	Collar Height (mm)	Type
Test Probe:	G K S	8 0 3	3 0 6	3 0 0	A	1 5	0 2 M
Receptacle:	K S - 8 0 3 M 2.5						



**Grid:**  
 ≥ 2,54 mm  
 ≥ 100 Mil  
**Installation Height:** see below  
**Recommended Stroke:** 4,0 mm (.157)

## Mounting and Functional Dimensions

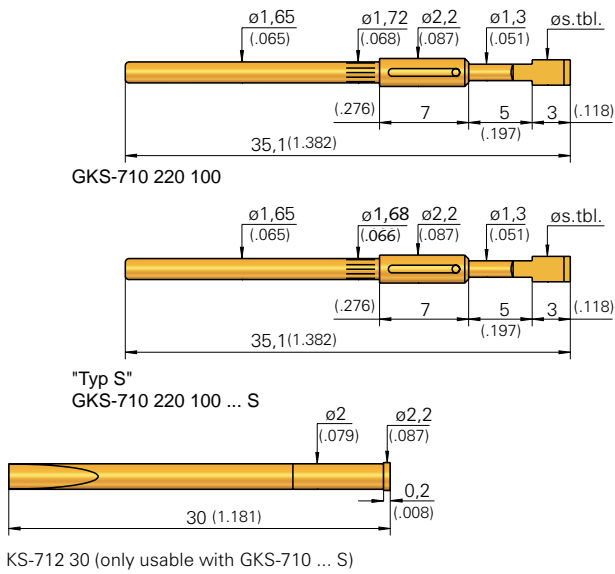

Material		Tip Styles		Plating	Further Versions	
					Install. Height (without KS)	∅/ Plating
2	20			1,00 (.039)	A	15
2	20			0,50 (.020)	R A	18 (.709) / 0,40/R (.016)
2	21			0,50 (.020)	A	15 (.591) / 1,30/A (.051)
2	22			∅ 2,00 (.079)	A	15 (.591)
2	23			∅ 1,30 (.051)	R	13 (.512)
2	26			2,00 (.079)	A	15 (.591)

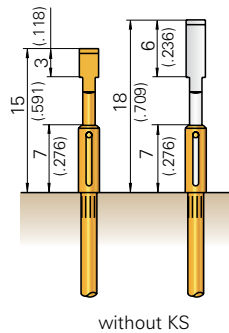

### Collar Height and Installation Height

The Installation Height at the Tip (Dimension without KS) is determined by the Collar Height and the Tip Length (see Table „Available Tip Styles“).

### Mechanical Data

**Working Stroke:** 4,0 mm (.157)  
**Maximum Stroke:** 5,0 mm (.197)  
**Spring Force at Work. Stroke:** 1,5 N (5.4oz)  
**alternative:** 3,0 N (10.8oz); 5,0 N (18.1oz)

### Electrical Data

**Current Rating:** 5 - 8 A  
**R<sub>i</sub> typical:** < 30 mΩ

### Materials

**Plunger:** Steel, gold- or rhodium-plated  
**Barrel:** Brass, gold-plated  
**Spring:** Steel, gold-plated  
**Receptacle:** Brass, gold-plated

### Mounting Hole Size

**in CEM 1 with Receptacle:** ∅1,98 - 2,00 mm (.0780 - .0787)  
**in FR 4 with Receptacle:** ∅1,99 - 2,01 mm (.0783 - .0791)  
**without Receptacle:** ∅1,66 mm (.0654)

### Note:

The knurl on the barrel of the Test Probe guarantees sure fitting in the Receptacle or directly into the Probe Plate.

Please specify Special Designation „S“ when using Receptacle KS-712 30.

### Tools:

Insertion and Extraction Tools for GKS and KS see Page 118.

## Ordering Example

Series	Tip Material 2 = Steel	Tip Style	Tip Diameter (1/100 mm)	Plating A = Gold	Spring Force (dN)	Collar Height (mm)	Special Designation (alternative „S“)
--------	---------------------------	-----------	----------------------------	---------------------	----------------------	-----------------------	--

Test Probe:

G K S 7 1 0 2 2 0 1 0 0 R 1 5 0 7

Receptacle:

K S - 7 1 2 3 0

# GKS 714 / 098

Non-Rotating Test Probe

**Grid:**

≥ 5,08 mm

≥ 200 Mil

**Installation Height:** see below

**Recommended Stroke:** 4,0 / 6,0 mm (.157 / .236)

## Mounting and Functional Dimensions

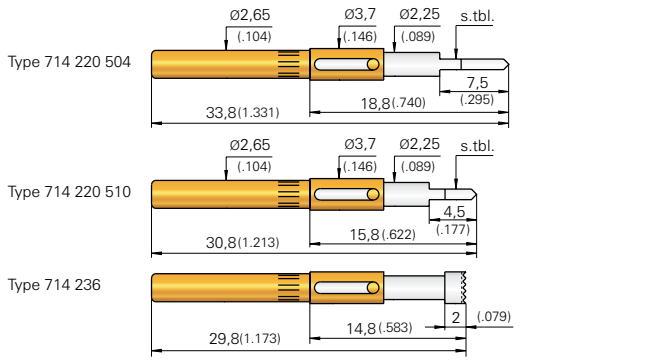

### GKS-714 ... 10

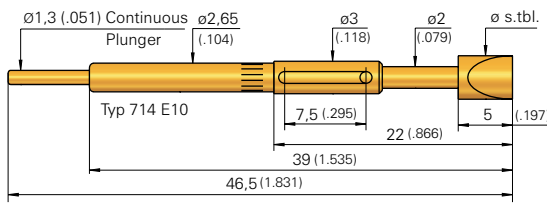

### GKS-098 ... 07

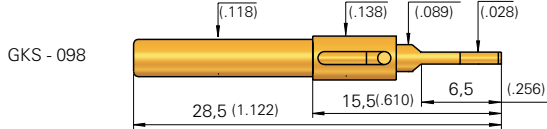

### Collar Height and Installation Height

The Installation Height at the Tip (Dimension without KS) is determined by the Collar Height and the Tip Length (see Table „Available Tip Styles“).

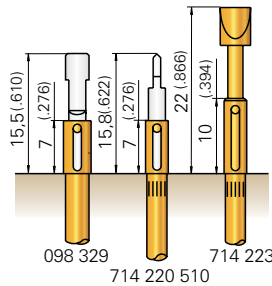

### Mechanical Data

**Spring Force at Work. Stroke:** 1,5 N (5.4oz)  
**alternativ:** 3,0 N (10.8oz); 5,0 N (18.1oz)

	714...07	714...10	098...07
<b>Working Stroke</b>	4,0 mm (.157)	6,0 mm (.236)	4,0 mm (.157)
<b>Maxim. Stroke</b>	5,0 mm (.197)	7,0 mm (.276)	5,0 mm (.197)

### Electrical Data

**Current Rating:** 8 - 10 A  
**R<sub>i</sub> typical:** < 30 mΩ

### Material

**Plunger:** Steel or BeCu, gold- or rhodium-plated  
**Barrel:** Brass, gold-plated  
**Spring:** Steel, gold-plated  
**Receptacle:** Brass, gold-plated

### Mounting Hole Size for GKS-714

**with Receptacle:** Ø 2,98 - 2,99 mm (.1173 - .1177)  
**without Receptacle:** Ø 2,66 mm (.1047)

### Mounting Hole Size for GKS-098

**with Receptacle:** Ø 3,48 - 3,49 mm (.1370 - .1374)

## Available Tip Styles

GKS-714 ... 07

Material	Tip Style	Plating	Install. and Functional Dim.	
			Collar Height	Install. Height
2 20		R	E 07	18,8 (.740)
2 20		R	E 07	15,8 (.622)
2 36		R	E 07	14,8 (.583)

## Available Tip Styles

GKS-714 ... 10

Material	Tip Style	Plating	Install. and Functional Dim.	
			Collar Height	Install. Height
2 22		A	E 10	22,0 (.866)
2 23		A	E 10	22,0 (.866)
2 23		A	E 10	22,0 (.866)

## Available Tip Styles

GKS-098 ... 07

Material	Tip Style	Plating	Install. and Functional Dim.	
			Collar Height	Install. Height
3 29		R	E 07	15,5 (.610)

### Note:

For the Test Probes series 714, the Receptacle of the series KS-714 23 are used (Dimension like KS-113 23, see Page 58). For the Test Probes of the series GKS-098, the Receptacles KS-103 23 are used (see Page 60).

### Tools:

Insertion and Extraction Tools for GKS and KS see Page 118.

## Ordering Example

Series	Tip Material	Tip Style	Tip Diameter (1/100 mm)	Plating	Spring Force (dN)	Collar Height (mm)
	A = Gold 2 = Steel 3 = BeCu					

Test Probe:

G K S 7 1 4 2 2 0 5 0 4 R 1 5 0 7

Test Probe:

G K S 0 9 8 3 2 9 3 0 0 R 1 5 0 7

Lamellar Plug for Type 714 E10:

S E - 5 0 3 (see drawing GKS-503 on Page 59. Cannot be used with KS)

Receptacle for GKS 714:

K S - 7 1 4 2 3

Receptacle for GKS 098:

K S - 1 0 3 2 3

**Grid:**  
 ≥ 5,08 mm  
 ≥ 200 Mil

**Installation Height:** 15,3 mm (.602)  
**Recommended Stroke:** 4,0 mm (.157)

### Mounting and Functional Dimensions

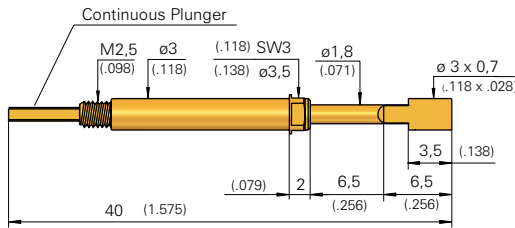

GKS-098 329 300 070 A xx02 ML

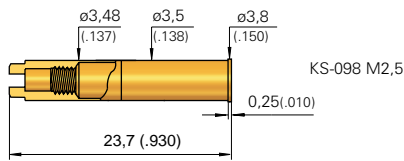

KS-098 M2,5

### Available Tip Styles

Material	Tip Style	Plating	Further Versions	
			∅	∅ (inch)
3	29	A		

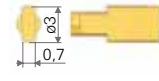

300 070

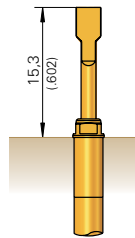

GKS-098 ... ML

#### Installation Height with KS

Install. Height „ML“: 15,3 mm (.602)

#### Mechanical Data

**Working Stroke:** 4,0 mm (.157)  
**Maximum Stroke:** 5,0 mm (.197)  
**Spring Force at Work. Stroke:** 1,5 N (5.4oz);  
 3,0 N (10.8oz)

#### Materials

**Plunger:** BeCu, gold-plated  
**Barrel:** Brass, gold-plated  
**Spring:** Steel, gold-plated  
**Receptacle:** Brass, gold-plated

#### Electrical Data

**Current Rating:** 10 A  
**R<sub>i</sub> typical:** < 30 mΩ

#### Mounting Hole Size

**in CEM 1 and FR 4:** ∅ 3,48 - 3,49 mm  
 (.1370 - .1374)

#### Note:

Further Versions on request.

#### Note:

When screwing the Test Probe into the Receptacle, the plunger will be secured against rotation. The flat surface at the end of the plunger fits into the slot at the end of the Receptacle.

The flat surface on the Plunger Tip is in the same alignment as the flat surface on the rear end of the Plunger.

#### Note:

GKS 098 ... M will be screwed into KS-098 M 2.5 using a special tool (see Page 170/171).

Recommended Screw-in Torque:  
 Min.: 10 Ncm / Max.: 20 Ncm

### Ordering Example

Series	Tip Material	Tip Style	Tip Diameter (1/100 mm)	Spade Width	Plating	Spring Force (dN)	Collar Height (mm)	Type
	3 = BeCu				A = Gold			

Test Probe:

G K S 0 9 8 3 2 9 3 0 0 0 7 0 A 1 5 0 2 M L

Receptacle:

K S - 0 9 8 M 2 . 5

# GKS 746 M

Screw-in Non-Rotating Test Probe with continuous Plunger

## Grid:

≥ 2,54 mm

≥ 100 Mil

Installation Height: 10,5 mm (.413)

Recommended Stroke: 4,0 mm (.157)

## Mounting and Functional Dimensions

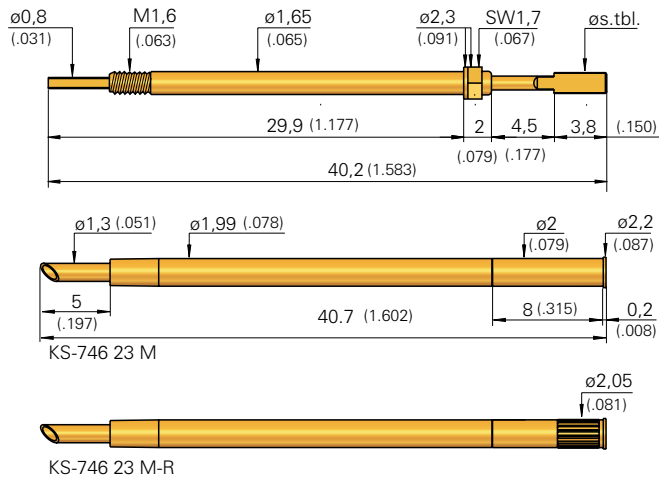

## Available Tip Styles

Material	Tip Style	Plating	Further Versions	
			∅	∅ (inch)
3 20		A		
3 20		A		
3 20		A		
3 20		A		
3 05 *		A		
2 14 *		A		

### Collar Height and Installation Height

The Installation Height of the Test Probe is determined by the Collar Height of the Receptacle.

Collar Height	Installation Height
02	10,5 mm (.413)

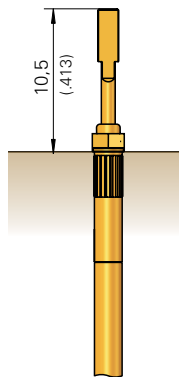

### Note:

\* Special Version: availability on request.

### Note:

When screwing the Test Probe into the Receptacle, the plunger will be secured against rotation. The flat surface at the end of the plunger fits into the slot at the end of the Receptacle.

The assembled unit is then vacuum-sealed and can therefore be used for leakage tests.

The flat surface on the Plunger Tip is in the same alignment as the flat surface on the rear end of the Plunger.

### Note:

GKS 746 ... M will be screwed into KS-746 23 M (-R) using special tools (see Page 170/171).

Recommended Screw-in Torque: Min.: 3 Ncm / Max.: 5 Ncm

### Mechanical Data

**Working Stroke:** 4,0 mm (.157)  
**Maximum Stroke:** 4,4 mm (.173)  
**Spring Force at Work. Stroke:** 1,5 N (5.4oz)  
**alternative:** 3,0 N (10.8oz)

### Materials

**Plunger:** Steel or BeCu, gold-plated  
**Barrel:** Brass, gold-plated  
**Spring:** Steel, gold-plated  
**Receptacle:** Brass, gold-plated

### Electrical Data

**Current Rating:** 5 - 8 A  
**R<sub>i</sub> typical:** < 30 mΩ

### Mounting Hole Size

**for KS-746 23 M**  
**in CEM 1 and FR 4:** ∅ 1,99 mm (.0783)  
**for KS-746 23 M-R**  
**in CEM 1 and FR 4:** ∅ 2,00 - 2,02 mm (.0787 - .0795)

## Ordering Example

Series	Tip Material 2 = Steel 3 = BeCu	Tip Style	Tip Diameter (1/100 mm) (A)	Spade Width (B)	Plating A = Gold	Spring Force (dN)	Collar Height (mm)	Type
--------	---------------------------------------	-----------	-----------------------------------	--------------------	---------------------	----------------------	-----------------------	------

Test Probe:

G K S 7 4 6 3 2 0 1 5 0 0 5 0 A 1 5 0 2 M

Receptacle:

K S - 7 4 6 2 3 M

Screw-in Tools:

K S - 7 4 6 2 3 M - R

Grid:  
 ≥ 4,50 mm  
 ≥ 180 Mil

Installation Height: 16,2 / 20,2 mm (.638 / .795)  
 Recommended Stroke: 4,0 mm (.157)

### Mounting and Functional Dimensions

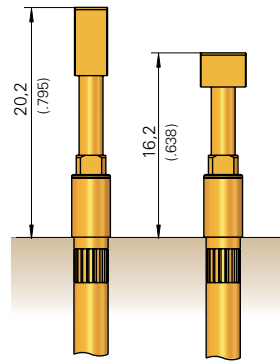
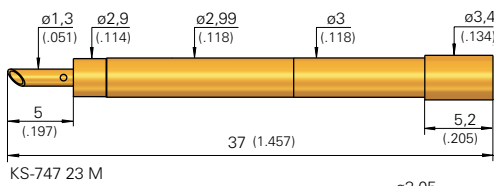
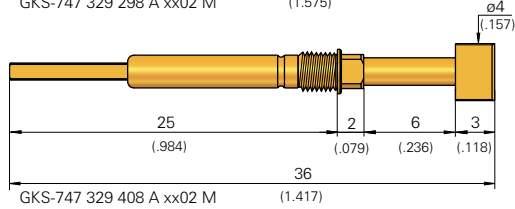
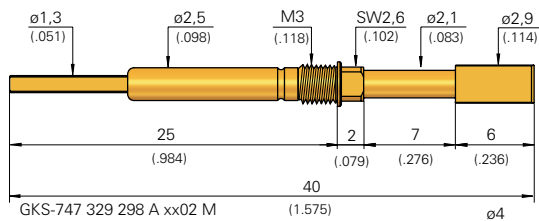

#### Collar Height and Installation Height

The Installation Height at the Tip (Dimension without KS) is determined by the Collar Height and the Tip Length (see Table „Available Tip Styles“).

#### Mechanical Data

**Working Stroke:** 4,00 mm (.157)  
**Maximum Stroke:** 5,0 mm (.197)  
**Spring Force at Work. Stroke:** 1,5 N (5.4oz);  
 3,0 N (10.8oz)

#### Materials

**Plunger:** Steel or BeCu, gold-plated  
**Barrel:** Brass, gold-plated  
**Spring:** Steel, gold-plated  
**Receptacle:** Brass, gold-plated

#### Electrical Data

**Current Rating:** 8 A  
**R<sub>i</sub> typical:** < 30 mΩ

#### Mounting Hole Size

**for KS-747 23 M**  
**in CEM 1 and FR 4:** ∅ 2,99 mm (.1177)  
**for KS-747 23 M-R**  
**in CEM 1 and FR 4:** ∅ 3,00 - 3,02 mm (.1181 - .1189)

### Available Tip Styles

Material	Tip Style	Plating	Install. Height with KS	
			Collar Height	Install. Height
3 29		A	02	20,2 (.795)
3 29		A	02	16,2 (.638)

#### Note:

When screwing the Test Probe into the Receptacle, the plunger will be secured against rotation. The flat surface at the end of the plunger fits into the slot at the end of the Receptacle.

The assembled unit is then vacuum-sealed and can therefore be used for leakage tests.

The flat surface on the Plunger Tip is in the same alignment as the flat surface on the rear end of the Plunger.

#### Note:

GKS 747 ... M will be screwed into KS-747 23 M (-R) using special tools (see Page 170/171).

Recommended Screw-in Torque:  
 Min.: 10 Ncm / Max.: 20 Ncm

### Ordering Example

Series	Tip Material 3 = BeCu	Tip Style	Tip Diameter (1/100 mm)	Plating A = Gold	Spring Force (dN)	Collar Height (mm)	Type
--------	--------------------------	-----------	----------------------------	---------------------	----------------------	-----------------------	------

Test Probe:

G K S 7 4 7 3 2 9 2 9 8 A 1 5 0 2 M

Receptacle:

K S - 7 4 7 2 3 M    K S - 7 4 7 2 3 M - R

# The new Test Fixtures Catalog

Our new Test Fixtures Catalog presents not only manual, pneumatic and vacuum-operated Test Fixtures, but especially also a choice of customized Test Fixtures. Based on these proven and remarkable solutions, you will get an impression of our many years of experience in customized Test Fixture design and manufacturing as well as the flexibility and know-how of INGUN.



*Ask for our Test Fixtures Catalog  
or take a look on our homepage  
[www.ingun.com](http://www.ingun.com).*

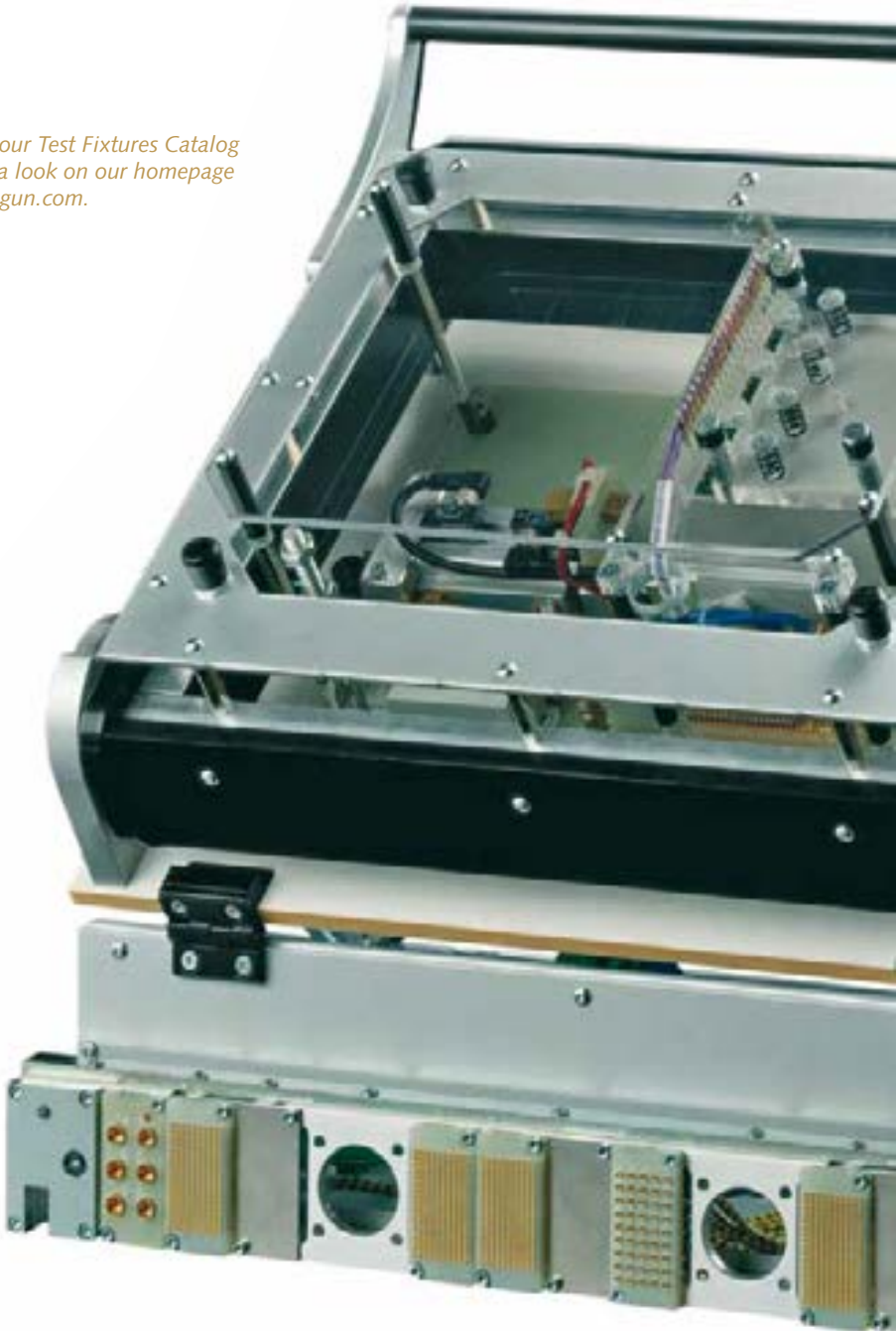



# Push-back Probes

Push-back Probes are used when checking the locking in of the connector contacts into connectors.

The Push-back Probes are available with spring forces up to 34N, which represents the spring-force demanded during testing connector contacts. They distinguish themselves with their rugged design and the necessary high installation heights.

To prevent the mainly rectangular/spade-type tip-styles from rotating, all Push-back Probes have a non-rotating design.

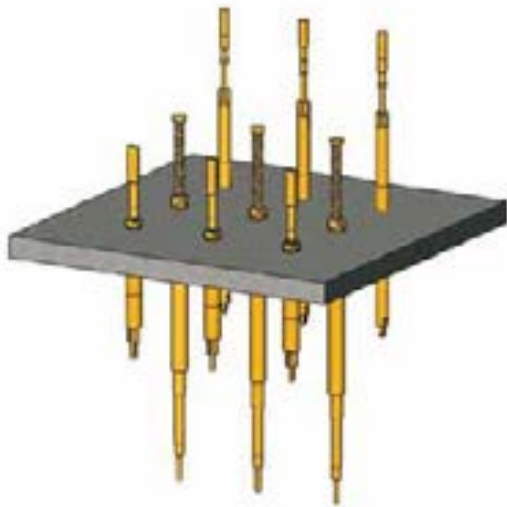

# Push-back Probes

VF 25	164
VF 3	165
VF 4	166
VF 5	167

# VF 25

Push-back Probe

## Grid:

≥ 2,54 mm

≥ 100 Mil

Installation Height: 40,5 mm (1.594)

Recommended Stroke: 5,0 mm (.197)

## Mounting and Functional Dimensions

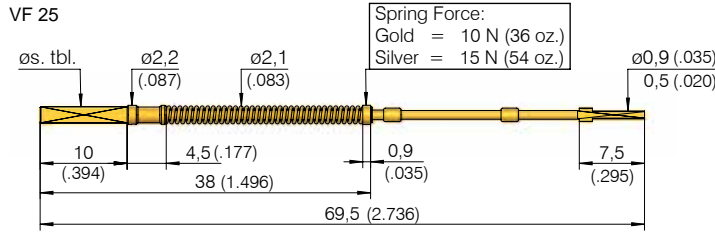

KS-VF 25  
also available pre-wired with wire  
AWG 34 (0,2 m): KS-VF 25 V

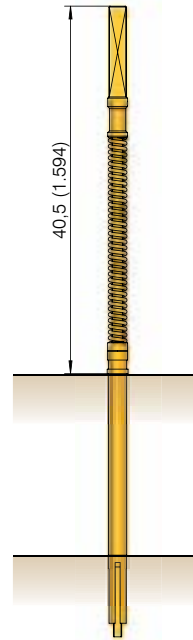
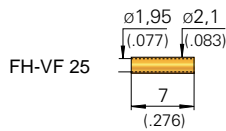
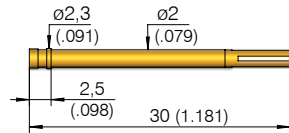

## Available Tip Styles

Material	Tip Style	Plating	Further Versions	
			$\varnothing$	$\varnothing$ (inch)
2	03	A	$\varnothing 2,20$ (.087)	
2	29	A	258	
2	29	A	193	

### Note:

The flat surface on the Plunger Tip is in the same alignment as the flat surface on the rear of the Plunger.

### Assembly Notice:

The patented design allows the test probe (consisting of plunger and spring) to be easily exchanged according to the following procedure:

- press the Plunger into the Receptacle until it reaches it's limit
- turn the Plunger 90°
- release the Plunger

In order to stabilize the Test Probe and to avoid damage to the Receptacle during mounting and dismounting, we recommend that either an additional guide plate be inserted underneath, or that the Guide Bush FH-VF 25 be attached to the end of the Receptacle after mounting, and subsequently soldered to secure it.

### Installation Height

Installation Height: 40,5 mm (1.594)

### Mechanical Data

Working Stroke: 5,0 mm (.197)

Maximum Stroke: 6,0 mm (.236)

Spring Force at Work. Stroke: 10 N (36oz);  
15 N (54oz)

Interchangeable Stroke: > 6,0 mm (.236)

### Materials

Plunger: Steel, gold-plated

Spring: Steel, gold-plated

Receptacle: Bronze, gold-plated

### Electrical Data

Current Rating: 5 A

R<sub>i</sub> typical: < 50 m $\Omega$

### Mounting Hole Size

in CEM 1 and FR 4:  $\varnothing 2,00$  mm (.0787)

## Ordering Example

Series	Tip Material 2 = Steel	Tip Style	Tip Diameter (1/100 mm)	Plating A = Gold	Spring Force (N)
--------	---------------------------	-----------	----------------------------	---------------------	---------------------

Test Probe:

V F 2 5 2 2 9 1 9 3 A 1 5 0

Receptacle:

K S - V F 2 5

Receptacle (pre-wired with 0,2m Wire AWG 34):

K S - V F 2 5 V

Guide Bush:

F H - V F 2 5

**Grid:**  
 ≥ 3,00 mm  
 ≥ 120 Mil

**Installation Height:** 40,5/44,5/46,5 mm (1.595/1.752/1.831)  
**Recommended Stroke:** 5,0 mm (.197)

### Mounting and Functional Dimensions

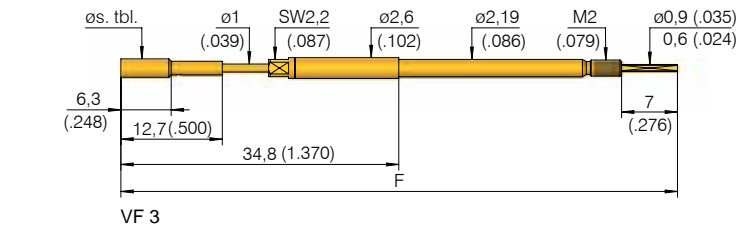

VF 3

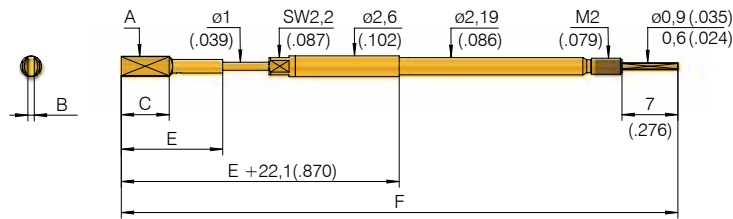

VF 3 220 ... (see table)

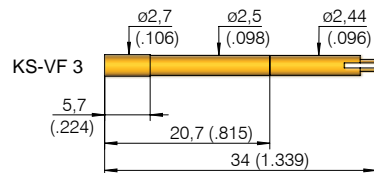

KS-VF 3

### Available Tip Styles

Material	Tip Style	Plating	Further Versions	
			∅	∅ (inch)
2 02		A	1,50 1,80 3,00	(.059) (.071) (.118)
2 03		A	2,20 3,00	(.087) (.118)
2 05		A	1,70	(.067)
2 06		A	2,70 3,00	(.106) (.118)
2 20		A		

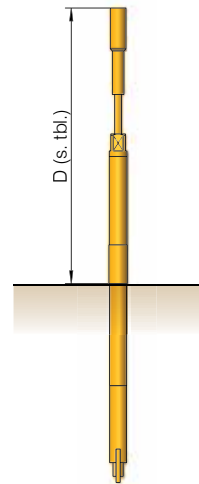

Part No.	A Tip-∅ mm (inch)	B Width of Spade in mm (inch)	C Length of Spade in mm (inch)	D Installation Height in mm (inch)	E Tip Height in mm (inch)	F Total Length mm (inch)
VF3 220 250 080 A 405 xx	2,5 (.098)	0,8 (.031)	6,0 (.236)	40,5 (1.594)	12,7 (.500)	69,7 (2.744)
VF3 220 250 050 A 405 xx	2,5 (.098)	0,5 (.020)	6,0 (.236)	40,5 (1.594)	12,7 (.500)	69,7 (2.744)
VF3 220 250 150 A 405 xx	2,5 (.098)	1,5 (.059)	6,0 (.236)	40,5 (1.594)	12,7 (.500)	69,7 (2.744)
VF3 220 190 050 A 405 xx	1,9 (.075)	0,5 (.020)	6,0 (.236)	40,5 (1.594)	12,7 (.500)	69,7 (2.744)
VF3 220 190 050 A 465 xx	1,9 (.075)	0,5 (.020)	12,0 (.472)	46,5 (1.831)	18,7 (.736)	75,7 (2.980)
VF3 220 190 080 A 405 xx	1,9 (.075)	0,8 (.031)	6,0 (.236)	40,5 (1.594)	12,7 (.500)	69,7 (2.744)
VF3 220 400 060 A 445 xx	4,0 (.160)	0,6 (.024)	10,0 (.394)	44,5 (1.752)	16,7 (.657)	73,7 (2.902)
VF3 220 220 120 A 405 xx	2,2 (.087)	1,2 (.047)	6,0 (.236)	40,5 (1.594)	12,7 (.500)	69,7 (2.744)
VF3 220 270 080 A 405 xx	2,7 (.106)	0,8 (.031)	6,0 (.236)	40,5 (1.594)	12,7 (.500)	69,7 (2.744)
VF3 220 250 080 A 465 xx	2,5 (.098)	0,8 (.031)	12,0 (.472)	46,5 (1.831)	18,7 (.736)	75,7 (2.980)

### Installation Height

Installation Height with KS: see Table

### Note:

The flat surface on the Plunger Tip is in the same alignment as the flat surface on the rear of the Plunger.

### Note:

VF 3 will be screwed into KS-VF 3 using special tools (see Page 170/171).

Recommended Screw-in Torque:  
 Min.: 3 Ncm / Max.: 5 Ncm

### Mechanical Data

**Working Stroke:** 5,0 mm (.197)  
**Maximum Stroke:** 5,5 mm (.217)  
**Spring Force at Work. Stroke:** 5,0 N (18oz);  
 10,0 N (34.6oz); 15,0 N (54oz)

### Materials

**Plunger:** Steel, gold-plated  
**Barrel:** Brass, gold-plated  
**Spring:** Steel, gold-plated  
**Receptacle:** Brass, gold-plated

### Electrical Data

**Current Rating:** 8 A  
**R<sub>i</sub> typical:** < 30 mΩ

### Mounting Hole Size

in CEM 1 and FR 4: ∅ 2,5 mm (.098)

### Ordering Example

Series	Tip Material	Tip Style	Tip Diameter (A)	Width of Spade (B)	Plating	Installation Height	Spring Force
	2 = Steel		(1/100 mm)	(B)	A = Gold	(1/10 mm)	(N)

Test Probe:

VF 3 2 20 250 080 A 405 05

Receptacle:

KS - VF 3

# VF 4

Push-back Probe

## Grid:

≥ 4,00 mm

≥ 157 Mil

Installation Height: 40,5 mm (1.594)

Recommended Stroke: 5,0 mm (.197)

## Mounting and Functional Dimensions

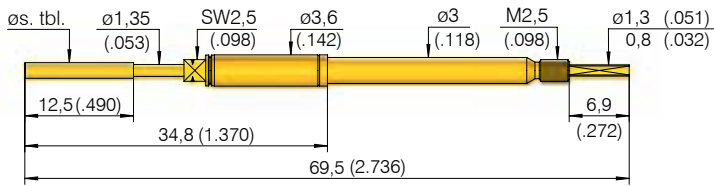

VF4

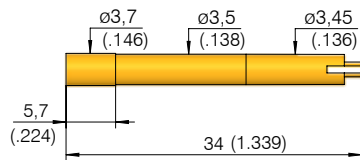

KS-VF4

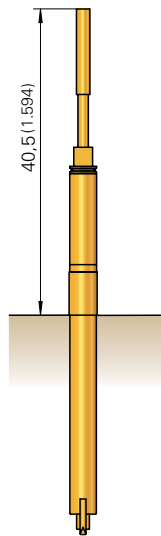

### Installation Height

Installation Height: 40,5 mm (1.594)

### Mechanical Data

**Working Stroke:** 5,0 mm (.197)  
**Maximum Stroke:** 5,5 mm (.220)  
**Spring Force at Work. Stroke:** 15 N (54oz)  
**alternative:** 25 N; 20 N (72oz)

### Materials

**Barrel:** Brass, gold-plated  
**Plunger:** Steel, gold-plated  
**Spring:** Steel, gold-plated  
**Receptacle:** Bronze, gold-plated

### Electrical Data

**Current Rating:** 8 A  
**R<sub>i</sub> typical:** < 30 mΩ

### Mounting Hole Size

in CEM 1 and FR 4: ø 3,50 mm (.1378)

## Available Tip Styles

Material	Tip Style	Plating	Further Versions	
			ø	ø (inch)
2 02		A	2,00	(.079)
2 02		A		
2 03		A	4,00	(.157)
2 06		A	4,00	(.157)
2 21*		A	0,80	(.031)
2 23*		A	1,60	(.063)

### Note:

Further tip styles are available on request.

### Note:

VF 4 are screwed into KS-VF 4 using special tools, see page 170/171.

Recommended Screw-in Torque:  
 Min.: 3 Ncm / Max.: 5 Ncm

### \* Note:

The flat surface on the Plunger Tip is in the same alignment as the flat surface on the rear of the Plunger.

## Ordering Example

Series	Tip Material 2 = Steel	Tip Style	Tip Diameter (1/100 mm)/ width of spade	Plating A = Gold	Spring Force (N)
--------	---------------------------	-----------	--	---------------------	------------------

Test Probe:

VF4 2 02 180 A 15

Receptacle:

KS-VF4

**Grid:**  
 ≥ 5,08 mm  
 ≥ 200 Mil

**Installation Height:** 36,7 mm (1.445)  
**Recommended Stroke:** 5,0 / 9,5 mm (.197 / .374)

### Mounting and Functional Dimensions

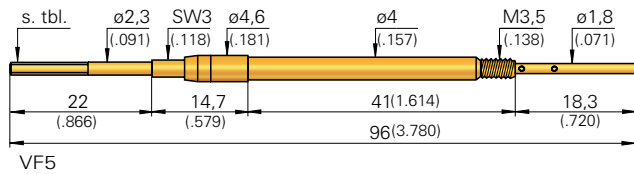

VF5

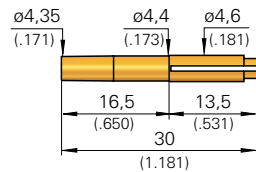

KS-VF5 030

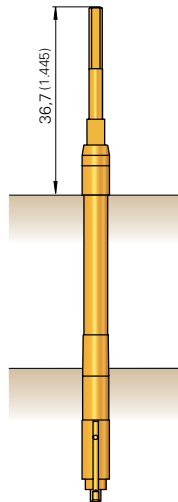

#### Installation Height

Installation Height with KS: 36,7 mm (1.445)

#### Mechanical Data

Spring Force at Work. Stroke	Pre-load	Working Stroke in mm (inch)	Maximum Stroke in mm (inch)
15 N (54oz)	2,7 N (10oz)	9,5 (.374)	10* (.394)/12 (.472)
20 N (72oz)	3,6 N (13oz)	9,5 (.374)	10* (.394)/12 (.472)
34 N (122oz)	10,0 N (36oz)	5,0 (.197)	6,5 (.256)

#### Materials

**Barrel:** Brass, gold-plated  
**Plunger:** BeCu, gold-plated  
**Spring:** Steel, gold-plated  
**Receptacle:** Brass, gold-plated

#### Mounting Hole Size

in CEM 1 and FR 4: Ø 4,0 resp. 4,4 mm (.1575) resp. (.1732)

#### Electrical Data

**Current Rating:** 10 A  
**R<sub>i</sub> typical:** < 30 mΩ

### Available Tip Styles

Material	Tip Style	Plating	Further Versions	
			Ø	Ø (inch)
3 20		A	1,40 (.055)	
3 20*		A	1,50* (.059)	
3 20		A	1,60 (.063)	
3 20		A	1,80 (.071)	

#### Note:

\* Maximum Stroke of VF5-320 150 A 096 with 15 N and 20 N = 10,0 mm (.394)

#### Note:

VF 5 are screwed into KS-VF5 030 using special tools, see page 170/171.

#### Recommended Screw-in Torque:

Min.: 10 Ncm / Max.: 20 Ncm

#### Note:

To recognize the spring force, the flat areas for the spanner are marked with notches:

- 1 notch 15 N (54oz)
- 2 notches 20 N (72oz)
- 3 notches 34 N (122oz)

### Ordering Example

Series	Tip Material	Tip Style	Tip Diameter (1/100 mm)	Plating	Total Length (dN)	Spring Force (N)
VF5	3 = BeCu	20	150	A = Gold	096	20

Test Probe:

VF5 3 20 150 A 096 20

Receptacle:

KS - VF5 030





# Tools

---

By using Torque Tools it is ensured that the recommend screw-in torque is abided by. Not only continuous adjustable Torque Tools are available but also tools with a fixed set torque.

The new 1/4"-Bit Insert System guarantees a high level of flexibility, i.e. all Screw-in Tools can be used with the various Torque Tools.

Naturally the Bit Tools can be used without the Torque Screwing Tool, for e.g. the removal of the Probes in tightly spaced conditions etc.



# Tools

BIT / DW / SW

170/171

**Insertion and Extraction Tool – see page 118.**

# Screw-in Tools with a system

Drawings for Screw-in and Bit-Tools see on Page 171.  
Drawings for Insertion Tools see on Page 118.

Series	Plunger Tip-Ø	Bit-Tool	Ø A (mm)	Ø B (mm)	C (mm)	Torque Key			Recommend screw-in torque		Insertion Tools for Receptacles
						pre-set	freely adjustable		min.	max.	
GKS-050 M	≤ 1,1 mm	BIT-GKS-050 M-B	1,5	5	30	DW-1-S	-	-	0,5 Ncm	1 Ncm	SW-KS-080
GKS-075 M	≤ 1,1 mm	BIT-GKS-075 M-B	2,3	5	30	DW-1-S	-	-	0,5 Ncm	1 Ncm	SW-KS-075 G
GKS-075 M	≤ 1,5 mm	BIT-GKS-075 M	2,3	5	30	DW-1-S	-	-	0,5 Ncm	1 Ncm	SW-KS-075 G
GKS-087 M	≤ 1,1 mm	BIT-GKS-050 M-B	1,5	5	30	DW-1-S	-	-	0,5 Ncm	1 Ncm	SW-KS-050 G
GKS-098 M	≤ 3,1 mm	BIT-GKS-503 M-B	4,8	4,8	-	DW-20	DW-5-40	DW-20-120	10 Ncm	20 Ncm	SW-GKS
GKS-103 M	≤ 3,1 mm	BIT-GKS-503 M-B	4,8	4,8	-	DW-20	DW-5-40	DW-20-120	10 Ncm	20 Ncm	SW-KS-103
GKS-103 M	≤ 4,1 mm	BIT-GKS-503 M	5,5	6	27	DW-20	DW-5-40	DW-20-120	10 Ncm	20 Ncm	SW-KS-103
GKS-112 MD	≤ 2,0 mm	BIT-GKS-112 M-B-FP	2,8	5	30	DW-5-S	DW-5-40	-	3 Ncm	5 Ncm	SW-KS-112
GKS-112 M	≤ 2,0 mm	BIT-GKS-112 M-B	2,7	5	30	DW-5-S	DW-5-40	-	3 Ncm	5 Ncm	SW-KS-112
GKS-112 M	≤ 3,5 mm	BIT-GKS-112 M	4,3	6	27	DW-5-S	DW-5-40	-	3 Ncm	5 Ncm	SW-KS-112
GKS-113 M	≤ 3,0 mm	BIT-GKS-113 M-B	4,8	4,8	-	DW-20	DW-5-40	DW-20-120	10 Ncm	20 Ncm	SW-KS-113
GKS-113 M	≤ 4,2 mm	BIT-GKS-113 M	5,3	6	27	DW-20	DW-5-40	DW-20-120	10 Ncm	20 Ncm	SW-KS-113
GKS-204 M	≤ 2,0 mm	BIT-GKS-112 M-B	2,7	5	30	DW-5-S	DW-5-40	-	3 Ncm	5 Ncm	SW-KS-112
GKS-212 M	≤ 2,0 mm	BIT-GKS-212 M	2,7	6	26	DW-5-S	DW-5-40	-	3 Ncm	5 Ncm	SW-GKS
GKS-313 M	≤ 3,0 mm	BIT-GKS-113 M-B	4,8	4,8	-	DW-20	DW-5-40	DW-20-120	10 Ncm	20 Ncm	SW-KS-113
GKS-427 M	≤ 2,0 mm	BIT-GKS-112 M-B	2,7	5	30	DW-5-S	DW-5-40	-	3 Ncm	5 Ncm	SW-KS-112
GKS-500 M	> 0 mm	BIT-GKS-500 M	3,5	6	27	DW-20	DW-5-40	DW-20-120	10 Ncm	20 Ncm	SW-GKS
GKS-503 M	≤ 3,1 mm	BIT-GKS-503 M-B	4,8	4,8	-	DW-20	DW-5-40	DW-20-120	10 Ncm	20 Ncm	SW-KS-103
GKS-503 M	≤ 4,1 mm	BIT-GKS-503 M	5,5	6	27	DW-20	DW-5-40	DW-20-120	10 Ncm	20 Ncm	SW-KS-103
GKS-746 M	≤ 2,0 mm	BIT-GKS-112 M-B	2,7	5	30	DW-5-S	DW-5-40	-	3 Ncm	5 Ncm	SW-KS-112
GKS-747 M	≤ 4,0 mm	BIT-GKS-747 M	5	6	28	DW-20	DW-5-40	DW-20-120	10 Ncm	20 Ncm	SW-KS-112
GKS-761 M	≤ 2,0 mm	BIT-GKS-112 M-B	2,7	5	30	DW-5-S	DW-5-40	-	3 Ncm	5 Ncm	SW-GKS
GKS-803 M	≤ 3,1 mm	BIT-GKS-503 M-B	4,8	4,8	-	DW-20	DW-5-40	DW-20-120	10 Ncm	20 Ncm	SW-KS-103
GKS-803 M	≤ 4,1 mm	BIT-GKS-503 M	5,5	6	27	DW-20	DW-5-40	DW-20-120	10 Ncm	20 Ncm	SW-KS-103
GKS-854 M	≤ 4,0 mm	BIT-HSS-150 M	5,5	6	28	DW-20	DW-5-40	DW-20-120	10 Ncm	20 Ncm	SW-GKS
GKS-899 M	≤ 1,5 mm	BIT-GKS-899 M-B	2,4	5	30	DW-3-S	-	-	2 Ncm	3 Ncm	SW-KS-100
GKS-899 M	≤ 2,0 mm	BIT-GKS-899 M	2,8	6	27	DW-3-S	-	-	2 Ncm	3 Ncm	SW-KS-100
GKS-913 M	≤ 3,0 mm	BIT-GKS-913 M-B	4,8	4,8	-	DW-5-S	DW-5-40	-	5 Ncm	10 Ncm	SW-KS-113
GKS-913 M	≤ 3,6 mm	BIT-GKS-913 M	5,3	6	27	DW-5-S	DW-5-40	-	5 Ncm	10 Ncm	SW-KS-113
GKS-967 M	≤ 1,3 mm	* BIT-GKS-967 M-B-K	5,3	5,3	30	DW-5-S	DW-5-40	-	3 Ncm	5 Ncm	SW-GKS
HSS-118 M	≤ 2,0 mm	BIT-GKS-112 M-B	2,7	5	30	DW-5-S	DW-5-40	-	3 Ncm	5 Ncm	SW-KS-112
HSS-118 M	≤ 3,5 mm	BIT-GKS-112 M	4,3	6	27	DW-5-S	DW-5-40	-	3 Ncm	5 Ncm	SW-KS-112
HSS-120 M	≤ 3,0 mm	BIT-GKS-113 M-B	4,8	4,8	-	DW-20	DW-5-40	DW-20-120	10 Ncm	20 Ncm	SW-KS-113
HSS-120 M	≤ 4,2 mm	BIT-GKS-113 M	5,3	6	27	DW-20	DW-5-40	DW-20-120	10 Ncm	20 Ncm	SW-KS-113
HSS-150 M	≤ 3,0 mm	BIT-HSS-150 M-300	5,5	6	28	DW-20	DW-5-40	DW-20-120	10 Ncm	20 Ncm	SW-GKS
HSS-150 M	≤ 4,0 mm	BIT-HSS-150 M	5,5	6	28	DW-20	DW-5-40	DW-20-120	10 Ncm	20 Ncm	SW-GKS
HSS-520 M	≤ 3,0 mm	BIT-GKS-913 M-B	4,8	4,8	-	DW-5-S	DW-5-40	-	5 Ncm	10 Ncm	SW-KS-113
HSS-520 M	≤ 3,6 mm	BIT-GKS-913 M	5,3	6	27	DW-5-S	DW-5-40	-	5 Ncm	10 Ncm	SW-KS-113
HSS-552 M	≤ 4,0 mm	BIT-HSS-150 M	5,5	6	28	DW-20	DW-5-40	DW-20-120	10 Ncm	20 Ncm	SW-GKS
HSS-827 M	≤ 2,0 mm	BIT-GKS-112 M-B	2,7	5	30	DW-5-S	DW-5-40	-	3 Ncm	5 Ncm	SW-KS-112
PKS-171 M	≤ 1,6 mm	BIT-PKS-171 M-B	2,7	6	26	DW-3-S	-	-	2 Ncm	3 Ncm	SW-KS-100
PKS-355 M	≤ 2,5 mm	BIT-SKS-465 M-B	4	4	-	DW-20	DW-5-40	DW-20-120	10 Ncm	20 Ncm	SW-KS-113
PKS-388 M	≤ 3,7 mm	BIT-PKS-388 M-B	5	6	30	DW-20	DW-5-40	DW-20-120	10 Ncm	20 Ncm	SW-GKS
PSK-350 M	≤ 2,5 mm	BIT-SKS-465 M-B	4	4	-	DW-20	DW-5-40	DW-20-120	10 Ncm	20 Ncm	SW-KS-113
NEW SKS-215 M/MF	≤ 2,0 mm	BIT-GKS-112 M-B	2,7	5	30	DW-5-S	DW-5-40	-	3 Ncm	5 Ncm	SW-KS-112
NEW SKS-215 M/MF	≤ 3,5 mm	BIT-GKS-112 M	4,3	6	27	DW-5-S	DW-5-40	-	3 Ncm	5 Ncm	SW-KS-112
SKS-435 M	≤ 3,1 mm	BIT-GKS-503 M-B	4,8	4,8	-	DW-20	DW-5-40	DW-20-120	10 Ncm	20 Ncm	SW-KS-103
SKS-435 M	≤ 4,1 mm	BIT-GKS-503 M	5,5	6	27	DW-20	DW-5-40	DW-20-120	10 Ncm	20 Ncm	SW-KS-103
SKS-465 MF	≤ 2,5 mm	BIT-SKS-465 M-B	4	-	-	DW-5-S	DW-5-40	-	3 Ncm	5 Ncm	SW-KS-113
SKS-465 MF	≤ 3,0 mm	BIT-SKS-465 M	4	6	27	DW-5-S	DW-5-40	-	3 Ncm	5 Ncm	SW-KS-113
SKS-465 SF	> 0 mm	BIT-SKS-465 S	3	6	28	DW-5-S	DW-5-40	-	3 Ncm	5 Ncm	SW-KS-113

\* L<sub>total</sub> = 47 mm

Series	Plunger Tip-Ø	Bit Tool	Ø A (mm)	Ø B (mm)	C (mm)	Torque Key			Recommend screw-in torque		Insertion Tools for Receptacles
						pre-set	freely adjustable		min.	max.	
T-112 M	≤ 2,0 mm	BIT-GKS-112 M-B	2,7	5	30	DW-5-S	DW-5-40	-	3 Ncm	5 Ncm	SW-KS-112
T-112 M	≤ 3,5 mm	BIT-GKS-112 M	4,3	6	27	DW-5-S	DW-5-40	-	3 Ncm	5 Ncm	SW-KS-112
T-113 M	≤ 3,0 mm	BIT-GKS-113 M-B	4,8	4,8	-	DW-20	DW-5-40	DW-20-120	10 Ncm	20 Ncm	SW-KS-113
T-113 M	≤ 4,2 mm	BIT-GKS-113 M	5,3	6	27	DW-20	DW-5-40	DW-20-120	10 Ncm	20 Ncm	SW-KS-113
T-113 M	≤ 5,0 mm	BIT-T-113 M	6	-	-	DW-20	DW-5-40	DW-20-120	10 Ncm	20 Ncm	SW-KS-113
<b>NEW</b> T-888 M	3,0 - 4,0 mm	BIT-T-888 M-3	3,5	6	23	DW-20	DW-5-40	DW-20-120	10 Ncm	20 Ncm	SW-KS-113
<b>NEW</b> T-888 M	4,0 - 4,7 mm	BIT-T-888 M	5	6	23	DW-20	DW-5-40	DW-20-120	10 Ncm	20 Ncm	SW-KS-113
<b>NEW</b> T-888 M	5,0 mm	BIT-T-912 M	2,6	6	23	DW-20	DW-5-40	DW-20-120	10 Ncm	20 Ncm	SW-KS-113
T-899 M	≤ 1,5 mm	BIT-GKS-899 M-B	2,4	5	30	DW-3-S	-	-	2 Ncm	3 Ncm	SW-KS-100
<b>NEW</b> T-912 M	2,0 - 3,5 mm	BIT-T-912 M	2,6	6	23	DW-5-S	DW-5-40	-	3 Ncm	5 Ncm	SW-KS-112
VF-3	≤ 2,1 mm	BIT-VF3 M-B	3,3	5	29	DW-5-S	DW-5-40	-	3 Ncm	5 Ncm	SW-GKS
VF-3	≤ 3,0 mm	BIT-VF3 M	4	6	27	DW-5-S	DW-5-40	-	3 Ncm	5 Ncm	SW-GKS
VF-4	≤ 2,5 mm	BIT-VF4 M-B	4	4	-	-	DW-5-40	-	5 Ncm	10 Ncm	SW-KS-103
VF-4	≤ 4,0 mm	BIT-VF4 M	4	6	27	-	DW-5-40	-	5 Ncm	10 Ncm	SW-KS-103
VF-5	≤ 3,0 mm	BIT-GKS-113 M	5,3	6	27	DW-20	DW-5-40	DW-20-120	5 Ncm	20 Ncm	on Request

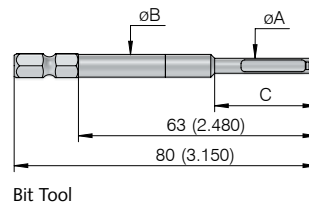
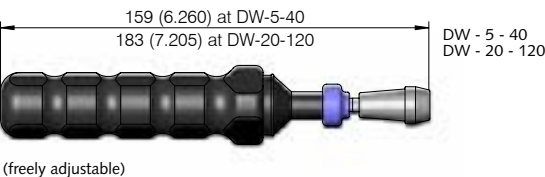
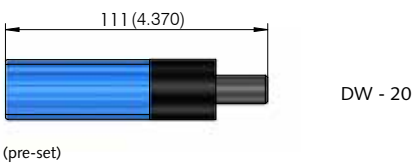
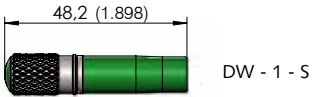

Application example:  
BIT-GKS-113 M with Test Probe GKS 113 M



## Ordering Example

Bit-tool for screw-in Probe:

Handle without ratchet:

Torque keys pre-set:

Torque keys freely adjustable:

BIT - GKS - 112 M - B

DW - S

DW - 1 - S

DW - 3 - S

DW - 5 - S

DW - 20

DW - 5 - 40

DW - 20 - 120

Send copied fax-form to: +49 7531 8105-65

**To:**  
**INGUN Prüfmittelbau GmbH**  
 Probe Design Dept.  
 Max-Stromeyer-Straße 162  
 78467 Konstanz  
 Germany

**From:**

\_\_\_\_\_  
 COMPANY

\_\_\_\_\_  
 DEPT.

\_\_\_\_\_  
 NAME

\_\_\_\_\_  
 STREET

\_\_\_\_\_  
 POSTE CODE / COUNTRY

\_\_\_\_\_  
 FAX

\_\_\_\_\_  
 TEL.

\_\_\_\_\_  
 E-MAIL

## Your Requirement – Our Solution!

### Features

Short description / Operation Example:

\_\_\_\_\_

\_\_\_\_\_

\_\_\_\_\_

\_\_\_\_\_

\_\_\_\_\_

\_\_\_\_\_

\_\_\_\_\_

\_\_\_\_\_

**Standard Test Probe**

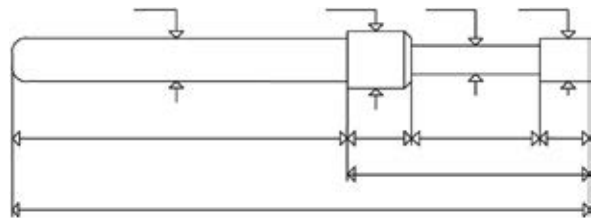

**Srew-in Step Probe**

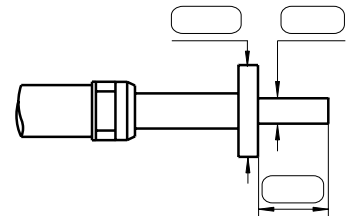

**Tip:**

**Electrical data:**

Tip-style: \_\_\_\_\_  $I_{max}$  \_\_\_\_\_ A

Material: \_\_\_\_\_  $U_{max}$  \_\_\_\_\_ V

Plating: \_\_\_\_\_  $R_{max}$  \_\_\_\_\_  $\Omega$

Grid:	Stroke mm (inch)	Force (N)
Pre-Load	/	
Working Stroke		
Max. Stroke		
Required life-expectancy:		

### Environmental Conditions and Application Range:

Temperature range from: \_\_\_\_\_ °C to: \_\_\_\_\_ °C

- |  |  |                                |
|--|--|--------------------------------|
| <input type="checkbox"/> Rough Operation/Usage | <input type="checkbox"/> Contamination | <input type="checkbox"/> Other |
| <input type="checkbox"/> High Humidity         | <input type="checkbox"/> Vibration     |                                |
| <input type="checkbox"/> Radial Force          | <input type="checkbox"/> Snap Effect   |                                |

**We are also interested in:**

- |  |                                    |
|--|------------------------------------|
| <input type="checkbox"/> Test Fixtures | <input type="checkbox"/> RF-Probes |
|--|------------------------------------|

# INGUN Test Probes according to Series

Series	Page	Series	Page	Series	Page
Fixtures Accessories <small>NEW</small>	114–116	GKS-364	62	HSS-520/520M	106
BIT/DW/SW/Tools	170/171	GKS-365	63	HSS-552 M	146
DKS-050	74	GKS-366	63	HSS-827 M	129
DKS-075	74	GKS-412	54	KS-040 WL	38
DKS-100	74	GKS-414	113	KS-075 WL	38
E-050 <small>NEW</small>	20	GKS-416	113	KS-100 WL	38
E-075 <small>NEW</small>	20	GKS-422	53	KS-112	50
E-100 <small>NEW</small>	21	GKS-427 M	129	KS-550 WL	38
E-422 <small>NEW</small>	21	GKS-500 M	139	Contact Terminal KT <small>NEW</small>	111
GKS-001	33	GKS-502	57	PKS Accessories	94/95
GKS-002	34	GKS-503/503M	61	PKS-171	87
GKS-003	35	GKS-504	113	PKS-200	88
GKS-004	36	GKS-550	38/40	PKS-220	89
GKS-005	37	GKS-710	157	PKS-299	90
GKS-015	25	GKS-713	76	PKS-300	91
GKS-035	30	GKS-714	158	PKS-355 M	84
GKS-038	42	GKS-725	75	PKS-388 M	85
GKS-040	24	GKS-746 M	160	PKS-399	92
GKS-041	42	GKS-747 M	161	PKS-420	93
GKS-050	25	GKS-761 M	69	PSK-350 M	86
GKS-050 Bead Probe <small>NEW</small>	40	GKS-803 M	156	SKS-100	78
GKS-050 M	126	GKS-854/854 M	138	SKS-215	79
GKS-061	42	GKS-899 M	130	SKS-215 M/MF <small>NEW</small>	148
GKS-064	66	GKS-912	52	SKS-415	80
GKS-069	45	GKS-913	59	SKS-419	82
GKS-075	26/27	GKS-913 M	142	SKS-425	81
GKS-075 Bead Probe <small>NEW</small>	40	GKS-925 TJA (TestJet)	112	SKS-429	82
GKS-075 M	128	GKS-938	110	SKS-435 M	151
GKS-079	46	GKS-941	66	SKS-465 MF	149
GKS-080	43	GKS-945	110	SKS-465 SF	150
GKS-081	44	GKS-946	110	SW/ZW/AW/Tools <small>NEW</small>	118
GKS-087 M	127	GKS-961	69	T-112 M	133/134
GKS-098	158	GKS-967/967M	68	T-113 M <small>NEW</small>	136/137
GKS-098 M	159	GKS-970	69	T-888 M <small>NEW</small>	136/137
GKS-100 <small>NEW</small>	28/29	GKS-986	66	T-899 M	131
GKS-100 Bead Probe <small>NEW</small>	40	HF/Digital <small>NEW</small>	152/154	T-912 M <small>NEW</small>	133/134
GKS-100 306 229 ...	110	HFS-010	100	VF 25	164
GKS-100 307 150 ...	110	HFS-110	101	VF 3	165
GKS-100 357 150 ...	110	HFS-PCB <small>NEW</small>	98	VF 4	166
GKS-101	32	HFS-Connectors <small>NEW</small>	99	VF 5	167
GKS-102	56	HMS-075	112	VS-112	51
GKS-102	113	HMS-100	112	VS-112 M	132
GKS-103/103M	60	HMS-422	112		
GKS-112	51	HSS-118	104		
GKS-112 MD	72	HSS-118 M <small>NEW</small>	144		
GKS-112 M	132	HSS-120	105		
GKS-113	58	HSS-120 M	145		
GKS-113 M	135	HSS-150	107		
GKS-135	31	HSS-150 M	146		
GKS-135 Bead Probe <small>NEW</small>	40	HSS-2259	108		
GKS-181	47	HSS-2513	108		
GKS-204/204 M	55	HSS-2516	108		
GKS-212 M	140	HSS-2526	108		
GKS-313 M	141	HSS-2532	108		

Visit us on the internet under:  
[www.ingun.com](http://www.ingun.com)

### Headquarter

INGUN Germany

### Subsidiaries

INGUN Benelux  
INGUN China  
INGUN India  
INGUN Mexico  
INGUN Switzerland  
INGUN UK  
INGUN USA

### Europe

Austria  
Benelux  
Bosnia-Herzegovina  
Croatia  
Czech Republic  
Denmark  
Estonia  
Finland  
France  
Germany  
Hungary  
Italy  
Norway  
Poland  
Portugal  
Romania  
Serbia  
Slovenia  
Slovak Republic  
Spain  
Sweden  
Switzerland  
Turkey  
United Kingdom

### Asia

China  
Hong Kong  
India  
Israel  
Japan  
Korea  
Malaysia  
Taiwan  
Thailand  
Vietnam

### Africa

South Africa  
Tunisia

### Australia

Australia  
New Zealand

### America

Argentina  
Brazil  
Canada  
Mexico  
USA

The addresses of the International Agencies  
can be found under [www.ingun.com](http://www.ingun.com)

**ingun**<sup>®</sup>

**INGUN Prüfmittelbau GmbH**

Max-Stromeyer-Straße 162

78467 Konstanz

Germany

Tel. +49 7531 8105-0

Fax +49 7531 8105-65

[info@ingun.com](mailto:info@ingun.com)

[www.ingun.com](http://www.ingun.com)